

PRIMUS

GLASSCHIEBETÜRBESCHLÄGE



GLASSYSTEME



ästhetisch – robust – langlebig

GLASSCHIEBETÜRBESCHLÄGE VON SWS GLASSYSTEME

»» MODELLE 2100 + 2200

Mit unseren Systemen realisieren Sie Schaukästen und Vitrinen. Die Technik ist bewährt und alle Komponenten sind robust und langlebig.





INHALT

SCHIEBETÜRBESCHLÄGE

Modell 2100	S.06
Modell 2200.....	S.18

ZUBEHÖR

Anwendungs- & Montagezubehör	S.22
------------------------------------	------



Oberflächen

Material: Zink



ZN1

matt-
verchromt

ZN3

glanz-
verchromt

Material: Aluminium



E3/1

matt-
verchromt

E3/50

glanz-
verchromt

E6/EV1

Alu-Optik

Material: Stahl



ST8

verzinkt

Material: Kunststoff



KU0

transparent

KU1

weiß

KU2

braun

KU4

silbergrau

KU6

matt-
verchromt

SCHIEBETÜRBESCHLAG MODELL 2100 für Plattendicke 5-8 mm

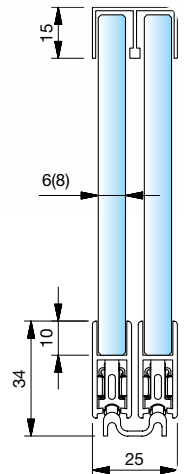
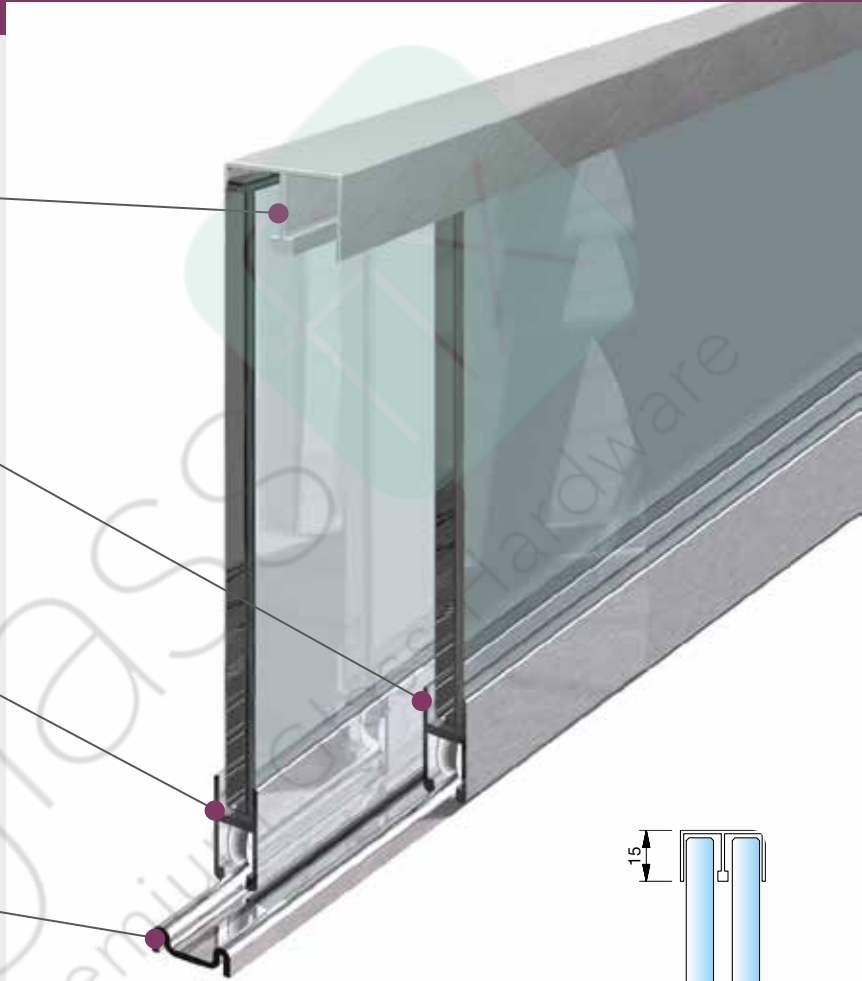
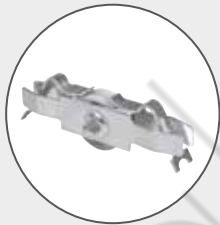
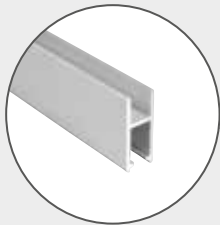
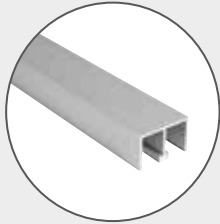

TECHNISCHE ANGABEN

Maximale Belastung pro Flügel

2 x 2103 ST8 = ca. 25 kg

4 x 2103 ST8 = ca. 50 kg

Berechnung des Glasmaßes ohne Klemmprofil:

Einbauhöhe - 31 mm = Glasmaß

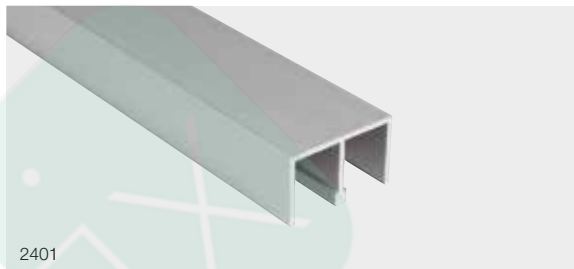
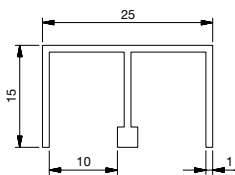

2401



2411

Obere Doppel-U-Führungsschiene



ungebohrt

Material: Aluminium, naturfarbig

Art.-Nr.		Ausführung
2401E6EV1-5M	5-8 mm	
2411E6EV1-5M	5-8 mm	samtiert, ruhig laufend

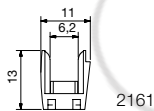

2161

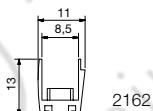

2162

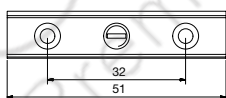
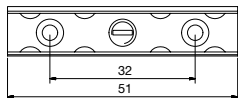

2161



2162

Aushängesicherung/Klapperschutz



Material: Kunststoff

Art.-Nr.		Oberfläche
2161KU0	6 mm	transparent
2162KU0	8 mm	transparent



2756

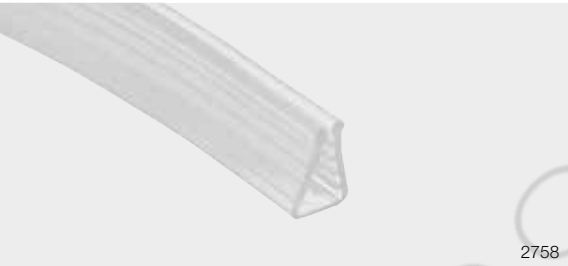

2758

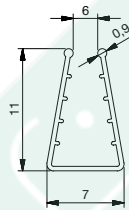

2756

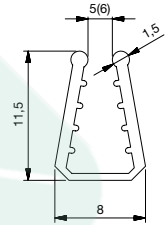

2758

Klemmprofil



Material: Kunststoff

Art.-Nr.		Laufschuh	Oberfläche
2756KU0	6 mm	2122	transparent
2758KU0	5 mm	2122	transparent
2758KHU0	6 mm	2124	transparent



2122



2124

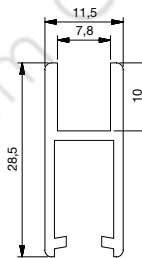

2122

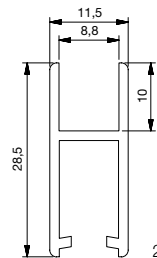

2124

Laufschuh



mit Schutzfolie

Material: Aluminium

Art.-Nr.		Oberfläche
2122E6EV1-5M	5-6 mm	naturfarbig
2124E6EV1-5M	6-8 mm	naturfarbig

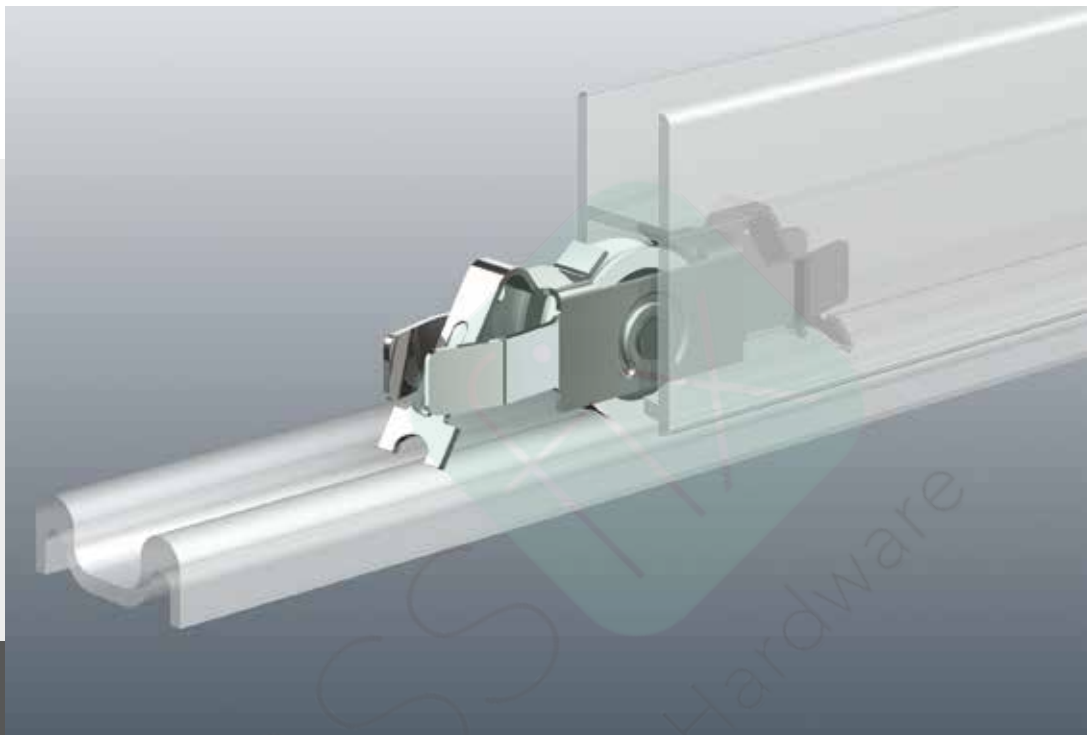

Rolleneinsatz



mit kunststoffummantelter Stahlkugellagerrolle
 Material: Stahl

Art.-Nr.	Oberfläche
2103ST8	verzinkt

Zubehör 2145 auf S. 10

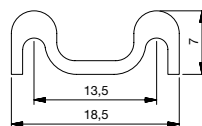

Untere Doppelaufschiene

mit Doppelklebeband

Art.-Nr.	Oberfläche
2007E6EV1-5M	naturfarbig

Zubehör 5015, 5016 auf S. 26

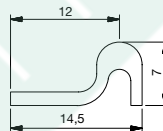
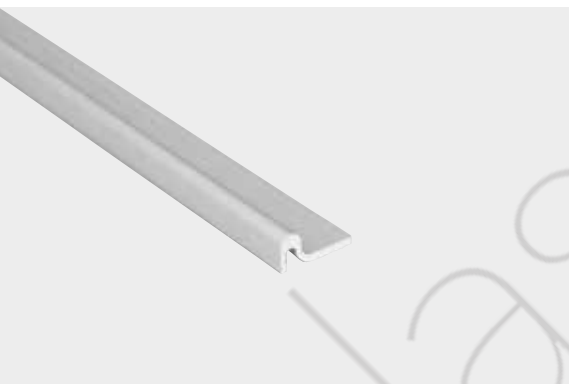

Untere Einbahnlaufschiene

mit Doppelklebeband

Art.-Nr.	Oberfläche
2008E6EV1-5M	naturfarbig

Zubehör 5015, 5016 auf S. 26



Montagewerkzeug

aus Makrolon für Rolleneinsatz 2103

Material: Kunststoff

Art.-Nr.	Oberfläche
2145KU0	transparent

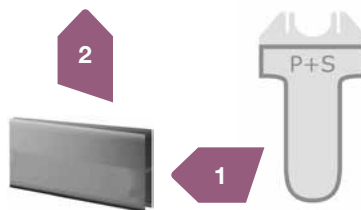

Anleitung

1. Rolleneinsatz auf das Montagewerkzeug aufstecken und in den Laufschuh einschieben
2. Montagewerkzeug abziehen

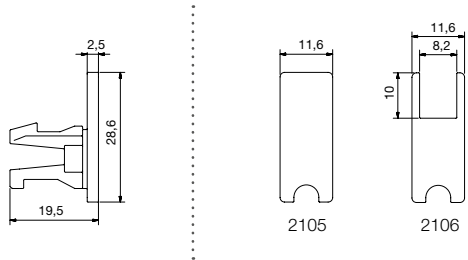

Endstück 

Material: Kunststoff

Art.-Nr.	Oberfläche	Ausführung
2105KU6	mattverchromt	
2106KU6	mattverchromt	ausgeklinkt





2159



2160

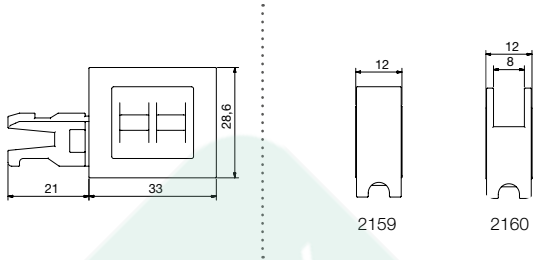

2159

2160

Laufschiuhgriff



Material: Kunststoff
 Plattendicke: 5-8 mm

Art.-Nr.	Oberfläche	Ausführung
2159KU6	mattverchromt	
2160KU6	mattverchromt	ausgeklinkt



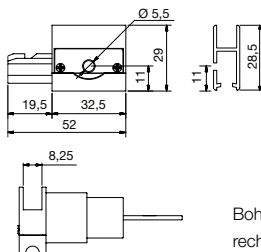

Bohrbild für Laufschuh
rechts und links verwendbar



Laufschuhschloss

mit zwei Schlüsseln, ausgeklinkt
Material: Zink

Art.-Nr.	Oberfläche	Ausführung
2116ZN1-G	mattverchromt	gleichschließend
2116ZN1-V	mattverchromt	verschiedenschließend

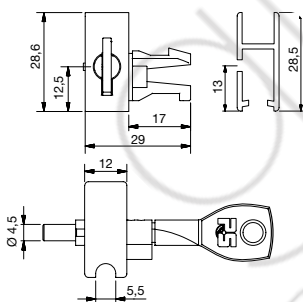

Bohrbild für Laufschuh
rechts und links verwendbar



Sicherheits-Laufschuhschloss

mit zwei Schlüsseln und Zylindersperrerr
Material: Kunststoff

Art.-Nr.	Oberfläche	Ausführung
2107KU6-G	mattverchromt	gleichschließend
2107KU6-V	mattverchromt	verschiedenschließend



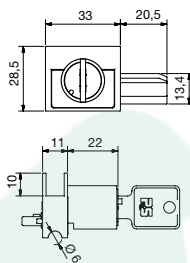
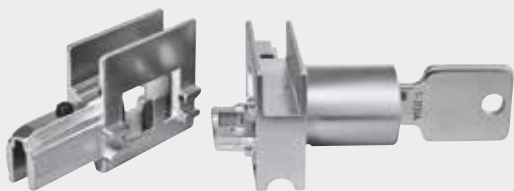

rechts und links verwendbar



Sicherheits-Laufschuhschloss

mit Schlüssel, ausgeklinkt

Material: Zink

Art.-Nr.	Oberfläche	Ausführung
2126ZN1-G	mattverchromt	gleichschließend
2126ZN1-V	mattverchromt	verschiedenschließend



Demontagestift

für Art.-Nr. 2126

Material: Stahl

Art.-Nr.	Oberfläche
2127ST8	verzinkt



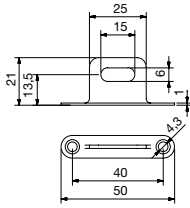

Aushängesicherung



Diebstahlsicherung
Material: Zink

Art.-Nr.	Oberfläche
2962ZN1	mattverchromt

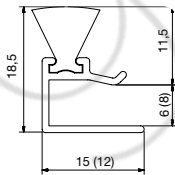

Staubschutzleiste



mit grauen Haarborsten
Material: Aluminium

Art.-Nr.		Oberfläche
2964E6EV1-5M	6 mm	naturfarbig
2965E6EV1-5M	8 mm	naturfarbig

SCHIEBETÜR BESCHLAG MODELL 2200 für Plattendicke 5-6 mm

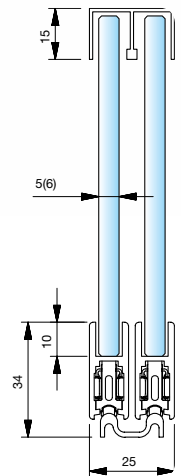
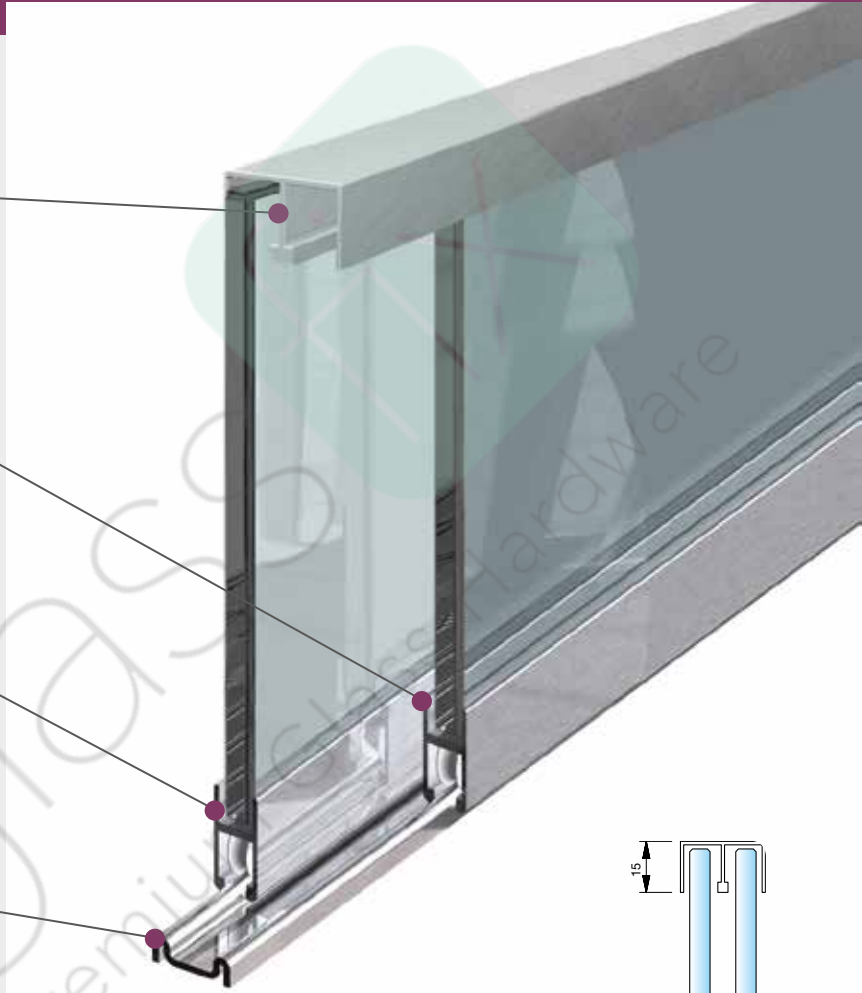
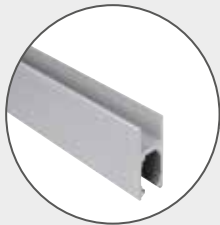
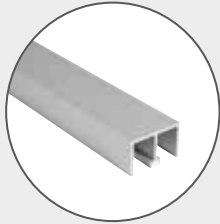

TECHNISCHE ANGABEN

Maximale Belastung pro Flügel

2 x 2103 ST8 = ca. 25 kg

4 x 2103 ST8 = ca. 50 kg

Berechnung des Glasmaßes ohne Klemmprofil:

Einbauhöhe - 29 mm = Glasmaß

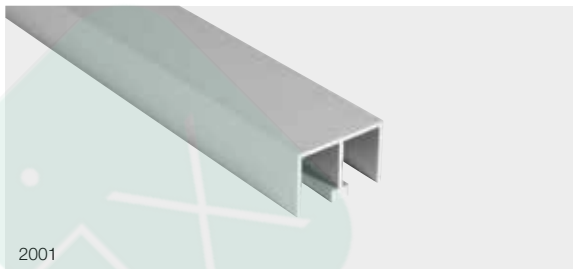
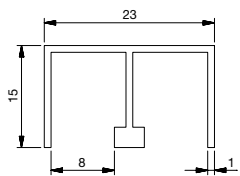

Obere Doppel-U-Führungsschiene

ungebohrt
Material: Aluminium, naturfarbig

Art.-Nr.		Ausführung
2001E6EV1-5M	5-6 mm	
2011E6EV1-5M	5-6 mm	samtiert, ruhig laufend

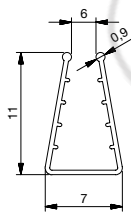

2756

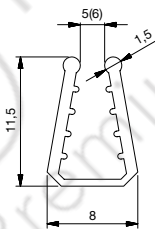

2758

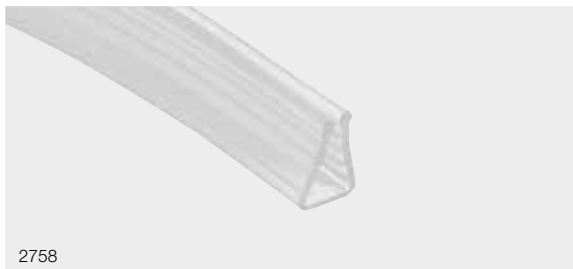

Klemmprofil

Material: Kunststoff

Art.-Nr.		Laufschuh	Oberfläche
2756KU0	6 mm	2222	transparent
2758KU0	5-6 mm	2222	transparent

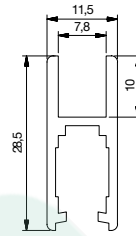

Laufschuh



mit Schutzfolie
Material: Aluminium

Art.-Nr.		Oberfläche
2222E6EV1-5M	5-6 mm	naturfarbig



Rolleneinsatz



Material: Stahl
mit kunststoffummantelter Stahlkugellager

Art.-Nr.	Oberfläche
2103ST8	verzinkt

Zubehör 2145 auf S. 10

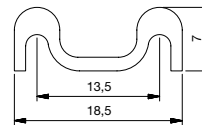

Untere Doppelaufschiene



mit Doppelklebeband
Material: Aluminium

Art.-Nr.	Oberfläche
2007E6EV1-5M	naturfarbig

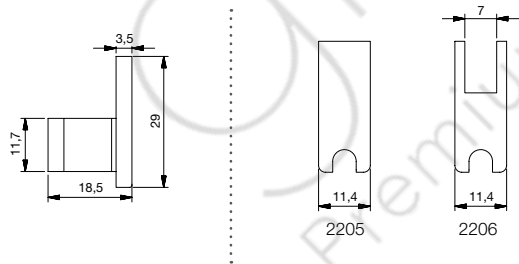
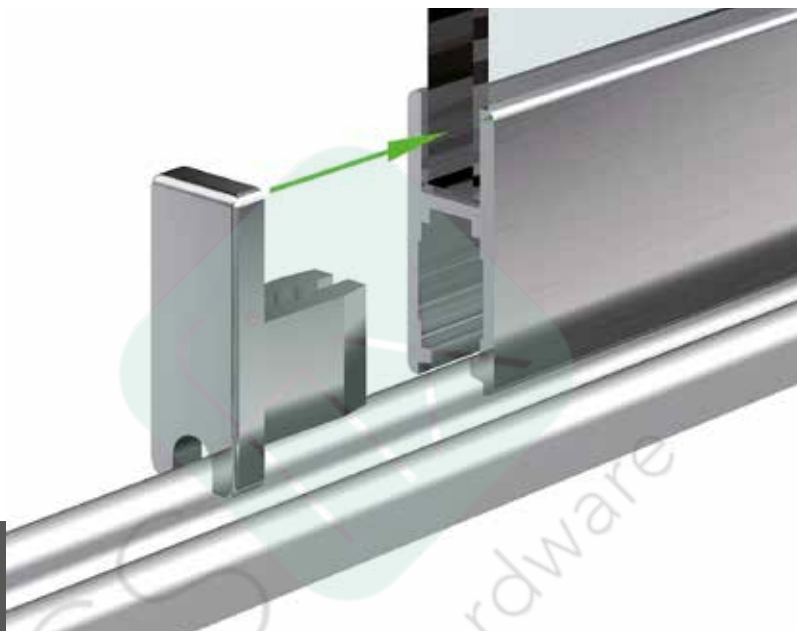

Endstück 

Material: Kunststoff

Art.-Nr.	Oberfläche	Ausführung
2205KU6	mattverchromt	
2206KU6	mattverchromt	ausgeklinkt



2959



2960

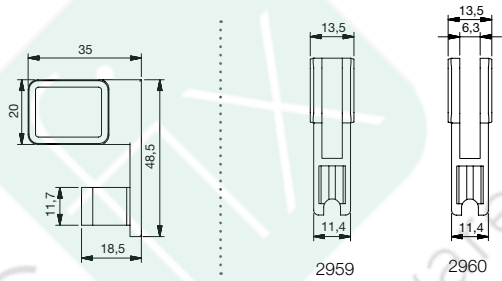

2959

2960

Laufschuhgriff



Material: Kunststoff
 Plattendicke: 5-6 mm

Art.-Nr.	Oberfläche	Ausführung
2959KU6	mattverchromt	
2960KU6	mattverchromt	ausgeklint



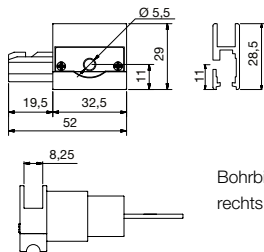

Bohrbild für Laufschuh
rechts und links verwendbar



Laufschuhschloss

mit zwei Schlüsseln, ausgeklinkt
Material: Zink

Art.-Nr.	Oberfläche	Ausführung
2116ZN1-G	mattverchromt	gleichschließend
2116ZN1-V	mattverchromt	verschiedenschließend

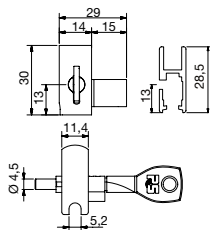

Bohrbild für Laufschuh
rechts und links verwendbar



Laufschuhschloss

mit zwei Schlüsseln
Material: Kunststoff

Art.-Nr.	Oberfläche	Ausführung
2905KU6-G	mattverchromt	gleichschließend
2905KU6-V	mattverchromt	verschiedenschließend

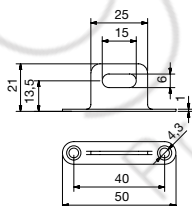

Aushängesicherung

Diebstahlsicherung
Material: Zink

Art.-Nr.	Oberfläche
2962ZN1	mattverchromt



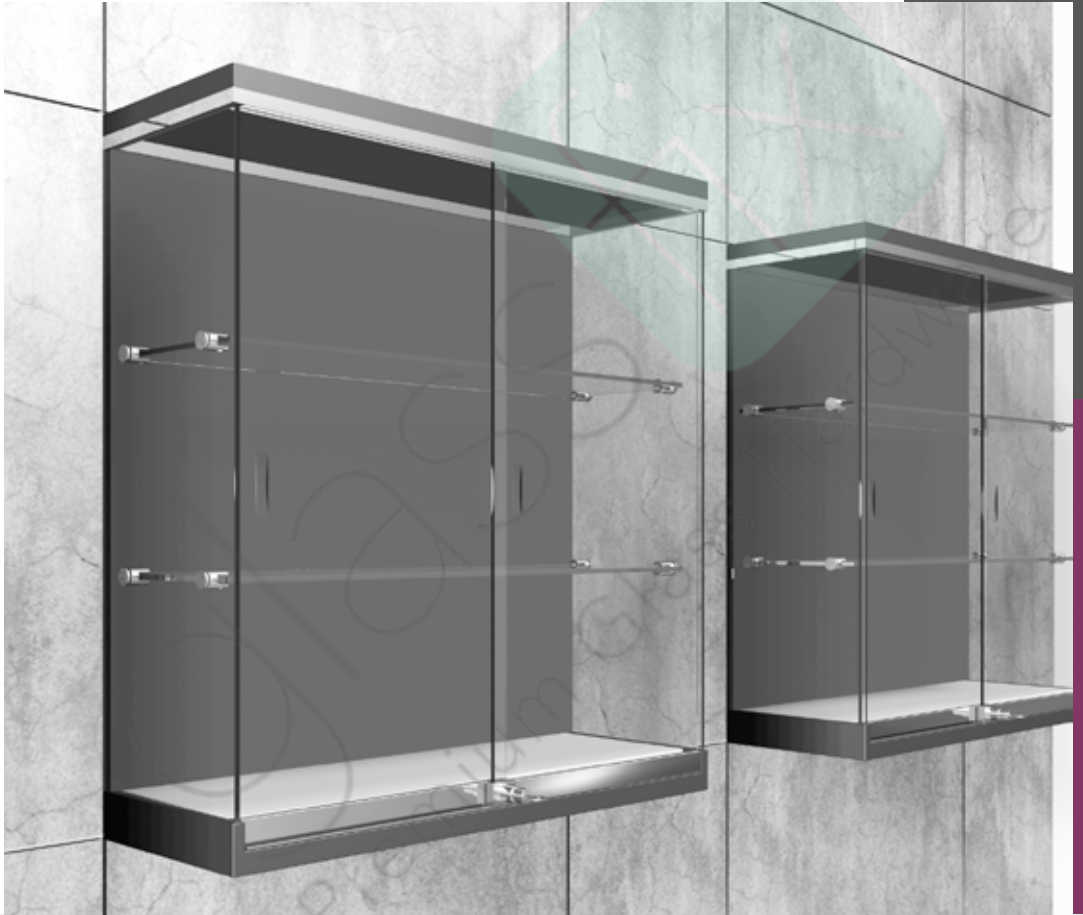

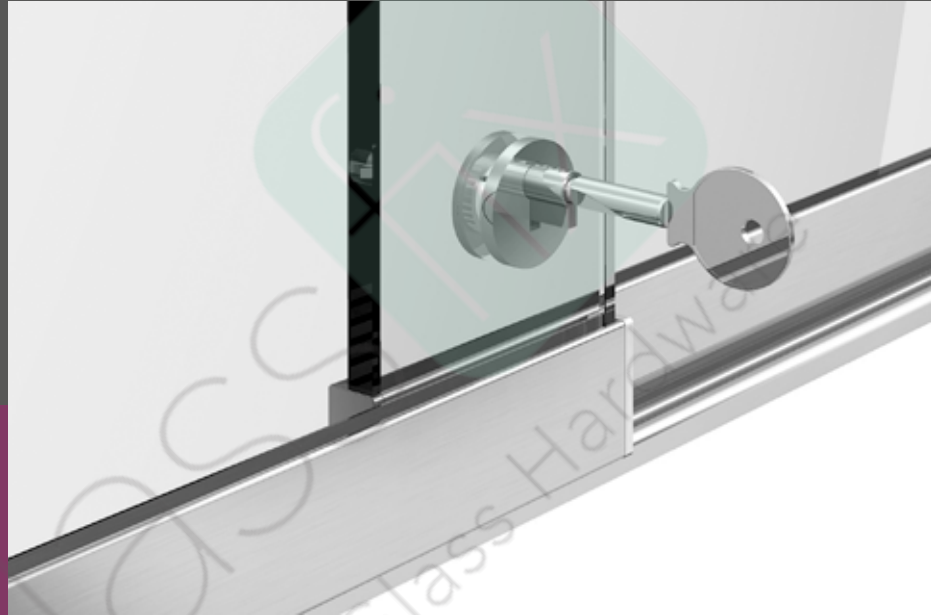

ZUBEHÖR



21 mm

2944

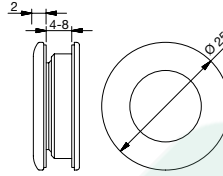

2944

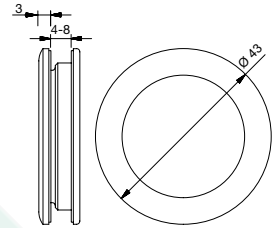

2950



37 mm

2950

Einlassgriff



zum Schrauben
Material: Aluminium

Art.-Nr.		Ø	Oberfläche
2944E3/1	4-8 mm	21 mm	mattverchromt
2944E3/5	4-8 mm	21 mm	glanzverchromt
2950E3/1	4-8 mm	37 mm	mattverchromt
2950E3/5	4-8 mm	37 mm	glanzverchromt

glas
Premium Glass Hardware

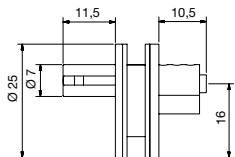

Glasschiebetürschloss

mit zwei Schlüsseln und Zylindersperrerr

Material: Kunststoff

Plattendicke: 6 mm

Art.-Nr.	∅	Ausführung	Oberfläche
2922KU6-G	16 mm	gleichschließend	mattverchromt
2922KU6-V	37 mm	verschiedenschließend	mattverchromt



16 mm

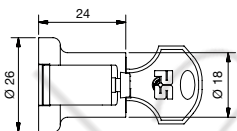

Glasschiebetürschloss

mit Zahnstange 125 mm lang zum Aufklemmen, mit zwei Schlüsseln

Material: Zink

Plattendicke: 2-8 mm

Art.-Nr.	Ausführung	Oberfläche
2930ZN3-G	gleichschließend	glanzverchromt
2930ZN3-V	verschiedenschließend	glanzverchromt



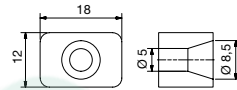

Gummipuffer



zum Anschrauben

Art.-Nr.

2970



Filzstreifen



10mm

selbstklebend

Anwendung: Klapperschutz etc.

Art.-Nr.

2972

Maße

13 mm x 1,5 mm

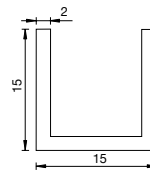

obere Einbahn-Führungsschiene,
passend zur unteren Einbahnlaufschiene
(2008)

U-Profil



5mm

Material: Aluminium

Maße: 15 x 15 x 5000 x 2 mm

Plattendicke ≤ 11 mm

Art.-Nr.	Ausführung	Oberfläche
5015		Aluminium
5016	samtiert, ruhig laufend	Aluminium

