

# Price list 2018

Glass fittings  
and systems

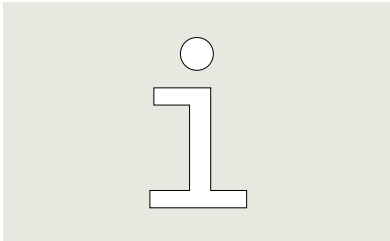





**04 General Information**

Product division /	4
Explanation of articles numbers	5 - 6
Finishes / Delivery times	7 - 9
Application possibilities	10 - 13
Index of content	



**15 Manual sliding door systems**



**182 Manual single action door systems**



**272 Manual double action door systems**



**284 Fittings for toughened glass assemblies**



**393 Levers, handle bars and pull grips**



**406 UNIQUIN**

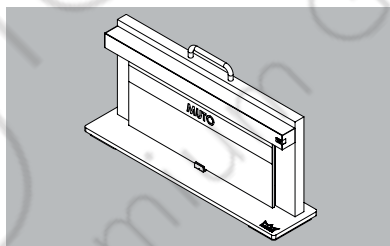

**408 Samples**



**410 Color overview**

## Product Division

Our product portfolio is divided according to the function of the products:

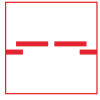

Manual sliding door systems  
(SLIDING)



Manual double action door systems  
(DOUBLE ACTION)



Manual single action door systems  
(SINGLE ACTION)



Fittings for toughened glass assemblies  
(TOUGHENED GLASS ASSEMBLIES)

## Explanation of article numbers

On the basis of OFFICE Junior, profile cylinder, left hand, finish Alu silver EV1

Complete article no: 8.11.200.101.99

8	-	11	-	200	-	101	-	99
Plant DORMA-Glas		Fitting group		Article definition		finish		Salable article

Short version in this price list

**11.200**

The indication for "Plant DORMA-Glas" and "Salable article" are always fix components of the complete article no.  
(exception CS 80 MAGNEO, OGRO)

## Pictographs / Pictures

The pictographs in this price list have been included for guidance only.  
They are not true to scale and do not constitute a binding description of the exact application of the products!

**Subject to change without notice.**

## Technical Support / Application technology

In case of any questions or need for assistance with creating complete solutions our department for technical support will be pleased help you.

Your benefits:

- Technical advice for Interior Glass Products
- Support for creating complete solutions
- Assistance in terms of installation issues

# Finishes

## Finish codes

The finish codes at the top of the price columns inform you about the materials, colors and finishes available for the products. They can differ with regards to the various products, therefore only those finishes indicated with a price for the respective product are available.

Please contact us if your required finish is not shown there. We will endeavour to help you.

Base parts, various material	
000	Base parts

Aluminium, mill finish, anodized, chromed	
100	AL mill finish (Aluminium R 600)
101	AL silver EV1 anodized (similar Eloxal I EV1 / Eloxal II C 0)
103	AL silver brilliant anodized
105	AL brass colored EV3 anodized (similar Eloxal I EV 3)
106	AL brass brilliant anodized
107	AL similar satin stainless steel anodized
108	AL dark bronze DB 14 anodized (similar Eloxal I DB 14/MC 1003 / Eloxal II C 34)
113	AL similar satin stainless steel anodized (for profile material) (similar Eloxal II C 31)
114	AL EV1-Deco anodized (compatible with finish 150)
122	AL polished chromed (not available as special anodized finish)
126	AL satin stainless steel look (Niro N 700 ST)
127	AL polished stainless steel look (Niro N 700 HG)
150	AL silver anodized (Silver N 600 ST) (compatible with finish 114)
157	AL niro anodized (Niro N 700)
199	AL special color anodized

Aluminium, liquid coated	
299	AL special color liquid coated

Aluminium, powder coated	
300	AL traffic white powder coated
350	AL white powder coated (White P 100 SG)
382	AL graphite scratch resistant powder coated (Graphite P 182 SR)
399	AL special color powder coated (Standard powder according to RAL)

## Finish sample sets

For finish sample sets in basic material aluminium, brass and stainless steel please see page 408

## Note

Special anodized colors (199) as well as special colors (299) and (399) on request. Please provide color sample, if available.

Finish differences through production cannot be totally excluded.

Brass, various finish treatments	
500	Brass satin chromed
501	Brass polished chromed
502	Brass polished varnished
503	Brass polished
507	Brass similar satin stainless steel

Stainless steel, various finish treatments	
700	Satin stainless steel (Niro S 700 ST)
701	Polished stainless steel (Niro S 700 HG)
750	Satin stainless steel (Niro S 700 ST) (for MUNDUS)
751	Polished stainless steel (Niro S 700 HG) (for MUNDUS)

Plastic, various finish treatments	
803	Plastic black
804	Plastic satin chromed
805	Plastic traffic white

Glass, glass reverse side varnished, top side high gloss glass surface	
810	Glass white (Glass G 810 HG)
880	Glass black (Glass G 880 HG)

## Delivery periods

The delivery periods pertaining to our products depend on the system-related preparation times and the transit times relevant to the destination concerned. Within 24 hours following order receipt you will receive from us a corresponding confirmation of order receipt or, in the case of standard product orders, a normal order confirmation.

The standard times given in this price list are for guidance only. The precise order-specific delivery periods are shown in the order confirmation, which will be sent to you once all the details of the order have been clarified. The cited dates will take into account not only the time necessary for transportation/shipment but also any specific requirements previously agreed such as consignment groupage, collective delivery and designated departure dates.

## Preparation times

This is defined as the number of days from the date of order confirmation until the products are ready for dispatch at the factory in Bad Salzuflen.

The likely preparation times are indicated by the color coding of the price backgrounds.

**2 5 10 15 20 25**

The color strip (at the bottom of price list pages) numeralizes the preparation time in days.

They relate to order quantities per item of max.

25 pieces for individual fittings/sets

120 m for profiles

The preparation times for larger quantities respectively for projects, customised solutions and modifications may differ. We will be glad to inform you on request of the delivery times that then apply. Subsequent order changes will result in the preparation and delivery times being recalculated and reconfirmed.

## Transit times

This is defined as the number of days it takes to transport the items door-to-door from Bad Salzuflen to the delivery address.

Some transit times to various countries of destination are indicated in the table below. Please note that the number of days indicated is subject to variations arising from designated departure days.

We will gladly quote transit times for countries not listed.

Country (Delivery destination)	Departure days (from Bad Salzuflen)	Transit time up to (Working days)
Austria	daily	3
Belgium	daily	2
Bosnia	Thu	8
Bulgaria	Thu	5
Croatia	Tue + Fri	4
Czech Rublic	daily	4
Denmark	Tue, Wed, Fri	2
Estonia	Tue + Fri	4
Finland	Tue + Fri	5
France	daily	4
Germany	daily	2
Great Britain	Tue + Fri	3
Greece	Fri	5
Hungary	Tue, Wed, Thu, Fri	4
Ireland	Tue + Fri	5
Italy	Tue + Fri	4
Latvia	Tue + Fri	5
Lithuania	Tue + Fri	5
Luxembourg	daily	2
Netherlands	daily	2
Norway	Tue + Fri	4
Poland	daily	3
Portugal	Thu	5
Romania	Tue + Fri	5
Serbia	Tue, Wed, Fri	5
Slovakia	Tue + Fri	4
Slovenia	Tue + Fri	3
Spain	Tue + Fri	5
Sweden	daily	4
Switzerland	daily	3
Turkey	Thu	7

**All prices are gross prices exclusive freight and packing!**  
Please consider our general terms and conditions shown on [www.dorma.com](http://www.dorma.com)

# Sliding door systems

	MUTO Comfort M 50	MUTO Comfort L 80	MUTO Premium XL 80/150	MUTO Premium Self-Closing 120	RS 120	MANET Compact	MANET Concept	RSP 80	CS 80 MAGNEO
<b>Standard applications</b>									
Glass door for wall installation	●	●	●	●	●	●	●	●	●
Glass door for wall installation, bridging over door jamb						●	●	○	●
Glass door for wall installation, Synchro		●	●		●				
Glass door for ceiling installation	●	●	●	●	●		●		○
Glass door for ceiling installation, Synchro		●	●		●				
Glass door with glass sidelights		●	●	●	●		●		●
Glass door with glass sidelights, Synchro		●	●		●				
Glass door with glass overhead lights and sidelights		●	●	●		●	●		●
Timber door for wall installation		●	●	●	●		●	●	●
Timber door for ceiling installation		●	●	●	●		●		○
Timber door with glass sidelight/s		●	●	●	●		●		
Timber door with glass overhead light and sidelight/s		●	●	●			●		●
<b>Special applications individual configuration, customisation on-site (advisory service necessary)</b>									
Glass door for wall installation, double panel assemblies, standard	●	●	●	●	●	●	●	●	●
Glass door for wall installation, double panel assemblies, bridging over door jamb						●	●	●	●
Glass door for wall installation, curved system							●		
Glass door for ceiling installation, curved system							●		
Glass door with glass sidelights, double-leaf		●	●	●	●		●		●
Glass door with glass overhead lights and sidelights, Synchro		●	○						
Glass door with glass overpanels & glass sidelights, double-leaf		●	●	●	●	●	●		●
Glass door with glass overpanels & glass sidelights, curved system							●		
Free-standing glass assemblies							●		
Timber door for wall installation, Synchro		●	●		●				

For further information such as max. door measurements please consider our technical brochures.

# Single- and double action door systems

	STUDIO Rondo	STUDIO Classic	STUDIO Gala 2.0	STUDIO Arcos	STUDIO Medio	OFFICE Junior	OFFICE Classic	OFFICE Arcos	OFFICE Arcos	TENSOR	VISUR	RP
<b>Applications</b>												
For assemblies in open-air areas												○
For assemblies in interior (single- and double-leaf)	●	●	○	●	●	●	●	●	●	●	●	●
For standard toughened glass assembly types (with side lights and / or over panels)										●	○	○
Usable for objects						●	●	●	●	●		●
For double action doors										●	●	●
For single action doors	●	●	●	●	●	●	●	●	●	●	●	●
<b>Material / Finishes</b>												
Aluminum (according to RAL / Anodised coating)	●	●	●	●	●	●	●	●	●	●	●	●
Brass	●			○		●						
Stainless steel						○						
Special anodised coating / Special color	●	●		●	●	●	●	●	●			●

**Caption**

- suitable / available
- of limited suitability / only available for selected variants

For further information such as max. door measurements please consider our technical brochures.



# Toughened glass assemblies

	MUNDUS Comfort	MUNDUS Premium	UNIVERSAL	UNIVERSAL Arcos	BEYOND	Patchfitting EA	Door rails TP	Door rails TA	MANET Compact	MANET Concept	Wall connecting profile	MR22 / MR28	Locks SG
<b>Applications</b>													
For assemblies in open-air areas	●	●	●	●		●	●	●		●	○		○
For assemblies in interior	●	●	●	●	●	●	●	●	●	●	●	●	●
For standard toughened glass assembly types	●	●	●	●	●	●	●	●	●	●	●		●
For individual planed systems (angled systems, reinforcement)	○	○	●	○	●	●	●	●	○	●	●		●
For double action doors	●	●	●	●	●		●		●	●	●		○
For single action doors	●	●	●	●	●	●	●	●	●	●	●		○
<b>Material / Finishes</b>													
Aluminum (according to RAL / Anodised coating)	●	●	●	●	●	●	●	●				●	●
Brass			●			●					●		
Stainless steel	●	●	●	●		●	●	●	●	●	●		○
Special anodised coating / Special color		●	●	●		●	●	●			●		●

## Caption

- suitable / available
- of limited suitability / only available for selected variants

For further information such as max. door measurements please consider our technical brochures.

# Index of content

## Manual Sliding door systems

<b>15</b>	<b>MUTO Comfort M 50</b>
18	Glass door for installation at wall
20	Glass door for installation at ceiling
<b>23</b>	<b>MUTO Comfort L 80</b>
26	Glass door single-leaf, installation at wall
28	Glass door double-leaf, installation at wall
30	Glass door single-leaf, installation at ceiling
32	Glass door double-leaf installation at ceiling
34	Glass door single-leaf with sidelight/s for installation at ceiling
36	Glass door double-leaf with sidelights for installation at ceiling
38	Glass door single-leaf, with glass overpanel and glass sidelights
40	Glass door double-leaf, with glass overpanel and glass sidelights
42	Timber door single-leaf, installation at wall
44	Timber door double-leaf, installation at wall
46	Timber door single-leaf, installation at ceiling
48	Timber door double-leaf, installation at ceiling
50	Timber door single-leaf with sidelight/s for installation at ceiling
52	Timber door double-leaf with sidelights for installation at ceiling
54	Timber door single-leaf, with glass overpanel and glass sidelights
56	Timber door double-leaf, with glass overpanel and glass sidelights
<b>59</b>	<b>MUTO Premium XL 80/150</b>
62	Glass door single-leaf, installation at wall
64	Glass door double-leaf, installation at wall
66	Glass door single-leaf, installation at ceiling
68	Glass door double-leaf installation at ceiling
70	Glass door single-leaf with sidelight/s for installation at ceiling
72	Glass door double-leaf with sidelights for installation at ceiling
74	Glass door single-leaf, with glass overpanel and glass sidelights
76	Glass door double-leaf, with glass overpanel and glass sidelights
78	Timber door single-leaf, installation at wall
80	Timber door double-leaf, installation at wall
82	Timber door single-leaf, installation at ceiling
84	Timber door double-leaf, installation at ceiling
86	Timber door single-leaf with sidelight/s for installation at ceiling
88	Timber door double-leaf with sidelights for installation at ceiling
90	Timber door single-leaf, with glass overpanel and glass sidelights
92	Timber door double-leaf, with glass overpanel and glass sidelights

<b>95</b>	<b>MUTO Premium Self-Closing 120</b>
98	Glass door single-leaf, installation at wall
100	Glass door single-leaf, installation at ceiling
102	Glass door single-leaf with sidelight/s for installation at ceiling
104	Glass door single-leaf, with glass overpanel and glass sidelights
106	Timber door single-leaf, installation at wall
108	Timber door single-leaf, installation at ceiling
110	Timber door single-leaf with sidelight/s for installation at ceiling
112	Timber door single-leaf, with glass overpanel and glass sidelights
	<b>MUTO Premium Telescopic 80</b>
118, 122	Glass door for installation at wall
119, 120, 123, 124	Glass door for installation at ceiling / Glass door for installation at ceiling with glass sidelight
121, 125	Glass door for installation at glass
126	Timber door for installation at wall
127, 128	Timber door for installation at ceiling / Glass door for installation at ceiling with glass sidelight
129	Timber door for installation at glass
<b>115</b>	<b>Accessories for the MUTO range</b>
130	MUTO integrated locking mechanism/status indicator
131	MUTO LSG Accessories
<b>133</b>	<b>RS 120</b>
136	Glass door for installation at wall or ceiling
138	Glass door for installation at wall or ceiling, Synchro
140	Glass door with sidelight/s
142	Glass door with sidelight/s, Synchro
144	Timber door for installation at wall or ceiling
<b>145</b>	<b>MANET Compact/Concept, Sliding</b>
148	Glass door for installation at wall
150	Glass door with glass overpanels & glass sidelights
154	Accessories, Single-point fixings, Connectors
<b>165</b>	<b>RSP 80</b>
167	Glass door for installation at wall
168	Timber door for installation at wall
<b>170</b>	<b>CS 80 MAGNEO (automatic power unit)</b>
172	Glass door for installation at wall/in wall installation
174	Glass door for glass overpanels & glass sidelights
175	Single components, power units, doorkits, motion sensor
	<b>General accessories for "Sliding door systems"</b>
360	DORMA SG - Centre and corner locks, strike boxes
369	U-profiles

## Manual single action door systems

### STUDIO

182	STUDIO Rondo
190	STUDIO Classic
196	STUDIO Gala 2.0
202	STUDIO ARCOS
210	STUDIO Medio

### OFFICE

214	OFFICE Junior
220	OFFICE Classic
226	OFFICE Arcos

### 232 Special hinges

### 236 PORTEO

### ALEXA door frames

240	AT 23 / AT 23E
244	AT 44
250	AT 50 with AT 44 / AT 50 with MR 28
256	Order form

### General accessories for "Single action door systems"

258	Frame pivots
260	Frame pockets, push-on sleeves, strike plates
262	Door rails for interior doors
266	Floor bearings, profile cylinder, door bolt, door snapper, floor sockets
270	Door closer, Door closer accessories

## Manual double action door systems

### 272 TENSOR

### 276 VISUR

### 280 RP-Frame profile with transom door closer

### General accessories for "Double action door systems"

376	Centre and corner locks, strike boxes
-----	---------------------------------------

## Fittings for toughened glass assemblies

284	<b>MUNDUS Comfort</b>
294	<b>MUNDUS Premium</b>
304	<b>UNIVERSAL</b>
316	<b>UNIVERSAL Arcos</b>
322	<b>UNIVERSAL light</b>
326	<b>BEYOND</b>
330	<b>EA-Patch fittings for single action doors</b>
338	<b>TP / TA Door rails</b>
354	<b>MANET Compact/Concept, single action doors</b>
366	<b>Wall connecting profiles</b>
372	<b>Frame systems MR 22 / MR 28</b>
376	<b>DORMA SG Centre and corner locks, strike boxes</b>
	<b>General accessories for "Toughened glass assemblies"</b>
387	Clamping fitting, U-profile
388	Pivot bearing, floor bearing, strike plates, floor sockets
391	Locking units for toughened glass assemblies

## Levers, handle bars and recessed pull grips

394	<b>Levers with follower</b>
398	<b>Levers with roses</b>
402	<b>Handle bars</b>
404	<b>Pull grips and door knobs</b>

## Access and room system

406	<b>UNIQUIN</b>
-----	----------------

## Samples

408	<b>Mobile presentation module and color samples</b>
409	<b>Desk samples</b>
410	<b>Register of colors and availability</b>

## Product register of example pictures

412	<b>Product register of example pictures</b>
418	<b>Notification for returns</b>



# MUTO Comfort M 50



Technical data	
Glass	TSG
Glass thickness	8, 10 mm
Max. door weight	50 kg
Application	single-leaf
Material	Aluminium
Finishes	Anodized- and RAL-Colors (coated)
Kind of installation	Wall and ceiling
Specials	DORMOTION (optionally retrofittable) Tested acc. DIN EN 1527 Height readjustable without dismantling +4/-2 mm

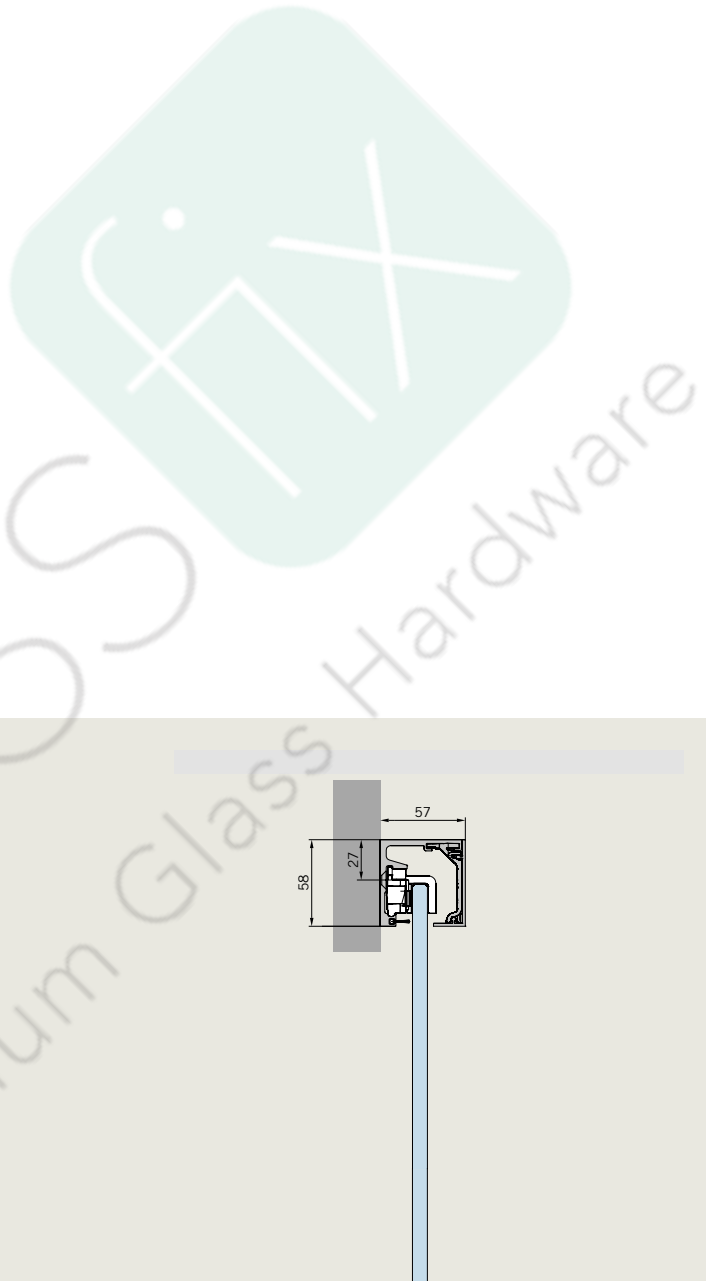

Example view for MUTO Comfort M 50 installation at wall

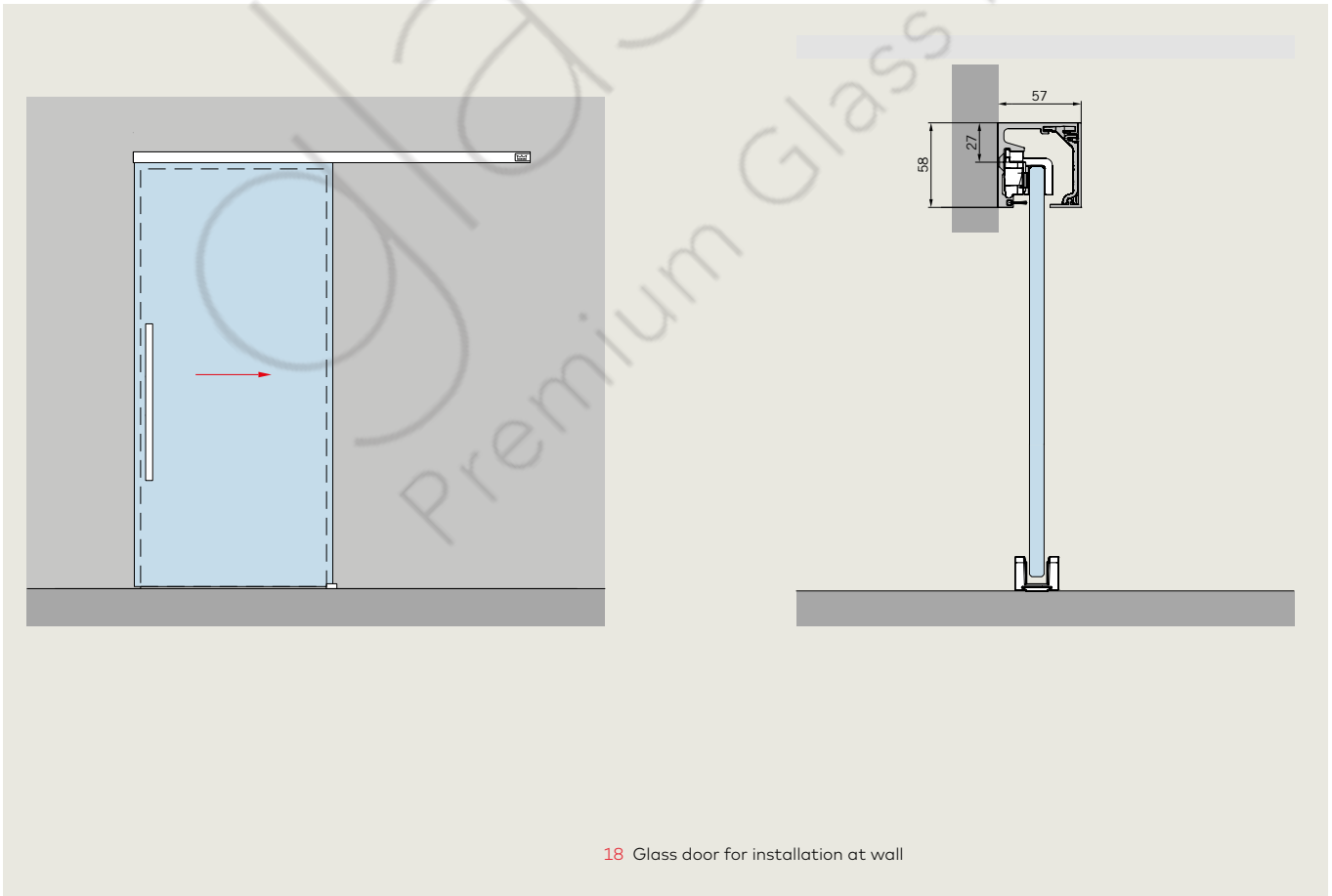

18 Glass door for installation at wall



Example view for MUTO Comfort M 50 installation at ceiling

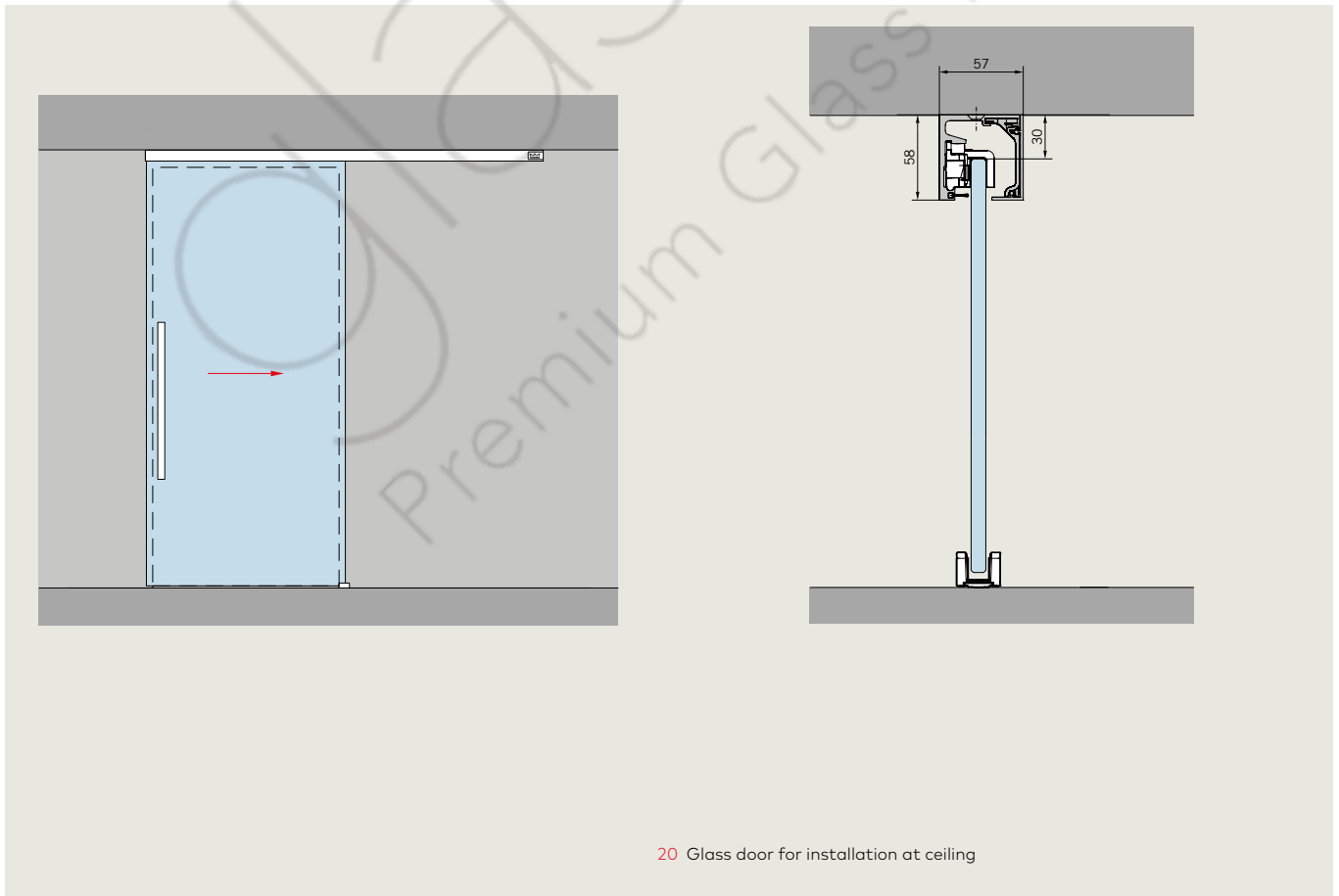

20 Glass door for installation at ceiling

Glass door (8 – 10 mm) for installation at wall

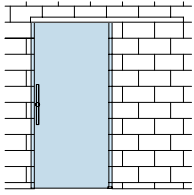

AL silver anod (150)	AL niro anod (157)	AL white p-coat (350)	AL special color anod (199)	AL special color p-coat (399)
				*

Art. No.	Description	€/Piece	€/Piece	€/Piece	€/Piece	€/Piece
----------	-------------	---------	---------	---------	---------	---------

Complete sets (optional with DORMOTION)

Defined lengths

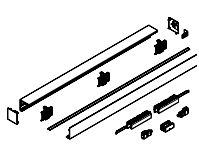

<b>36.100</b>	<b>MUTO Comfort M 50 for 950 mm panel width</b> consisting of: 1 track profile 1880 mm 1 cover profile 1880 mm 2 clamp carriers (for 8 – 13,5 mm glass thickness) with anti-jump mechanism 2 endstops with safety catch and anti jump device 1 floor guide 2 end caps incl. view protection brushes 1880 mm	206,00	229,00	206,00	276,00	276,00
---------------	---	--------	--------	--------	--------	--------

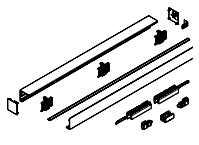

<b>36.101</b>	<b>MUTO Comfort M 50 for 1200 mm panel width</b> consisting of: 1 track profile 2380 mm 1 cover profile 2380 mm 2 clamp carriers (for 8 – 13,5 mm glass thickness) with anti-jump mechanism 2 endstops with safety catch and anti jump device 1 floor guide 2 end caps incl. view protection brushes 2380 mm	252,00	287,00	252,00	332,00	332,00
---------------	--	--------	--------	--------	--------	--------

Individual lengths

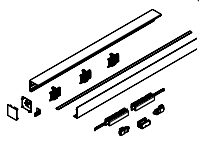

<b>36.106</b>	<b>MUTO Comfort M 50 for max. 1300 mm panel width</b> consisting of: 1 track profile max. 2600 mm 1 cover profile max. 2600 mm 2 clamp carriers (for 8 – 13,5 mm glass thickness) with anti-jump mechanism 2 endstops with safety catch and anti jump device 1 floor guide 2 end caps incl. view protection brushes max. 2600 mm	Basic 1880 mm Surcharge per mm Max. 2600 mm	206,00 0,20	229,00 0,20	206,00 0,20	276,00 0,20	276,00 0,20
---------------	--	---	----------------	----------------	----------------	----------------	----------------

\* With assemblies in special color (399) the end caps will be delivered in plastic anthracite-grey solid-colored.

## Glass door (8 – 10 mm) for installation at wall

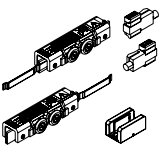
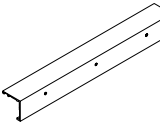
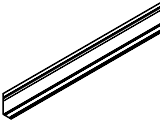
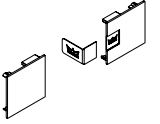
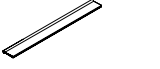
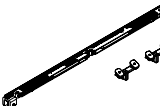
Art. No.	Description	Color options					
		Base parts (000)	AL silver anod (150)	AL niro anod (157)	AL white p-coat (350)	AL special color anod (199)	AL special color p-coat (399)
		€/Piece	€/Piece	€/Piece	€/Piece	€/Piece	€/Piece
<b>Single components</b>							
	<b>36.150 MUTO Comfort M 50 accessories set</b> consisting of: 2 clamp carriers 2 endstops 1 floor guide	<b>138,00</b>	<b>138,00</b>				
	<b>MUTO Comfort M 50 track profile</b> for installation at wall stock length 6000 mm	<b>182,00</b>	<b>208,00</b>	<b>182,00</b>	<b>250,00</b>	<b>250,00</b>	
	<b>36.108</b>	€/m	€/m	€/m	€/m	€/m	
	<b>36.111</b> in fixed length	<b>37,50</b>	<b>43,50</b>	<b>37,50</b>	<b>52,00</b>	<b>52,00</b>	
	<b>MUTO Comfort M 50 cover profile</b> stock length 6000 mm	<b>82,50</b>	<b>95,00</b>	<b>82,50</b>	<b>114,00</b>	<b>114,00</b>	
	<b>36.110</b>	€/m	€/m	€/m	€/m	€/m	
	<b>36.113</b> in fixed length	<b>17,00</b>	<b>19,50</b>	<b>17,00</b>	<b>23,50</b>	<b>23,50</b>	
	<b>36.152 MUTO Comfort M 50 set end caps</b> installation at wall and ceiling	<b>11,50</b>	<b>11,50</b>	<b>11,50</b>			<b>11,50</b>
	<b>36.265 MUTO set of view protection brushes for Comfort M, L and Premium XL</b> consisting of: 1 view protection brush 8–10 mm glass thickness 1 view protection brush 12–13.5 mm glass thickness	€/m	<b>9,80</b>				
<b>Single components (optionally retrofittable)</b>							
	<b>36.153 MUTO Comfort M 50 DORMOTION unit</b> for max. 50 kg, incl. starter min. panel width 905 mm max. panel width 1300 mm	<b>68,50</b>					

\* With assemblies in special color (399) the end caps will be delivered in plastic anthracite-grey solid-colored.

Glass door (8, 10 mm) for installation at ceiling

Sliding

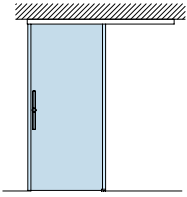

AL silver anod (150)	AL niro anod (157)	AL white p-coat (350)	AL special color anod (199)	AL special color p-coat (399)
				*

Art. No.	Description	€/Piece	€/Piece	€/Piece	€/Piece	€/Piece
----------	-------------	---------	---------	---------	---------	---------

Complete sets (optional with DORMOTION)

Defined lengths

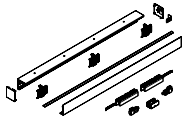

**36.103 MUTO Comfort M 50 for 950 mm panel width**  
 consisting of:  
 1 track profile 1880 mm  
 1 cover profile 1880 mm  
 2 clamp carriers (for 8 - 13.5 mm glass thickness) with anti-jump mechanism  
 2 endstops with safety catch and anti jump device  
 1 floor guide  
 2 end caps  
 incl. view protection brushes 1880 mm

206,00	229,00	206,00	276,00	276,00
--------	--------	--------	--------	--------

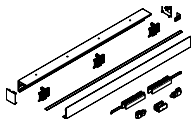

**36.104 MUTO Comfort M 50 for 1200 mm panel width**  
 consisting of:  
 1 track profile 2380 mm  
 1 cover profile 2380 mm  
 2 clamp carriers (for 8 - 13.5 mm glass thickness) with anti-jump mechanism  
 2 endstops with safety catch and anti jump device  
 1 floor guide  
 2 end caps  
 incl. view protection brushes 2380 mm

264,00	287,00	264,00	332,00	332,00
--------	--------	--------	--------	--------

Individual lengths

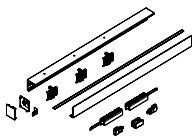



**36.107 MUTO Comfort M 50 for max. 1300 mm panel width**  
 consisting of:  
 1 track profile max. 2600 mm  
 1 cover profile max. 2600 mm  
 2 clamp carriers (for 8 - 13.5 mm glass thickness) with anti-jump mechanism  
 2 endstops with safety catch and anti jump device  
 1 floor guide  
 2 end caps  
 incl. view protection brushes max. 2600 mm

Basic 1880 mm  
 Surcharge per mm  
 Max. 2600 mm

206,00	229,00	206,00	276,00	276,00
0,20	0,20	0,20	0,20	0,20

\* With assemblies in special color (399) the end caps will be delivered in plastic anthracite-grey solid-colored.

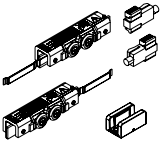
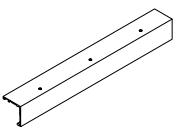
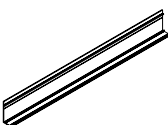
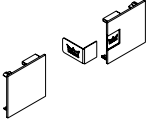
## Glass door (8, 10 mm) for installation at ceiling

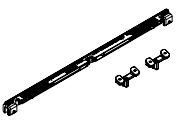
Art. No.	Description	Base parts (000)	AL silver anod (150)	AL niro anod (157)	AL white p-coat (350)	AL special color anod (199)	AL special color p-coat (399)
		€/Piece	€/Piece	€/Piece	€/Piece	€/Piece	€/Piece
<b>Single components</b>							
	<b>36.150 MUTO Comfort M 50 accessories set</b> consisting of: 2 clamp carriers 2 endstops 1 floor guide		<b>138,00</b>	<b>138,00</b>			
	<b>MUTO Comfort M 50 track profile</b> for installation at ceiling stock length 6000 mm		<b>182,00</b>	<b>208,00</b>	<b>182,00</b>	<b>250,00</b>	<b>250,00</b>
	<b>36.109</b>	€/m	€/m	€/m	€/m	€/m	€/m
	<b>36.112</b> in fixed length		<b>37,50</b>	<b>43,50</b>	<b>37,50</b>	<b>52,00</b>	<b>52,00</b>
	<b>MUTO Comfort M 50 cover profile</b> stock length 6000 mm		<b>82,50</b>	<b>95,00</b>	<b>82,50</b>	<b>114,00</b>	<b>114,00</b>
	<b>36.110</b>	€/m	€/m	€/m	€/m	€/m	€/m
	<b>36.113</b> in fixed length		<b>17,00</b>	<b>19,50</b>	<b>17,00</b>	<b>23,50</b>	<b>23,50</b>
	<b>36.152 MUTO Comfort M 50 set end caps</b> installation at wall and ceiling		<b>11,50</b>	<b>11,50</b>	<b>11,50</b>		<b>11,50</b>
	<b>36.265 MUTO set of view protection brushes for Comfort M, L and Premium XL</b> consisting of: 1 view protection brush 8-10 mm glass thickness 1 view protection brush 12-13.5 mm glass thickness	€/m	<b>9,80</b>				
<b>Single components (optionally retrofittable)</b>							
	<b>36.153 MUTO Comfort M 50 DORMOTION unit</b> for max. 50 kg, incl. starter min. panel width 905 mm max. panel width 1300 mm		<b>68,50</b>				

\* With assemblies in special color (399) the end caps will be delivered in plastic anthracite-grey solid-colored.

Notes

Sliding



# MUTO Comfort L 80



Technical data	
Glass	TSG, LSG (2 x TSG)
Glass thickness	8-13,5 mm
Max. door weight	80 kg
Application	single-leaf, double-leaf (glass or timberleaves), glass sidelights, at glass
Material	Aluminium
Finishes	Anodized- and RAL-Colors (coated)
Kind of installation	Wall, ceiling and at glass
Specials	DORMOTION, integrated locking mechanism and status indicator are optionally retrofittable For double leaf assemblies Synchro is optionally retrofittable Tested acc. DIN EN 1527 Height readjustable without dismantling +5/-3 mm

Example view for MUTO Comfort L 80 installation at wall

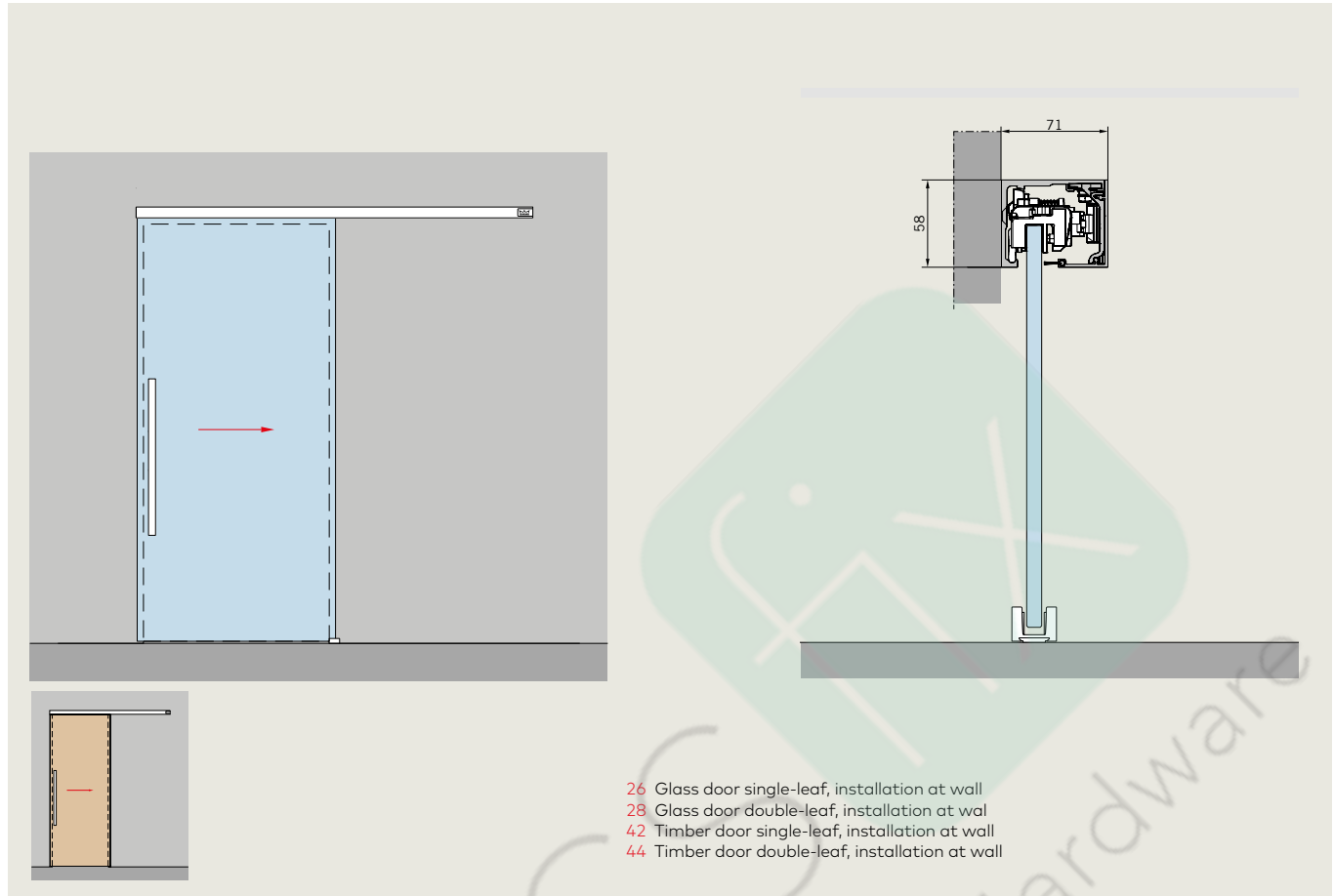

Example view for MUTO Comfort L 80 installation at ceiling

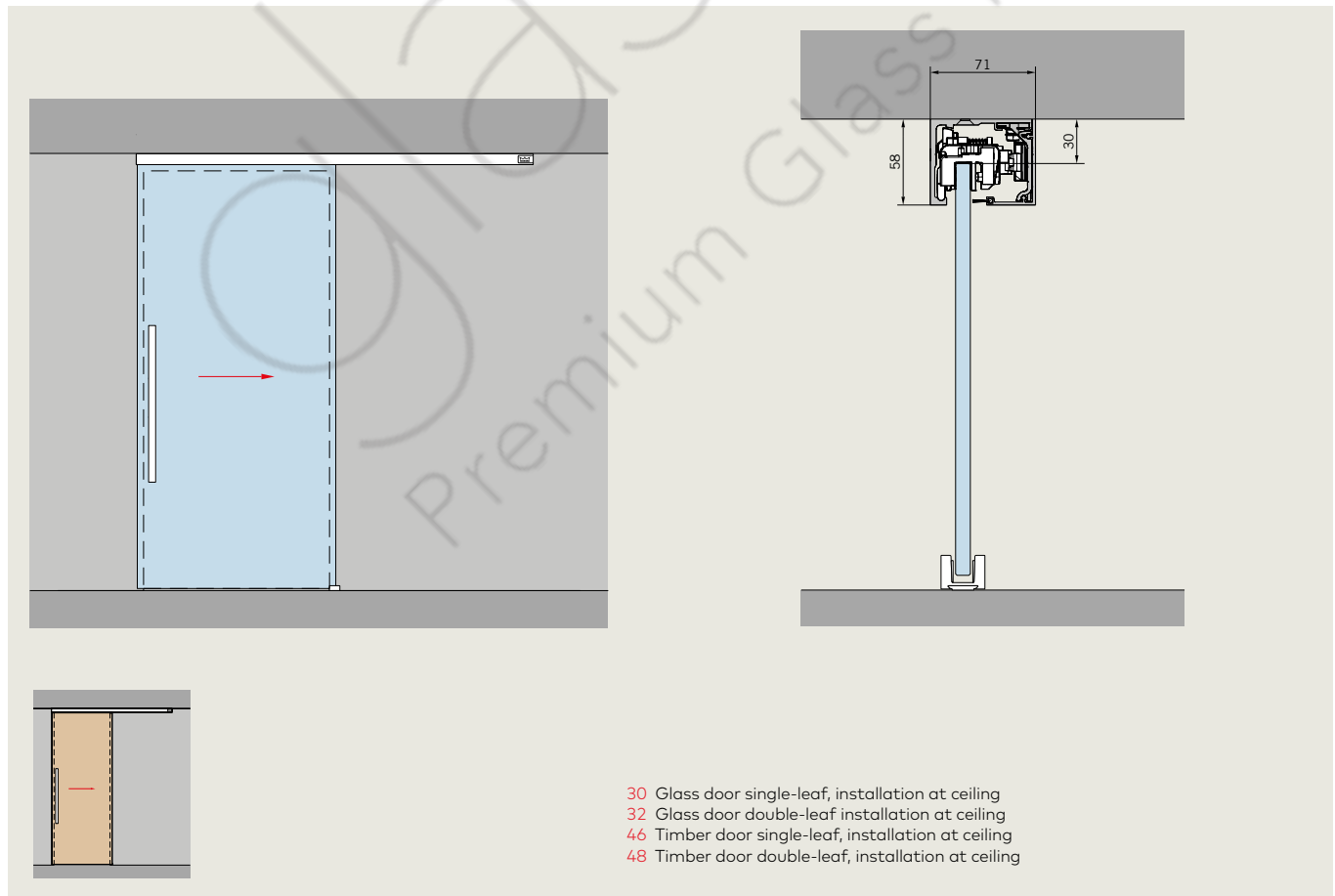



Example view for MUTO Comfort L 80 with glass sidelight/s

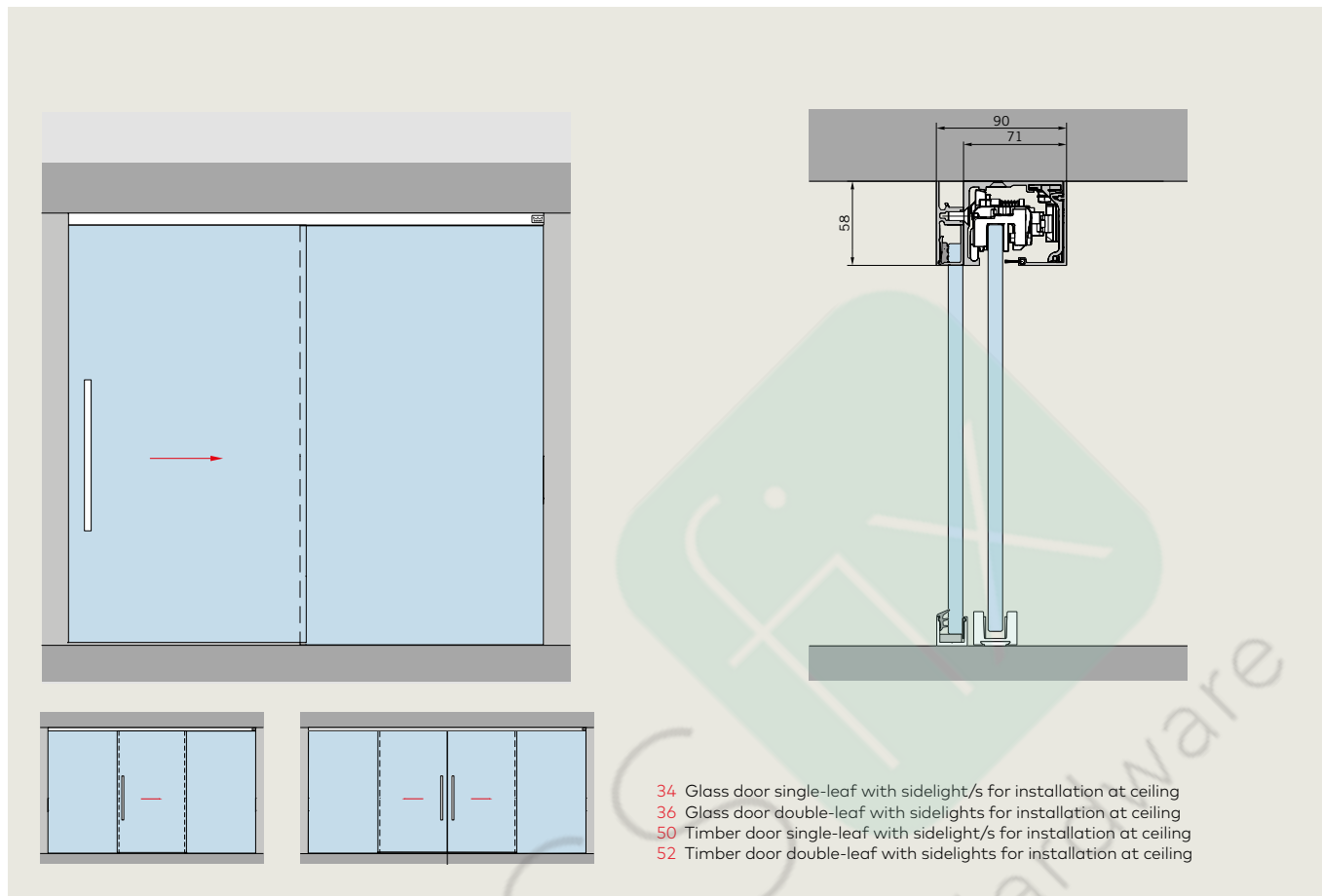

Sliding

Example view for MUTO Comfort L 80 with glass overpanel and glass sidelights

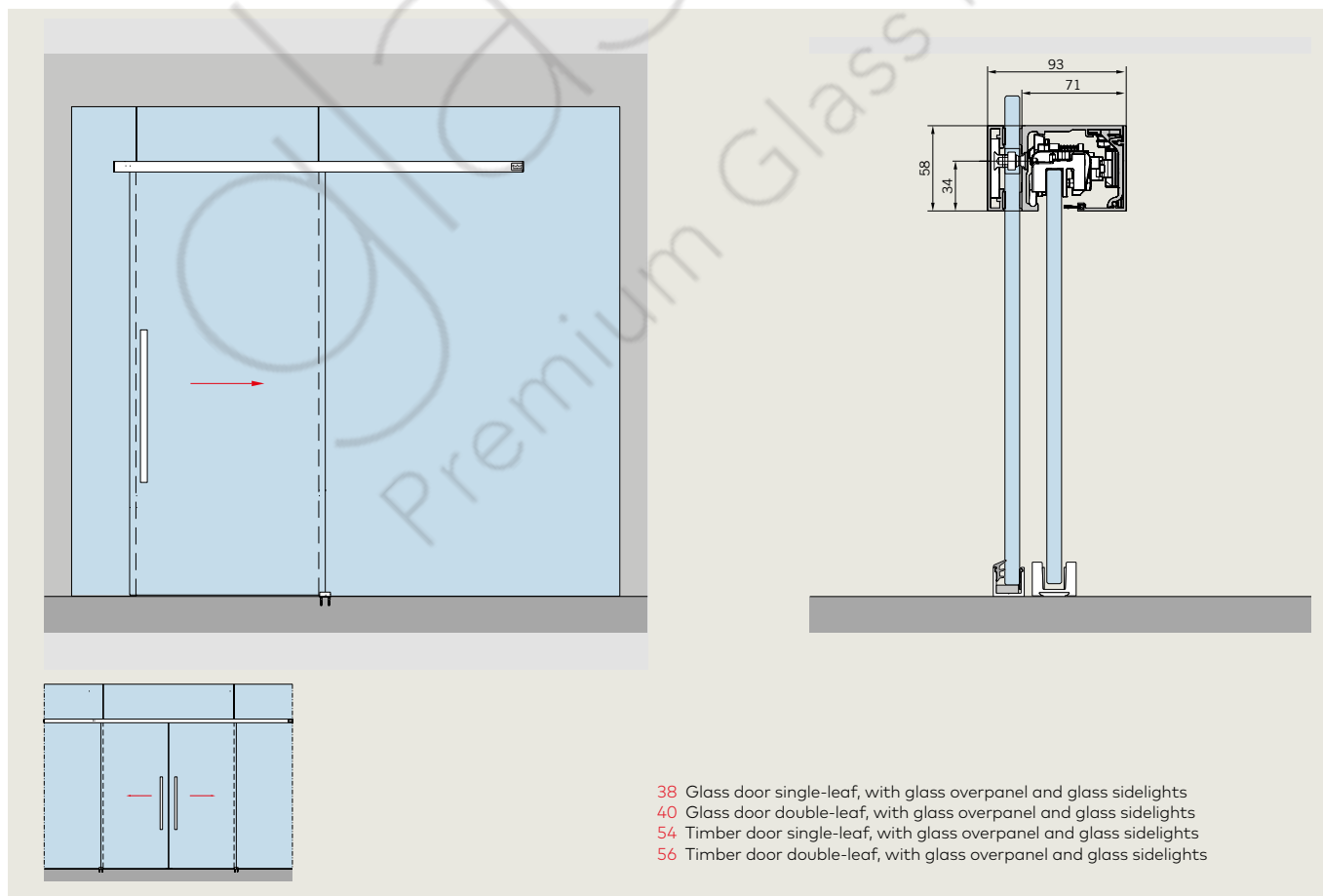

Glass door (8–13,5 mm) single-leaf, installation at wall

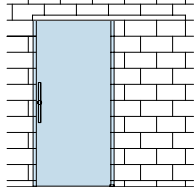

AL silver anod (150)	AL niro anod (157)	AL white p-coat (350)	AL special color anod (199)	AL special color p-coat (399)
				*

Art. No.	Description	€/Piece	€/Piece	€/Piece	€/Piece	€/Piece
----------	-------------	---------	---------	---------	---------	---------

Complete sets (optional with DORMOTION)

Defined lengths

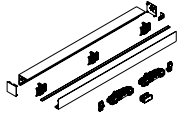

<b>36.300</b>	<b>MUTO Comfort L 80 for 1100 mm panel width</b> consisting of: 1 track profile 2180 mm 1 cover profile 2180 mm 2 clamp carriers (for 8–13.5 mm glass thickness) with anti-jump mechanism 2 endstops with safety catch and anti jump device 1 floor guide 2 end caps incl. view protection brushes 2180 mm	298,00	321,00	298,00	379,00	379,00
---------------	--	--------	--------	--------	--------	--------

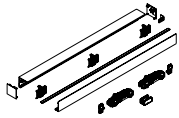

<b>36.301</b>	<b>MUTO Comfort L 80 for 1450 mm panel width</b> consisting of: 1 track profile 2880 mm 1 cover profile 2880 mm 2 clamp carriers (for 8–13.5 mm glass thickness) with anti-jump mechanism 2 endstops with safety catch and anti jump device 1 floor guide 2 end caps incl. view protection brushes 2880 mm	401,00	441,00	401,00	484,00	484,00
---------------	--	--------	--------	--------	--------	--------

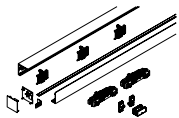

Individual lengths



<b>36.320</b>	<b>MUTO Comfort L 80 for 2000 mm panel width</b> consisting of: 1 track profile max. 4000 mm 1 cover profile max. 4000 mm 2 clamp carriers (for 8–13.5 mm glass thickness) with anti-jump mechanism 2 endstops with safety catch and anti jump device 1 floor guide 2 end caps incl. view protection brushes max. 4000 mm	Basic 2180 mm Surcharge per mm Max. 4000 mm	298,00	321,00	298,00	379,00	379,00
			0,30	0,30	0,30	0,30	0,30

\* With assemblies in special color (399) the end caps will be delivered in plastic anthracite-grey solid-colored.

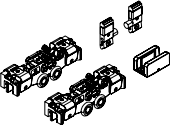
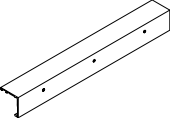
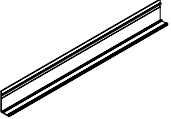
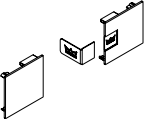
## Glass door (8–13,5 mm) single-leaf, installation at wall

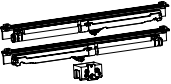
Art. No.	Description	Base parts (000)	AL silver anod (150)	AL niro anod (157)	AL white p-coat (350)	AL special color anod (199)	AL special color p-coat (399)
		€/Piece	€/Piece	€/Piece	€/Piece	€/Piece	€/Piece
<b>Single components</b>							
	<b>36.349 MUTO Comfort L 80 accessories set</b> consisting of: 2 clamp carriers 2 endstops 1 floor guide	190,00	190,00				
	<b>36.350 MUTO Comfort L 80 track profile for installation at wall</b> stock length 6000 mm	235,00	273,00	235,00	328,00	328,00	
	<b>36.351</b> in fixed length	49,00	57,00	49,00	68,00	68,00	
	<b>36.359 MUTO Comfort L 80 cover profile</b> stock length 6000 mm	92,00	105,00	92,00	127,00	127,00	
	<b>36.360</b> in fixed length	19,00	21,50	19,00	26,50	26,50	
	<b>36.354 MUTO Comfort L 80 end caps</b> for installation at wall and ceiling	11,50	11,50	11,50			11,50
	<b>36.265 MUTO set of view protection brushes for Comfort M, L and Premium XL</b> consisting of: 1 view protection brush 8–10 mm glass thickness 1 view protection brush 12–13.5 mm glass thickness	9,80					
<b>Single components (optionally retrofittable)</b>							
	<b>36.361 MUTO Comfort L 80 DORMOTION unit, Version 2017</b> for max. 80 kg, incl. starter min. panel width 660 mm max. panel width 2000 mm	92,00					

\* With assemblies in special color (399) the end caps will be delivered in plastic anthracite-grey solid-colored.

LSG accessories, Status-indicator and integrated locking mechanism on pages 130–131.

**Glass door (8 – 13.5 mm) double-leaf, for installation at wall, (optional with Synchro)**

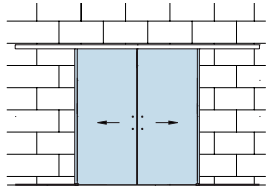

AL silver anod (150)	AL niro anod (157)	AL white p-coat (350)	AL special color anod (199)	AL special color p-coat (399)
				*

Art. No.	Description	€/Piece	€/Piece	€/Piece	€/Piece	€/Piece
----------	-------------	---------	---------	---------	---------	---------

**Complete sets (optional with DORMOTION, Synchro)**

**Individual lengths**

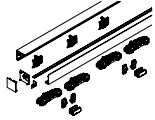



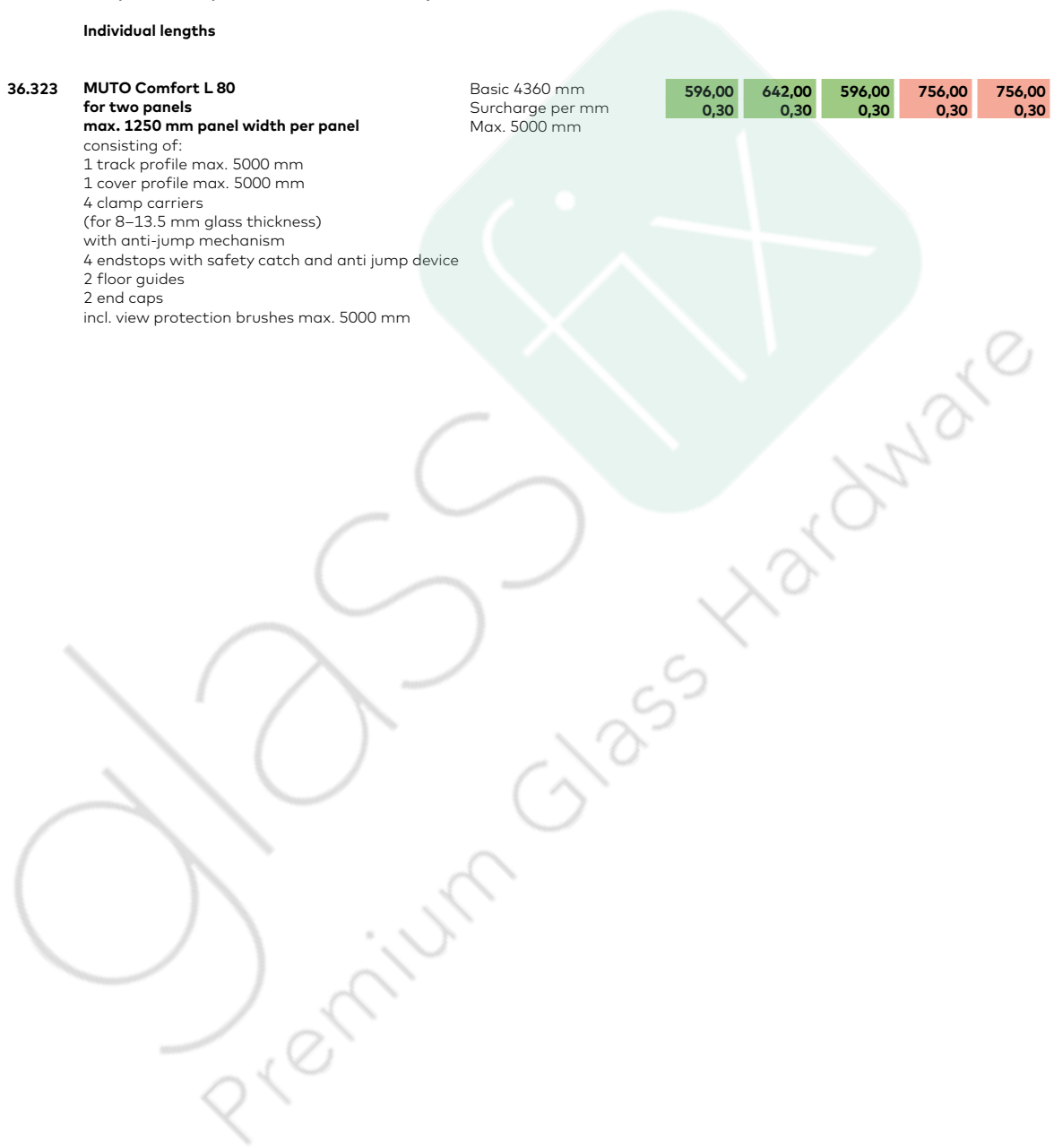

<b>36.323</b>	<b>MUTO Comfort L 80 for two panels</b> <b>max. 1250 mm panel width per panel</b> consisting of: 1 track profile max. 5000 mm 1 cover profile max. 5000 mm 4 clamp carriers (for 8–13.5 mm glass thickness) with anti-jump mechanism 4 endstops with safety catch and anti jump device 2 floor guides 2 end caps incl. view protection brushes max. 5000 mm	Basic 4360 mm Surcharge per mm Max. 5000 mm	<b>596,00</b>	<b>642,00</b>	<b>596,00</b>	<b>756,00</b>	<b>756,00</b>
			<b>0,30</b>	<b>0,30</b>	<b>0,30</b>	<b>0,30</b>	<b>0,30</b>

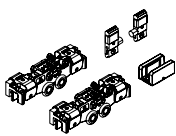
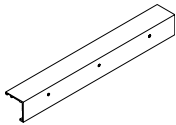
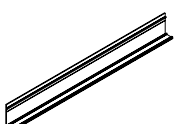
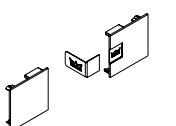

\* With assemblies in special color (399) the end caps will be delivered in plastic anthracite-grey solid-colored.

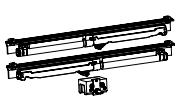
## Glass door (8 – 13.5 mm) double-leaf, for installation at wall, (optional with Synchro)

Art. No.	Description	Base parts (000)	AL	AL	AL	AL	AL
			silver anod (150)	niro anod (157)	white p-coat (350)	special color anod (199)	special color p-coat (399)
		€/Piece	€/Piece	€/Piece	€/Piece	€/Piece	€/Piece
<b>Single components</b>							
	<b>36.349 MUTO Comfort L 80 accessories set</b> consisting of: 2 clamp carriers 2 endstops 1 floor guide	190,00	190,00				
	<b>36.350 MUTO Comfort L 80 track profile for installation at wall</b> stock length 6000 mm	235,00	273,00	235,00	328,00	328,00	
	<b>36.351</b> in fixed length	€/m 49,00	€/m 57,00	€/m 49,00	€/m 68,00	€/m 68,00	
	<b>36.359 MUTO Comfort L 80 cover profile</b> stock length 6000 mm	92,00	105,00	92,00	127,00	127,00	
	<b>36.360</b> in fixed length	€/m 19,00	€/m 21,50	€/m 19,00	€/m 26,50	€/m 26,50	
	<b>36.354 MUTO Comfort L 80 end caps</b> for installation at wall and ceiling	11,50	11,50	11,50			11,50
	<b>36.265 MUTO set of view protection brushes for Comfort M, L and Premium XL</b> consisting of: 1 view protection brush 8–10 mm glass thickness 1 view protection brush 12–13.5 mm glass thickness	€/m 9,80					
<b>Single components (optionally retrofittable)</b>							
	<b>36.361 MUTO Comfort L 80 DORMOTION unit, Version 2017</b> for max. 80 kg, incl. starter min. panel width 660 mm max. panel width 2000 mm	92,00					
	<b>36.357 MUTO Comfort L 80 Synchro-Set</b> for max. 80 kg consisting of: 1 elastic rope 2 deflexion roller	257,00					

\* With assemblies in special color (399) the end caps will be delivered in plastic anthracite-grey solid-colored.

Glass door (8–13,5 mm) single-leaf for installation at ceiling

Sliding

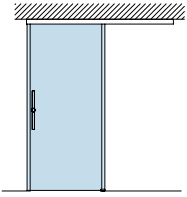

AL silver anod (150)	AL niro anod (157)	AL white p-coat (350)	AL special color anod (199)	AL special color p-coat (399)
				*

Art. No.	Description	€/Piece	€/Piece	€/Piece	€/Piece	€/Piece
----------	-------------	---------	---------	---------	---------	---------

Complete sets (optional with DORMOTION)

Defined lengths

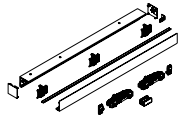

**36.302 MUTO Comfort L 80 for 1100 mm panel width**  
 consisting of:  
 1 track profile 2180 mm  
 1 cover profile 2180 mm  
 2 clamp carriers  
 (for 8–13.5 mm glass thickness)  
 with anti-jump mechanism  
 2 endstops with safety catch and anti jump device  
 1 floor guide  
 2 end caps  
 incl. view protection brushes 2180 mm

298,00	321,00	298,00	379,00	379,00
--------	--------	--------	--------	--------

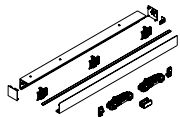

**36.303 MUTO Comfort L 80 for 1450 mm panel width**  
 consisting of:  
 1 track profile 2880 mm  
 1 cover profile 2880 mm  
 2 clamp carriers  
 (for 8–13.5 mm glass thickness)  
 with anti-jump mechanism  
 2 endstops with safety catch and anti jump device  
 1 floor guide  
 2 end caps  
 incl. view protection brushes 2880 mm

401,00	441,00	401,00	484,00	484,00
--------	--------	--------	--------	--------

Individual lengths

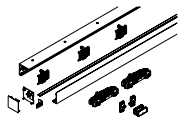



**36.321 MUTO Comfort L 80 for 2000 mm panel width**  
 consisting of:  
 1 track profile max. 4000 mm  
 1 cover profile max. 4000 mm  
 2 clamp carriers  
 (for 8–13.5 mm glass thickness)  
 with anti-jump mechanism  
 2 endstops with safety catch and anti jump device  
 1 floor guide  
 2 end caps  
 incl. view protection brushes max. 4000 mm

Basic 2180 mm  
 Surcharge per mm  
 Max. 4000 mm

298,00	321,00	298,00	379,00	379,00
0,30	0,30	0,30	0,30	0,30

\* With assemblies in special color (399) the end caps will be delivered in plastic anthracite-grey solid-colored.

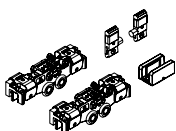
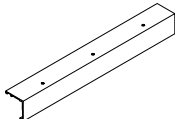
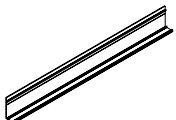
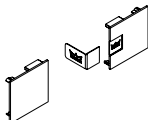
### Glass door (8–13,5 mm) single-leaf for installation at ceiling

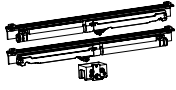
Art. No.	Description	Base parts (000)	AL silver anod (150)	AL niro anod (157)	AL white p-coat (350)	AL special color anod (199)	AL special color p-coat (399)
		€/Piece	€/Piece	€/Piece	€/Piece	€/Piece	€/Piece
<b>Single components</b>							
	<b>36.349 MUTO Comfort L 80 accessories set</b> consisting of: 2 clamp carriers 2 endstops 1 floor guide	190,00	190,00				
	<b>36.352 MUTO Comfort L 80 track profile for installation at ceiling</b> stock length 6000 mm	235,00 €/m	273,00 €/m	235,00 €/m	328,00 €/m	328,00 €/m	
	<b>36.353</b> in fixed length	49,00	57,00	49,00	68,00	68,00	
	<b>36.359 MUTO Comfort L 80 cover profile</b> stock length 6000 mm	92,00 €/m	105,00 €/m	92,00 €/m	127,00 €/m	127,00 €/m	
	<b>36.360</b> in fixed length	19,00	21,50	19,00	26,50	26,50	
	<b>36.354 MUTO Comfort L 80 end caps</b> for installation at wall and ceiling	11,50	11,50	11,50			11,50
	<b>36.265 MUTO set of view protection brushes for Comfort M, L and Premium XL</b> consisting of: 1 view protection brush 8–10 mm glass thickness 1 view protection brush 12–13.5 mm glass thickness	9,80 €/m					
<b>Single components (optionally retrofittable)</b>							
	<b>36.361 MUTO Comfort L 80 DORMOTION unit, Version 2017</b> for max. 80 kg, incl. starter min. panel width 660 mm max. panel width 2000 mm	92,00					

\* With assemblies in special color (399) the end caps will be delivered in plastic anthracite-grey solid-colored.

**Glass door (8–13,5 mm) double-leaf for installation at ceiling (optional with Synchro)**

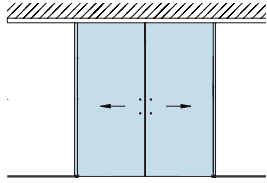

AL silver anod (150)	AL niro anod (157)	AL white p-coat (350)	AL special color anod (199)	AL special color p-coat (399)
				*

Art. No.	Description	€/Piece	€/Piece	€/Piece	€/Piece	€/Piece
----------	-------------	---------	---------	---------	---------	---------

**Complete sets (optional with DORMOTION, Synchro)**

**Individual lengths**

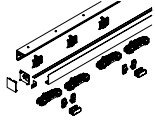



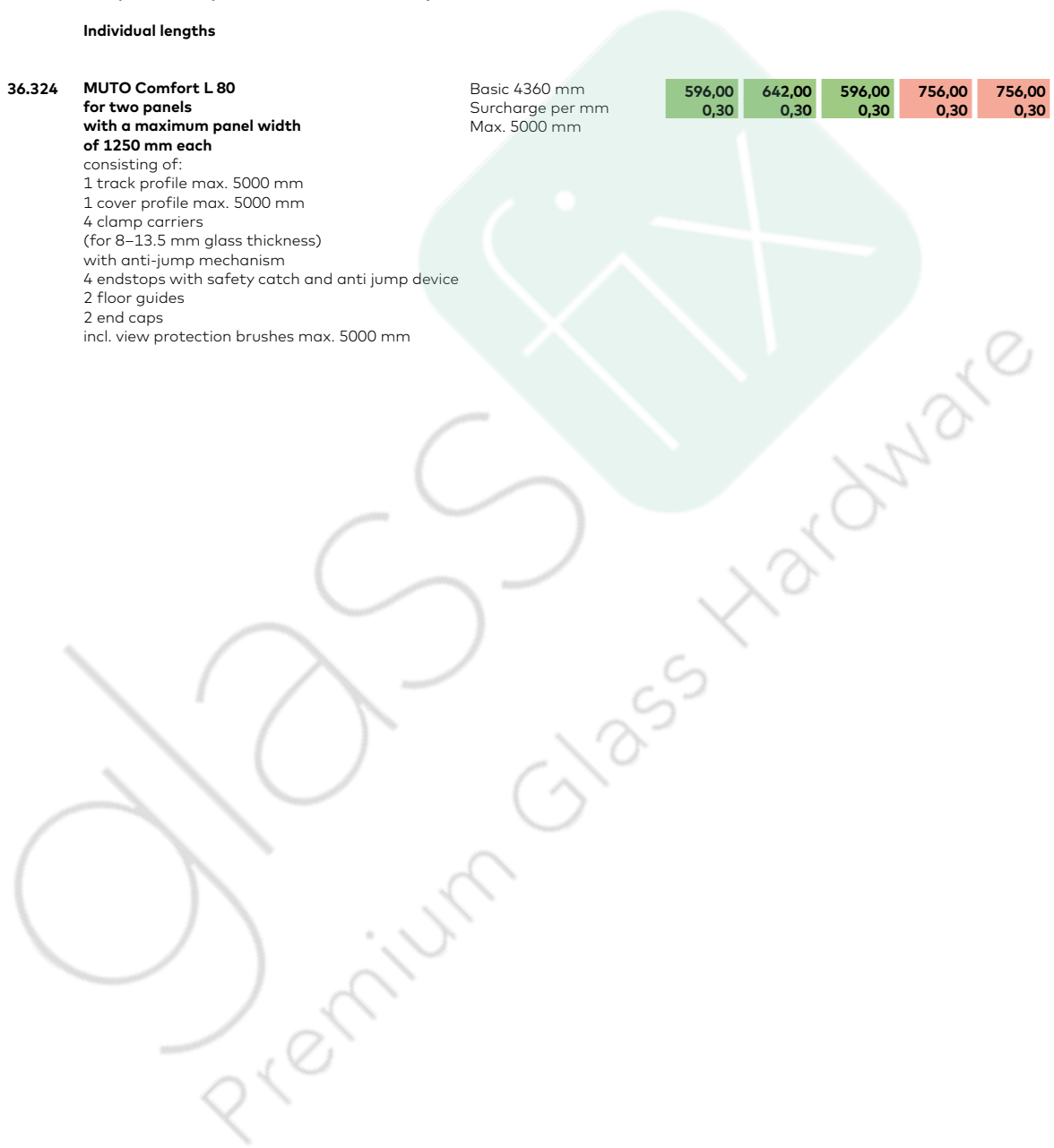

36.324	<b>MUTO Comfort L 80 for two panels with a maximum panel width of 1250 mm each</b> consisting of: 1 track profile max. 5000 mm 1 cover profile max. 5000 mm 4 clamp carriers (for 8–13.5 mm glass thickness) with anti-jump mechanism 4 endstops with safety catch and anti jump device 2 floor guides 2 end caps incl. view protection brushes max. 5000 mm	Basic 4360 mm	<b>596,00</b>	<b>642,00</b>	<b>596,00</b>	<b>756,00</b>	<b>756,00</b>
		Surcharge per mm Max. 5000 mm	<b>0,30</b>	<b>0,30</b>	<b>0,30</b>	<b>0,30</b>	<b>0,30</b>



\* With assemblies in special color (399) the end caps will be delivered in plastic anthracite-grey solid-colored.

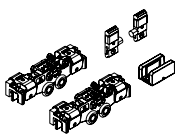
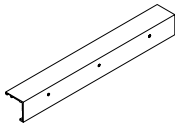
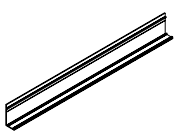
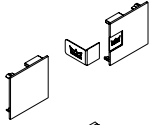

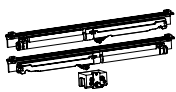
## Glass door (8–13,5 mm) double-leaf for installation at ceiling (optional with Synchro)

Art. No.	Description	Base parts (000)	AL silver anod (150)	AL niro anod (157)	AL white p-coat (350)	AL special color anod (199)	AL special color p-coat (399)
		€/Piece	€/Piece	€/Piece	€/Piece	€/Piece	€/Piece
<b>Single components</b>							
	<b>36.349 MUTO Comfort L 80 accessories set</b> consisting of: 2 clamp carriers 2 endstops 1 floor guide	190,00	190,00				
	<b>36.352 MUTO Comfort L 80 track profile for installation at ceiling</b> stock length 6000 mm	235,00	273,00	235,00	328,00	328,00	
	<b>36.353</b> in fixed length	€/m 49,00	€/m 57,00	€/m 49,00	€/m 68,00	€/m 68,00	
	<b>36.359 MUTO Comfort L 80 cover profile</b> stock length 6000 mm	92,00	105,00	92,00	127,00	127,00	
	<b>36.360</b> in fixed length	€/m 19,00	€/m 21,50	€/m 19,00	€/m 26,50	€/m 26,50	
	<b>36.354 MUTO Comfort L 80 end caps</b> for installation at wall and ceiling	11,50	11,50	11,50			11,50
	<b>36.265 MUTO set of view protection brushes for Comfort M, L and Premium XL</b> consisting of: 1 view protection brush 8–10 mm glass thickness 1 view protection brush 12–13.5 mm glass thickness	€/m 9,80					
<b>Single components (optionally retrofittable)</b>							
	<b>36.361 MUTO Comfort L 80 DORMOTION unit, Version 2017</b> for max. 80 kg, incl. starter min. panel width 660 mm max. panel width 2000 mm	92,00					
	<b>36.357 MUTO Comfort L 80 Synchro-Set</b> for max. 80 kg consisting of: 1 elastic rope 2 deflexion roller	257,00					

\* With assemblies in special color (399) the end caps will be delivered in plastic anthracite-grey solid-colored.

LSG accessories, Status-indicator and integrated locking mechanism on pages 130–131.

**Glass door (8–13,5 mm) single-leaf with glass sidelight/s installation at ceiling**

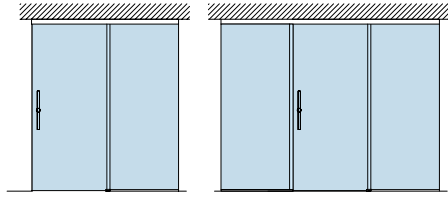

Base parts (000)	AL silver anod (150)	AL niro anod (157)	AL white p-coat (350)	AL special color anod (199)	AL special color p-coat (399)
					*

Art. No.	Description	€/Piece	€/Piece	€/Piece	€/Piece	€/Piece
----------	-------------	---------	---------	---------	---------	---------

**Complete sets (optional with DORMOTION)**

<b>36.306</b>	<b>MUTO Comfort L 80 for max. 2000 mm panel width</b>	Basic 2180 mm Surcharge per mm Max. 4000 mm	393,00	428,00	393,00	505,00	505,00
			0,30	0,30	0,30	0,40	0,40

consisting of:  
 1 track profile max. 4000 mm for sidelight connection  
 1 cover profile max. 4000 mm  
 1 sidelight profile max. 4000 mm  
 1 view protection profile depending on panel and sidelight  
 1 filling profile depending on panel and sidelight  
 2 clamp carriers (for 8–13.5 mm glass thickness) with anti-jump mechanism  
 2 endstops with safety catch and anti jump device  
 1 floor guide  
 2 end caps  
 incl. view protection brushes max. 4000 mm

**Single components**

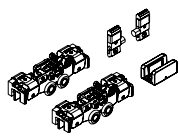

<b>36.349</b>	<b>MUTO Comfort L 80 accessories set</b>	190,00	190,00	190,00
---------------	--	--------	--------	--------

consisting of:  
 2 clamp carriers  
 2 endstops  
 1 floor guide

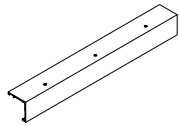

<b>36.352</b>	<b>MUTO Comfort L 80 track profile for installation at ceiling</b> stock length 6000 mm	235,00	273,00	235,00	328,00	328,00
		€/m	€/m	€/m	€/m	€/m
<b>36.353</b>	in fixed length	49,00	57,00	49,00	68,00	68,00

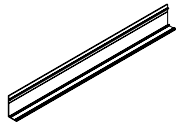

<b>36.359</b>	<b>MUTO Comfort L 80 cover profile</b> stock length 6000 mm	92,00	105,00	92,00	127,00	127,00
		€/m	€/m	€/m	€/m	€/m
<b>36.360</b>	in fixed length	19,00	21,50	19,00	26,50	26,50



<b>36.265</b>	<b>MUTO set of view protection brushes for Comfort M, L and Premium XL</b>	€/m	9,80
---------------	--	-----	------

consisting of:  
 1 view protection brush 8–10 mm glass thickness  
 1 view protection brush 12–13.5 mm glass thickness

**Single components (optionally retrofittable)**

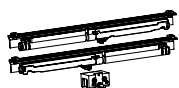

<b>36.361</b>	<b>MUTO Comfort L 80 DORMOTION unit, Version 2017</b>	92,00
---------------	---	-------



for max. 80 kg, incl. starter  
 min. panel width 660 mm  
 max. panel width 2000 mm

**Delivery status of side panel profile:**  
 as part of complete sets = pre-drilled  
 as single components = undrilled

\* With assemblies in special color (399) the end caps will be delivered in plastic anthracite-grey solid-colored.

LSG accessories, Status-indicator and integrated locking mechanism on pages 130–131.

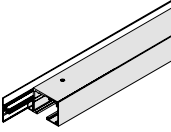
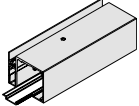
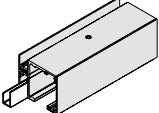
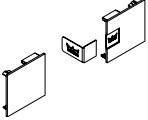
## Glass door (8–13,5 mm) single-leaf with glass sidelight/s installation at ceiling

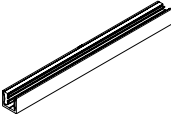
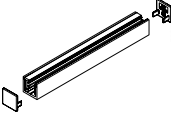
Art. No.	Description	AL silver anod (150)	AL niro anod (157)	AL white p-coat (350)	AL special color anod (199)	AL special color p-coat (399) *	
		€/m	€/m	€/m	€/m	€/m	
<b>Single components</b>							
	<b>MUTO Comfort L 80 side panel profile</b>						
	58 mm height, with all gaskets, for 8–13,5 mm glass thickness stock length 6000 mm in fixed length	€/Piece	115,00	130,00	115,00	158,00	158,00
36.271			23,50	27,50	23,50	33,00	33,00
36.274							
	<b>MUTO view protection profile</b>						
	for Comfort L, Premium XL and Premium Self-Closing, for side panel profile stock length 6000 mm in fixed length	€/Piece	68,00	78,50	68,00	94,00	94,00
36.800			14,50	16,50	14,50	19,50	19,50
36.801							
	<b>MUTO Filling profile</b>						
	for Comfort L, Premium XL and Premium Self-Closing stock length 6000 mm in fixed length	€/Piece	68,00	78,50	68,00	94,00	94,00
36.802			14,50	16,50	14,50	19,50	19,50
36.803							
	<b>MUTO Comfort L 80 end caps</b>						
	for installation at wall and ceiling	€/Piece	11,50	11,50	11,50		11,50
36.354							
	<b>MUTO Comfort L 80 end caps</b>						
	for side panel profile, 58 mm height	€/Piece	11,50	11,50	11,50		11,50
36.273							
	<b>MUTO Floor profile</b>						
	incl. 2 end caps for Comfort L, Premium XL and Premium Self-Closing for side panel fixing, complete with all gaskets, for 8–13,5 mm glass thickness stock length 6000 mm in fixed length	€/Piece	117,00	134,00	117,00	161,00	161,00
36.810			24,50	28,00	24,50	33,50	33,50
36.811							
	<b>MUTO end caps (2 pcs.)</b>						
	for Comfort L, Premium XL and Premium Self-Closing for floor profile - side panel fixing	€/Piece	8,00	8,00	8,00		8,00
36.812							

**Delivery status of side panel profile:**  
as part of complete sets = pre-drilled  
as single components = undrilled

\* With assemblies in special color (399) the end caps will be delivered in plastic anthracite-grey solid-colored.

**Glass door (8–13,5 mm) double-leaf with glass sidelights installation at ceiling (optional with Synchro)**

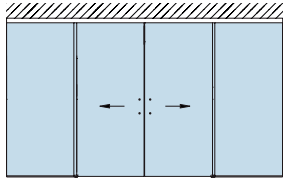

Base parts (000)	AL silver anod (150)	AL niro anod (157)	AL white p-coat (350)	AL special color anod (199)	AL special color p-coat (399)
					*

Art. No.	Description	€/Piece	€/Piece	€/Piece	€/Piece	€/Piece	€/Piece
----------	-------------	---------	---------	---------	---------	---------	---------

**Single components**

	<b>36.349</b>	<b>MUTO Comfort L 80 accessories set</b> consisting of: 2 clamp carriers 2 endstops 1 floor guide	<b>190,00</b>	<b>190,00</b>				
	<b>36.352</b>	<b>MUTO Comfort L 80 track profile for installation at ceiling</b> stock length 6000 mm	<b>235,00</b>	<b>273,00</b>	<b>235,00</b>	<b>328,00</b>	<b>328,00</b>	
			€/m	€/m	€/m	€/m	€/m	€/m
	<b>36.353</b>	in fixed length	<b>49,00</b>	<b>57,00</b>	<b>49,00</b>	<b>68,00</b>	<b>68,00</b>	
	<b>36.359</b>	<b>MUTO Comfort L 80 cover profile</b> stock length 6000 mm	<b>92,00</b>	<b>105,00</b>	<b>92,00</b>	<b>127,00</b>	<b>127,00</b>	
			€/m	€/m	€/m	€/m	€/m	€/m
	<b>36.360</b>	in fixed length	<b>19,00</b>	<b>21,50</b>	<b>19,00</b>	<b>26,50</b>	<b>26,50</b>	
	<b>36.265</b>	<b>MUTO set of view protection brushes for Comfort M, L and Premium XL</b> consisting of: 1 view protection brush 8–10 mm glass thickness 1 view protection brush 12–13.5 mm glass thickness	€/m	<b>9,80</b>				

**Single components (optionally retrofittable)**



	<b>36.361</b>	<b>MUTO Comfort L 80 DORMOTION unit, Version 2017</b> for max. 80 kg, incl. starter min. panel width 660 mm max. panel width 2000 mm	<b>92,00</b>				
	<b>36.357</b>	<b>MUTO Comfort L 80 Synchro-Set</b> for max. 80 kg consisting of: 1 elastic rope 2 deflexion roller	<b>257,00</b>				

**Delivery status of side panel profile:**  
as part of complete sets = pre-drilled  
as single components = undrilled

\* With assemblies in special color (399) the end caps will be delivered in plastic anthracite-grey solid-colored.

LSG accessories, Status-indicator and integrated locking mechanism on pages 130–131.

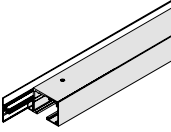
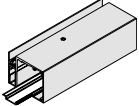
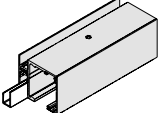
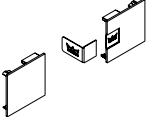
## Glass door (8–13,5 mm) double-leaf with glass sidelights installation at ceiling (optional with Synchro)

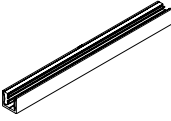
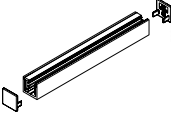
Art. No.	Description	AL silver anod (150)	AL niro anod (157)	AL white p-coat (350)	AL special color anod (199)	AL special color p-coat (399)	
		€/m	€/m	€/m	€/m	€/m	
<b>Single components</b>							
	<b>MUTO Comfort L 80 side panel profile</b>						
	58 mm height, with all gaskets, for 8–13,5 mm glass thickness stock length 6000 mm in fixed length	€ / Piece	115,00	130,00	115,00	158,00	158,00
36.271			23,50	27,50	23,50	33,00	33,00
36.274							
	<b>MUTO view protection profile</b>						
	for Comfort L, Premium XL and Premium Self-Closing, for side panel profile stock length 6000 mm in fixed length	€ / Piece	68,00	78,50	68,00	94,00	94,00
36.800			14,50	16,50	14,50	19,50	19,50
36.801							
	<b>MUTO Filling profile</b>						
	for Comfort L, Premium XL and Premium Self-Closing stock length 6000 mm in fixed length	€ / Piece	68,00	78,50	68,00	94,00	94,00
36.802			14,50	16,50	14,50	19,50	19,50
36.803							
	<b>MUTO Comfort L 80 end caps</b>						
	for installation at wall and ceiling	€ / Piece	11,50	11,50	11,50		11,50
36.354							
	<b>MUTO Comfort L 80 end caps</b>						
	for side panel profile, 58 mm height	€ / Piece	11,50	11,50	11,50		11,50
36.273							
	<b>MUTO Floor profile incl. 2 end caps</b>						
	for Comfort L, Premium XL and Premium Self-Closing for side panel fixing, complete with all gaskets, for 8–13,5 mm glass thickness stock length 6000 mm in fixed length	€ / Piece	117,00	134,00	117,00	161,00	161,00
36.810			24,50	28,00	24,50	33,50	33,50
36.811							
	<b>MUTO end caps (2 pcs.)</b>						
	for Comfort L, Premium XL and Premium Self-Closing for floor profile - side panel fixing	€ / Piece	8,00	8,00	8,00		8,00
36.812							

**Delivery status of side panel profile:**  
as part of complete sets = pre-drilled  
as single components = undrilled

\* With assemblies in special color (399) the end caps will be delivered in plastic anthracite-grey solid-colored.

**Glass door (8–13,5 mm) single-leaf with glass overpanel and glass sidelights**

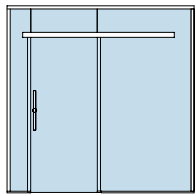

AL silver anod (150)	AL niro anod (157)	AL white p-coat (350)	AL special color anod (199)	AL special color p-coat (399) *
-------------------------------	-----------------------------	--------------------------------	---	--

Art. No.	Description	€/Piece	€/Piece	€/Piece	€/Piece	€/Piece
----------	-------------	---------	---------	---------	---------	---------

**Complete sets (optional with DORMOTION)**

**Defined lengths**

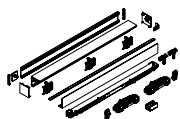

**36.304 MUTO Comfort L 80 for 1050 mm clear opening width / 1110 mm panel width**  
 consisting of:  
 1 track profile 2287 mm  
 1 cover profile 2287 mm  
 1 counter profile 2287 mm  
 2 clamp carriers  
 (for 8–13.5 mm glass thickness)  
 with anti-jump mechanism  
 2 endstops with safety catch and anti jump device  
 1 floor guide  
 2 end caps  
 incl. view protection brushes 2287 mm

482,00	516,00	482,00	568,00	568,00
--------	--------	--------	--------	--------

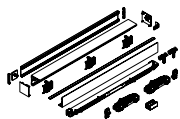

**36.305 MUTO Comfort L 80 for 1250 mm clear opening width / 1310 mm panel width**  
 consisting of:  
 1 track profile 2687 mm  
 1 cover profile 2687 mm  
 1 counter profile 2687 mm  
 2 clamp carriers  
 (for 8–13.5 mm glass thickness)  
 with anti-jump mechanism  
 2 endstops with safety catch and anti jump device  
 1 floor guide  
 2 end caps  
 incl. view protection brushes 2687 mm

602,00	660,00	602,00	727,00	727,00
--------	--------	--------	--------	--------

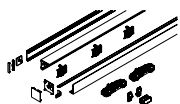

**Individual lengths**



**36.322 MUTO Comfort L 80 for max. 1940 mm clear opening width / max. 2000 mm panel width**  
 Basic 2287 mm  
 Surcharge per mm  
 Max. 4067 mm  
 consisting of:  
 1 track profile max. 4067 mm  
 1 cover profile max. 4067 mm  
 1 counter profile max. 4067 mm  
 2 clamp carriers  
 (for 8–13.5 mm glass thickness)  
 with anti-jump mechanism  
 2 endstops with safety catch and anti jump device  
 1 floor guide  
 2 end caps  
 incl. view protection brushes max. 4067 mm

482,00	516,00	482,00	568,00	568,00
0,30	0,30	0,30	0,30	0,30

\* With assemblies in special color (399) the end caps will be delivered in plastic anthracite-grey solid-colored.

**Glass door (8–13,5 mm) single-leaf with glass overpanel and glass sidelights**

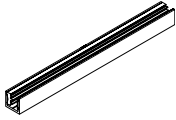
Base parts (000)	AL silver anod (150)	AL niro anod (157)	AL white p-coat (350)	AL special color anod (199)	AL special color p-coat (399)
					*

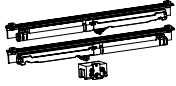
Art. No.	Description	€/Piece	€/Piece	€/Piece	€/Piece	€/Piece	€/Piece
<b>Single components</b>							
	<b>MUTO Floor profile incl. 2 end caps</b> for Comfort L, Premium XL and Premium Self-Closing for side panel fixing, complete with all gaskets, for 8–13,5 mm glass thickness stock length 6000 mm						
<b>36.810</b>		117,00	134,00	117,00	161,00	161,00	
		€/m	€/m	€/m	€/m	€/m	
<b>36.811</b>	in fixed length	24,50	28,00	24,50	33,50	33,50	
	<b>MUTO end caps (2 pcs.)</b> for Comfort L, Premium XL and Premium Self-Closing for floor profile - side panel fixing						
<b>36.812</b>		8,00	8,00	8,00			8,00
<b>Single components (optionally retrofittable)</b>							
	<b>MUTO Comfort L 80 DORMOTION unit, Version 2017</b> for max. 80 kg, incl. starter min. panel width 660 mm max. panel width 2000 mm						
<b>36.361</b>		92,00					

\* With assemblies in special color (399) the end caps will be delivered in plastic anthracite-grey solid-colored.

LSG accessories, Status-indicator and integrated locking mechanism on pages 130–131.

**Glass door (8–13,5 mm) double-leaf with glass overpanel and glass sidelights (optional with Synchro)**

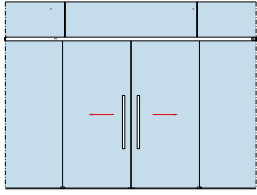

AL silver anod (150)	AL niro anod (157)	AL white p-coat (350)	AL special color anod (199)	AL special color p-coat (399)
				*

Art. No.	Description	€/Piece	€/Piece	€/Piece	€/Piece	€/Piece
----------	-------------	---------	---------	---------	---------	---------

**Complete sets (optional with DORMOTION, Synchro)**

**Individual lengths**

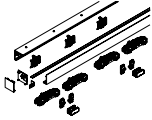

36.325	<b>MUTO Comfort L 80 for two panels with max. 2446 clear opening width / with a maximum panel width of 1250 mm each</b> consisting of: 1 track profile max. 5012 mm 1 cover profile max. 5012 mm 1 counter profile max. 5012 mm 4 clamp carriers (for 8–13.5 mm glass thickness) with anti-jump mechanism 4 endstops with safety catch and anti jump device 2 floor guides 2 end caps incl. view protection brushes max. 5012 mm	Basic 4574 mm Surcharge per mm Max. 5012 mm	963,00	1032,00	963,00	1135,00	1135,00
			0,30	0,30	0,30	0,30	0,30

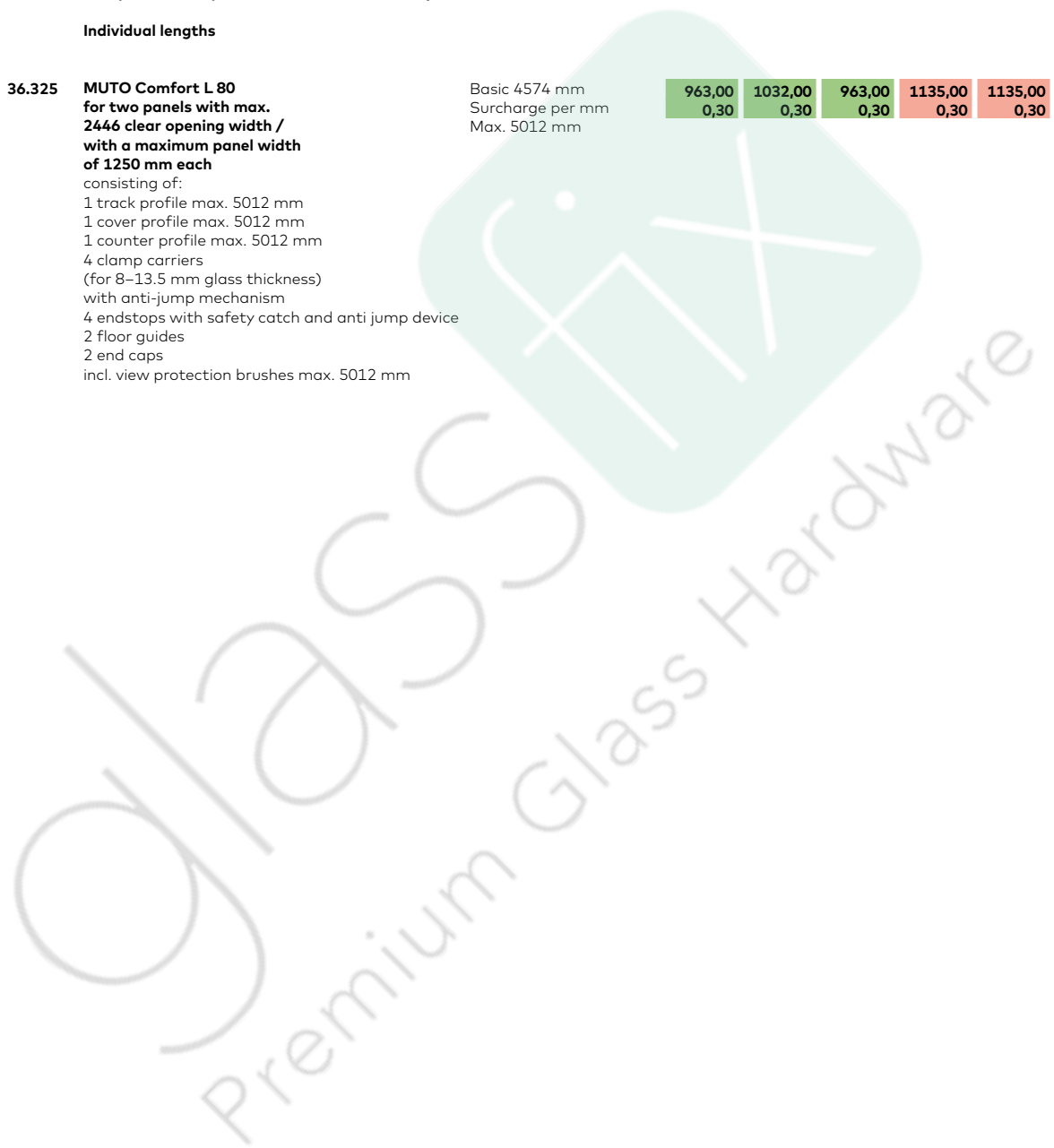



\* With assemblies in special color (399) the end caps will be delivered in plastic anthracite-grey solid-colored.

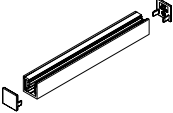
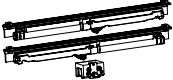

## Glass door (8–13,5 mm) double-leaf with glass overpanel and glass sidelights (optional with Synchro)

Base parts (000)	AL silver anod (150)	AL niro anod (157)	AL white p-coat (350)	AL special color anod (199)	AL special color p-coat (399)
					*

Art. No.	Description	€/Piece	€/Piece	€/Piece	€/Piece	€/Piece	€/Piece
<b>Single components</b>							
	<b>MUTO Floor profile incl. 2 end caps</b> for Comfort L, Premium XL and Premium Self-Closing for side panel fixing, complete with all gaskets, for 8–13,5 mm glass thickness stock length 6000 mm						
36.810		117,00	134,00	117,00	161,00	161,00	
		€/m	€/m	€/m	€/m	€/m	
36.811	in fixed length	24,50	28,00	24,50	33,50	33,50	
	<b>MUTO end caps (2 pcs.)</b> for Comfort L, Premium XL and Premium Self-Closing for floor profile - side panel fixing						
36.812		8,00	8,00	8,00			8,00
<b>Single components (optionally retrofittable)</b>							
	<b>MUTO Comfort L 80 DORMOTION unit, Version 2017</b> for max. 80 kg, incl. starter min. panel width 660 mm max. panel width 2000 mm						
36.361		92,00					
	<b>MUTO Comfort L 80 Synchro-Set</b> for max. 80 kg consisting of: 1 elastic rope 2 deflexion roller						
36.357		257,00					

\* With assemblies in special color (399) the end caps will be delivered in plastic anthracite-grey solid-colored.

LSG accessories, Status-indicator and integrated locking mechanism on pages 130–131.

Timber door (28–50 mm) single-leaf, installation at wall

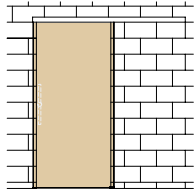

AL silver anod (150)	AL niro anod (157)	AL white p-coat (350)	AL special color anod (199)	AL special color p-coat (399)
				*

Art. No.	Description	€/Piece	€/Piece	€/Piece	€/Piece	€/Piece
----------	-------------	---------	---------	---------	---------	---------

**Complete sets (optional with DORMOTION)  
For Timber door application the adapter profile  
36.261 / 36.262 will be necessitated**

**Defined lengths**

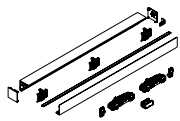

**36.300 MUTO Comfort L 80 for 1100 mm panel width**  
consisting of:  
1 track profile 2180 mm  
1 cover profile 2180 mm  
2 clamp carriers  
(for 8–13.5 mm glass thickness)  
with anti-jump mechanism  
2 endstops with safety catch and anti jump device  
1 floor guide  
2 end caps  
incl. view protection brushes 2180 mm

298,00	321,00	298,00	379,00	379,00
--------	--------	--------	--------	--------

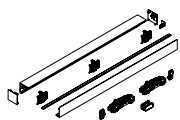

**36.301 MUTO Comfort L 80 for 1450 mm panel width**  
consisting of:  
1 track profile 2880 mm  
1 cover profile 2880 mm  
2 clamp carriers  
(for 8–13.5 mm glass thickness)  
with anti-jump mechanism  
2 endstops with safety catch and anti jump device  
1 floor guide  
2 end caps  
incl. view protection brushes 2880 mm

401,00	441,00	401,00	484,00	484,00
--------	--------	--------	--------	--------

**Individual lengths**

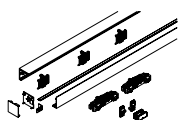

**36.320 MUTO Comfort L 80 for 2000 mm panel width**  
consisting of:  
1 track profile max. 4000 mm  
1 cover profile max. 4000 mm  
2 clamp carriers  
(for 8–13.5 mm glass thickness)  
with anti-jump mechanism  
2 endstops with safety catch and anti jump device  
1 floor guide  
2 end caps  
incl. view protection brushes max. 4000 mm

Basic 2180 mm	298,00	321,00	298,00	379,00	379,00
Surcharge per mm	0,30	0,30	0,30	0,30	0,30
Max. 4000 mm					

\* With assemblies in special color (399) the end caps will be delivered in plastic anthracite-grey solid-colored.



**Timber door (28–50 mm) double-leaf for installation at wall (optional with Synchro)**

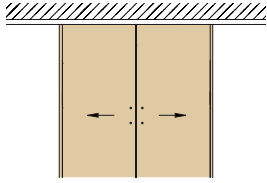

AL silver anod (150)	AL niro anod (157)	AL white p-coat (350)	AL special color anod (199)	AL special color p-coat (399)
				*

Art. No.	Description	€/Piece	€/Piece	€/Piece	€/Piece	€/Piece
----------	-------------	---------	---------	---------	---------	---------

**Complete sets (optional with DORMOTION, Synchro)**  
 For Timber door application the adapter profile 36.261 / 36.262 will be necessitated

**Individual lengths**

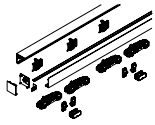

**36.323 MUTO Comfort L 80 for two panels with a maximum panel width of 1250 mm each**

- consisting of:  
 1 track profile max. 5000 mm  
 1 cover profile max. 5000 mm  
 4 clamp carriers (for 8–13.5 mm glass thickness) with anti-jump mechanism  
 4 endstops with safety catch and anti jump device  
 2 floor guides  
 2 end caps  
 incl. view protection brushes max. 5000 mm



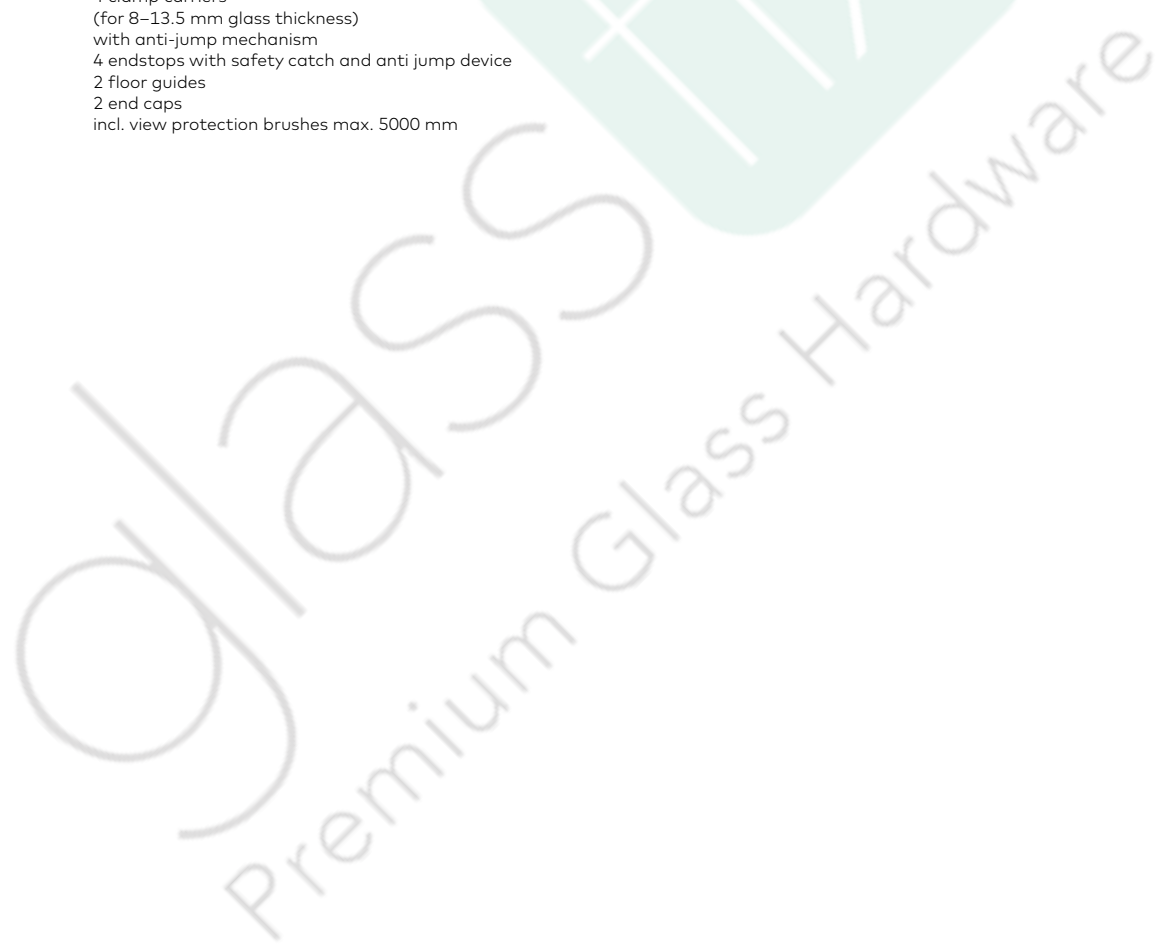

Basic 4360 mm  
 Surcharge per mm  
 Max. 5000 mm

596,00	642,00	596,00	756,00	756,00
0,30	0,30	0,30	0,30	0,30

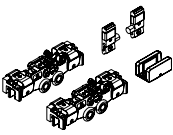
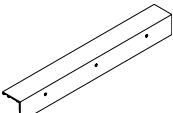

\* With assemblies in special color (399) the end caps will be delivered in plastic anthracite-grey solid-colored.

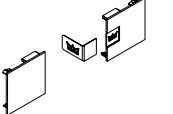
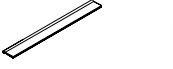
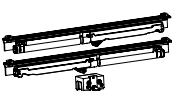
## Timber door (28–50 mm) double-leaf for installation at wall (optional with Synchro)

Art. No.	Description	Base parts (000)	AL silver anod (150)	AL niro anod (157)	AL white p-coat (350)	AL special color anod (199)	AL special color p-coat (399)
		€/Piece	€/Piece	€/Piece	€/Piece	€/Piece	€/Piece
<b>Single components</b>							
	<b>MUTO Comfort L 80 Timber adapter set</b> Profile 12.5 x 36 mm, incl. accessory set (floor guide for timber door panel)						
	<b>36.261</b>	50,00					
		€/m					
	<b>36.262</b> in fixed length max. 2000 mm	63,00					
	<b>36.349 MUTO Comfort L 80 accessories set</b> consisting of: 2 clamp carriers 2 endstops 1 floor guide		190,00	190,00			
							
	<b>MUTO Comfort L 80 track profile for installation at wall</b> stock length 6000 mm		235,00	273,00	235,00	328,00	328,00
	<b>36.350</b>	€/m	€/m	€/m	€/m	€/m	€/m
	<b>36.351</b> in fixed length	49,00	57,00	49,00	68,00	68,00	
	<b>MUTO Comfort L 80 cover profile</b> stock length 6000 mm		92,00	105,00	92,00	127,00	127,00
	<b>36.359</b>	€/m	€/m	€/m	€/m	€/m	€/m
	<b>36.360</b> in fixed length	19,00	21,50	19,00	26,50	26,50	
	<b>36.354 MUTO Comfort L 80 end caps</b> for installation at wall and ceiling		11,50	11,50	11,50		11,50
							
	<b>36.265 MUTO set of view protection brushes for Comfort M, L and Premium XL</b> consisting of: 1 view protection brush 8–10 mm glass thickness 1 view protection brush 12–13.5 mm glass thickness		€/m				
		9,80					
<b>Single components (optionally retrofittable)</b>							
	<b>36.361 MUTO Comfort L 80 DORMOTION unit, Version 2017</b> for max. 80 kg, incl. starter min. panel width 660 mm max. panel width 2000 mm		92,00				
							
	<b>36.357 MUTO Comfort L 80 Synchro-Set</b> for max. 80 kg consisting of: 1 elastic rope 2 deflexion roller		257,00				
							

\* With assemblies in special color (399) the end caps will be delivered in plastic anthracite-grey solid-colored.

Timber door (28–50 mm) single-leaf for installation at ceiling

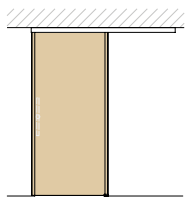

AL silver anod (150)	AL niro anod (157)	AL white p-coat (350)	AL special color anod (199)	AL special color p-coat (399)
				*

Art. No.	Description	€/Piece	€/Piece	€/Piece	€/Piece	€/Piece
----------	-------------	---------	---------	---------	---------	---------

**Complete sets (optional with DORMOTION)  
For Timber door application the adapter profile  
36.261 / 36.262 will be necessitated**

**Defined lengths**

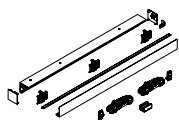

**36.302 MUTO Comfort L 80 for 1100 mm panel width**  
consisting of:  
1 track profile 2180 mm  
1 cover profile 2180 mm  
2 clamp carriers  
(for 8–13.5 mm glass thickness)  
with anti-jump mechanism  
2 endstops with safety catch and anti jump device  
1 floor guide  
2 end caps  
incl. view protection brushes 2180 mm

298,00	321,00	298,00	379,00	379,00
--------	--------	--------	--------	--------

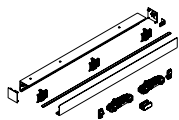

**36.303 MUTO Comfort L 80 for 1450 mm panel width**  
consisting of:  
1 track profile 2880 mm  
1 cover profile 2880 mm  
2 clamp carriers  
(for 8–13.5 mm glass thickness)  
with anti-jump mechanism  
2 endstops with safety catch and anti jump device  
1 floor guide  
2 end caps  
incl. view protection brushes 2880 mm

401,00	441,00	401,00	484,00	484,00
--------	--------	--------	--------	--------

**Individual lengths**

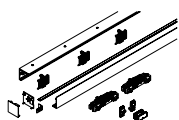

**36.321 MUTO Comfort L 80 for 2000 mm panel width**  
consisting of:  
1 track profile max. 4000 mm  
1 cover profile max. 4000 mm  
2 clamp carriers  
(for 8–13.5 mm glass thickness)  
with anti-jump mechanism  
2 endstops with safety catch and anti jump device  
1 floor guide  
2 end caps  
incl. view protection brushes max. 4000 mm

Basic 2180 mm	298,00	321,00	298,00	379,00	379,00
Surcharge per mm	0,30	0,30	0,30	0,30	0,30
Max. 4000 mm					

\* With assemblies in special color (399) the end caps will be delivered in plastic anthracite-grey solid-colored.

## Timber door (28–50 mm) single-leaf for installation at ceiling

Art. No.	Description	Base parts (000)	AL silver anod (150)	AL niro anod (157)	AL white p-coat (350)	AL special color anod (199)	AL special color p-coat (399)	€ / Piece
<b>Single components</b>								
	<b>MUTO Comfort L 80 Timber adapter set</b> Profile 12.5 x 36 mm, incl. accessory set (floor guide for timber door panel) 1460 mm							50,00
36.261								€/m
36.262	in fixed length max. 2000 mm							63,00
36.349	<b>MUTO Comfort L 80 accessories set</b> consisting of: 2 clamp carriers 2 endstops 1 floor guide							190,00
								190,00
	<b>MUTO Comfort L 80 track profile for installation at ceiling</b> stock length 6000 mm							235,00
36.352								€/m
36.353	in fixed length							49,00
								273,00
								€/m
								57,00
								235,00
								€/m
								49,00
								328,00
								€/m
								68,00
								328,00
								€/m
								68,00
	<b>MUTO Comfort L 80 cover profile</b> stock length 6000 mm							92,00
36.359								€/m
36.360	in fixed length							19,00
								105,00
								€/m
								21,50
								92,00
								€/m
								19,00
								127,00
								€/m
								26,50
								127,00
								€/m
								26,50
36.354	<b>MUTO Comfort L 80 end caps</b> for installation at wall and ceiling							11,50
								11,50
								11,50
								11,50
36.265	<b>MUTO set of view protection brushes for Comfort M, L and Premium XL</b> consisting of: 1 view protection brush 8–10 mm glass thickness 1 view protection brush 12–13.5 mm glass thickness							€/m
								9,80
<b>Single components (optionally retrofittable)</b>								
36.361	<b>MUTO Comfort L 80 DORMOTION unit, Version 2017</b> for max. 80 kg, incl. starter min. panel width 660 mm max. panel width 2000 mm							92,00

\* With assemblies in special color (399) the end caps will be delivered in plastic anthracite-grey solid-colored.

**Timber door (28–50 mm) double-leaf for installation at ceiling (optional with Synchro)**

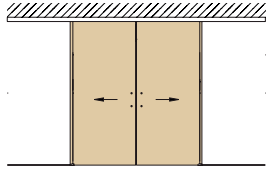

AL silver anod (150)	AL niro anod (157)	AL white p-coat (350)	AL special color anod (199)	AL special color p-coat (399)
----------------------	--------------------	-----------------------	-----------------------------	-------------------------------

\*

Art. No.	Description	€/Piece	€/Piece	€/Piece	€/Piece	€/Piece
----------	-------------	---------	---------	---------	---------	---------

**Complete sets (optional with DORMOTION, Synchro)**  
 For Timber door application the adapter profile 36.261 / 36.262 will be necessitated

**Individual lengths**

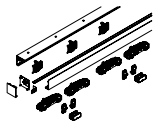

**36.324 MUTO Comfort L 80 for two panels with a maximum panel width of 1250 mm each**

- consisting of:  
 1 track profile max. 5000 mm  
 1 cover profile max. 5000 mm  
 4 clamp carriers (for 8–13.5 mm glass thickness) with anti-jump mechanism  
 4 endstops with safety catch and anti jump device  
 2 floor guides  
 2 end caps  
 incl. view protection brushes max. 5000 mm

Basic 4360 mm  
 Surcharge per mm  
 Max. 5000 mm

596,00	642,00	596,00	756,00	756,00
0,30	0,30	0,30	0,30	0,30

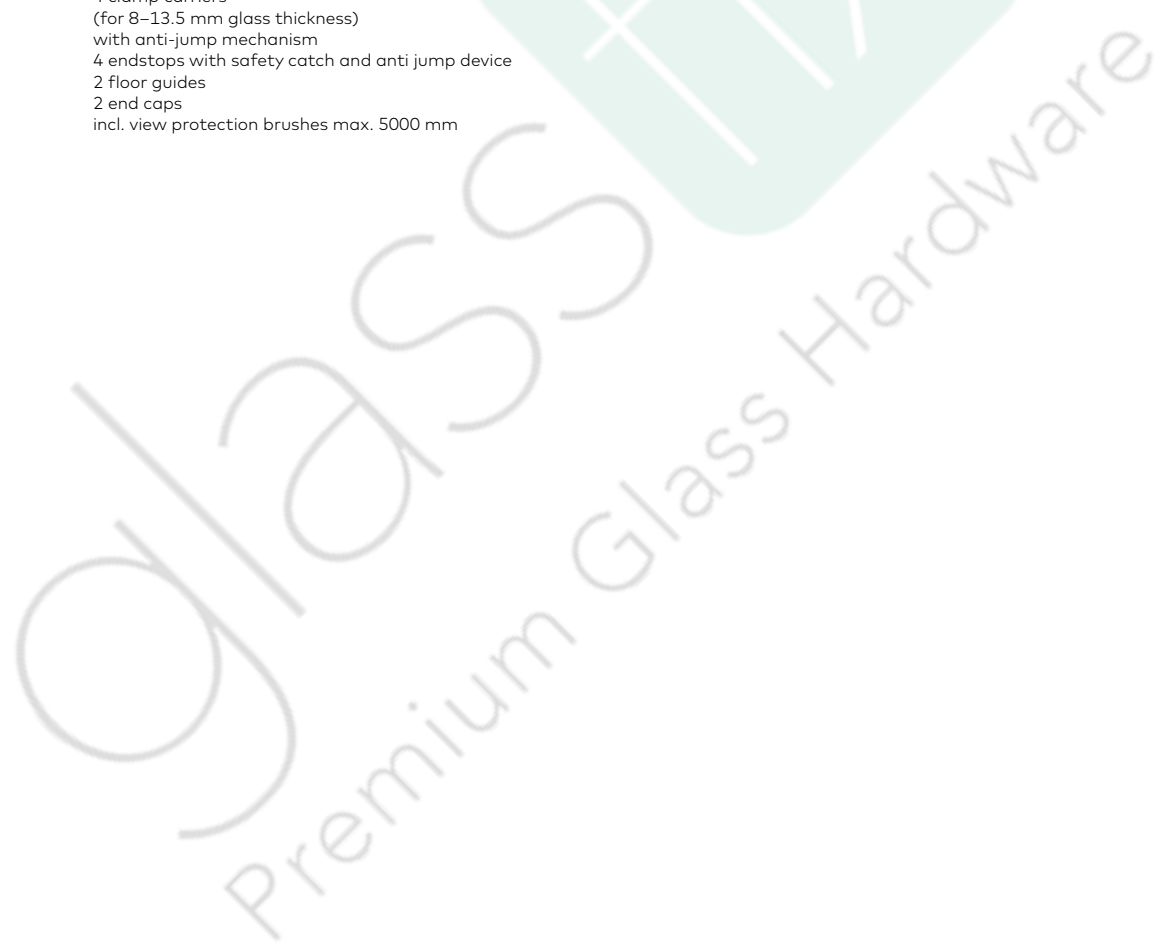

\* With assemblies in special color (399) the end caps will be delivered in plastic anthracite-grey solid-colored.



**Timber door (28–50 mm) double-leaf for installation at ceiling (optional with Synchro)**

Art. No.	Description	Base parts (000)	AL silver anod (150)	AL niro anod (157)	AL white p-coat (350)	AL special color anod (199)	AL special color p-coat (399)
		€/Piece	€/Piece	€/Piece	€/Piece	€/Piece	€/Piece
<b>Single components</b>							
	<b>MUTO Comfort L 80 Timber adapter set</b> Profile 12.5 x 36 mm, incl. accessory set (floor guide for timber door panel) 1460 mm	50,00					
36.261		€/m					
36.262	in fixed length max. 2000 mm	63,00					
36.349	<b>MUTO Comfort L 80 accessories set</b> consisting of: 2 clamp carriers 2 endstops 1 floor guide	190,00	190,00				
36.352	<b>MUTO Comfort L 80 track profile for installation at ceiling</b> stock length 6000 mm	235,00	273,00	235,00	328,00	328,00	
36.353	in fixed length	€/m	€/m	€/m	€/m	€/m	
		49,00	57,00	49,00	68,00	68,00	
36.359	<b>MUTO Comfort L 80 cover profile</b> stock length 6000 mm	92,00	105,00	92,00	127,00	127,00	
36.360	in fixed length	€/m	€/m	€/m	€/m	€/m	
		19,00	21,50	19,00	26,50	26,50	
36.354	<b>MUTO Comfort L 80 end caps</b> for installation at wall and ceiling	11,50	11,50	11,50			11,50
36.265	<b>MUTO set of view protection brushes for Comfort M, L and Premium XL</b> consisting of: 1 view protection brush 8–10 mm glass thickness 1 view protection brush 12–13.5 mm glass thickness	€/m					
		9,80					
<b>Single components (optionally retrofittable)</b>							
36.361	<b>MUTO Comfort L 80 DORMOTION unit, Version 2017</b> for max. 80 kg, incl. starter min. panel width 660 mm max. panel width 2000 mm	92,00					
36.357	<b>MUTO Comfort L 80 Synchro-Set</b> for max. 80 kg consisting of: 1 elastic rope 2 deflexion roller	257,00					

\* With assemblies in special color (399) the end caps will be delivered in plastic anthracite-grey solid-colored.

**Timber door (28–50 mm) single-leaf with glass sidelight/s installation at ceiling**

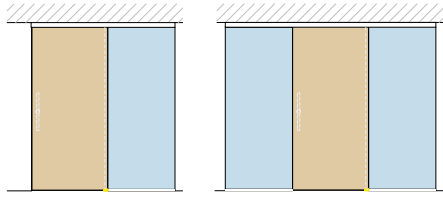

Base parts (000)	AL silver anod (150)	AL niro anod (157)	AL white p-coat (350)	AL special color anod (199)	AL special color p-coat (399)
					*

Art. No.	Description	€/Piece	€/Piece	€/Piece	€/Piece	€/Piece
----------	-------------	---------	---------	---------	---------	---------

**Single components**

For Timber door application the adapter profile 36.261 / 36.262 will be necessitated

**MUTO Comfort L 80 Timber adapter set**

Profile 12.5 x 36 mm, incl. accessory set (floor guide for timber door panel) 1460 mm



36.261 50,00

36.262 in fixed length max. 2000 mm €/m 63,00

**MUTO Comfort L 80 accessories set**

consisting of:  
2 clamp carriers  
2 endstops  
1 floor guide

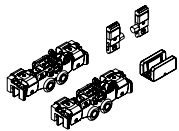

36.349 190,00 190,00

**MUTO Comfort L 80 track profile for installation at ceiling**

stock length 6000 mm

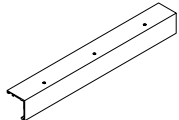

36.352 235,00 273,00 235,00 328,00 328,00

36.353 in fixed length €/m 49,00 €/m 57,00 €/m 49,00 €/m 68,00 €/m 68,00

**MUTO Comfort L 80 cover profile**

stock length 6000 mm

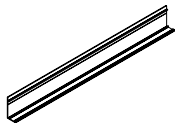

36.359 92,00 105,00 92,00 127,00 127,00

36.360 in fixed length €/m 19,00 €/m 21,50 €/m 19,00 €/m 26,50 €/m 26,50

**MUTO set of view protection brushes for Comfort M, L and Premium XL**

consisting of:  
1 view protection brush 8–10 mm glass thickness  
1 view protection brush 12–13.5 mm glass thickness



36.265 €/m 9,80

**Single components (optionally retrofittable)**

**MUTO Comfort L 80 DORMOTION unit, Version 2017**

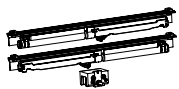

for max. 80 kg, incl. starter  
min. panel width 660 mm  
max. panel width 2000 mm



36.361 92,00

\* With assemblies in special color (399) the end caps will be delivered in plastic anthracite-grey solid-colored.

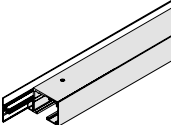
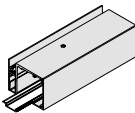
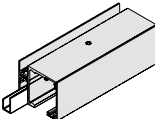
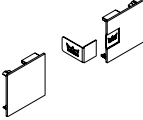
## Timber door (28–50 mm) single-leaf with glass sidelight/ installation at ceiling

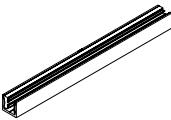
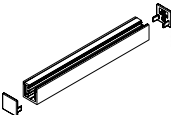
Art. No.	Description	AL silver anod (150)	AL niro anod (157)	AL white p-coat (350)	AL special color anod (199)	AL special color p-coat (399)	
		€/m	€/m	€/m	€/m	€/m	
<b>Single components</b>							
	<b>MUTO Comfort L 80 side panel profile</b>						
	58 mm height, with all gaskets, for 8–13,5 mm glass thickness stock length 6000 mm in fixed length	€/Piece	115,00	130,00	115,00	158,00	158,00
36.271			23,50	27,50	23,50	33,00	33,00
36.274							
	<b>MUTO view protection profile</b>						
	for Comfort L, Premium XL and Premium Self-Closing, for side panel profile stock length 6000 mm in fixed length	€/Piece	68,00	78,50	68,00	94,00	94,00
36.800			14,50	16,50	14,50	19,50	19,50
36.801							
	<b>MUTO Filling profile</b>						
	for Comfort L, Premium XL and Premium Self-Closing stock length 6000 mm in fixed length	€/Piece	68,00	78,50	68,00	94,00	94,00
36.802			14,50	16,50	14,50	19,50	19,50
36.803							
	<b>MUTO Comfort L 80 end caps</b>						
	for installation at wall and ceiling	€/Piece	11,50	11,50	11,50		11,50
36.354							
	<b>MUTO Comfort L 80 end caps</b>						
	for side panel profile, 58 mm height	€/Piece	11,50	11,50	11,50		11,50
36.273							
	<b>MUTO Floor profile incl. 2 end caps</b>						
	for Comfort L, Premium XL and Premium Self-Closing for side panel fixing, complete with all gaskets, for 8–13,5 mm glass thickness stock length 6000 mm in fixed length	€/Piece	117,00	134,00	117,00	161,00	161,00
36.810			24,50	28,00	24,50	33,50	33,50
36.811							
	<b>MUTO end caps (2 pcs.)</b>						
	for Comfort L, Premium XL and Premium Self-Closing for floor profile - side panel fixing	€/Piece	8,00	8,00	8,00		8,00
36.812							

**Delivery status of side panel profile:**  
as part of complete sets = pre-drilled  
as single components = undrilled

\* With assemblies in special color (399) the end caps will be delivered in plastic anthracite-grey solid-colored.

**Timber door (28–50 mm) double-leaf with glass sidelights installation at ceiling (optional with Synchro)**

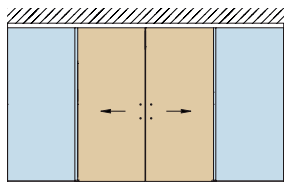

Base parts (000)	AL silver anod (150)	AL niro anod (157)	AL white p-coat (350)	AL special color anod (199)	AL special color p-coat (399)
					*

Art. No. Description €/Piece €/Piece €/Piece €/Piece €/Piece €/Piece

**Single components**

For Timber door application the adapter profile 36.261 / 36.262 will be necessitated

**MUTO Comfort L 80 Timber adapter set**

Profile 12.5 x 36 mm, incl. accessory set (floor guide for timber door panel) 1460 mm



36.261 50,00

36.262 in fixed length max. 2000 mm €/m 63,00

**MUTO Comfort L 80 accessories set**

consisting of:  
2 clamp carriers  
2 endstops  
1 floor guide

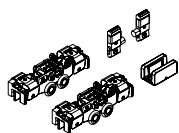

36.349 190,00 190,00

**MUTO Comfort L 80 track profile for installation at ceiling**

stock length 6000 mm

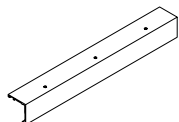

36.352 235,00 273,00 235,00 328,00 328,00

36.353 in fixed length €/m 49,00 €/m 57,00 €/m 49,00 €/m 68,00 €/m 68,00

**MUTO Comfort L 80 cover profile**

stock length 6000 mm

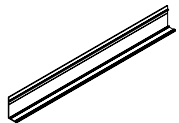

36.359 92,00 105,00 92,00 127,00 127,00

36.360 in fixed length €/m 19,00 €/m 21,50 €/m 19,00 €/m 26,50 €/m 26,50

**MUTO set of view protection brushes for Comfort M, L and Premium XL**

consisting of:  
1 view protection brush 8–10 mm glass thickness  
1 view protection brush 12–13.5 mm glass thickness



36.265 €/m 9,80

**Single components (optionally retrofittable)**

**MUTO Comfort L 80 DORMOTION unit, Version 2017**

for max. 80 kg, incl. starter  
min. panel width 660 mm  
max. panel width 2000 mm

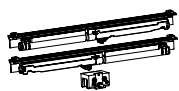

36.361 92,00

**MUTO Comfort L 80 Synchro-Set**

for max. 80 kg  
consisting of:  
1 elastic rope  
2 deflexion roller



36.357 257,00

\* With assemblies in special color (399) the end caps will be delivered in plastic anthracite-grey solid-colored.

## Timber door (28–50 mm) double-leaf with glass sidelights installation at ceiling (optional with Synchro)

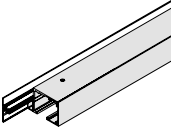
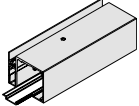
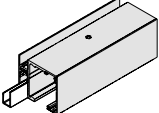
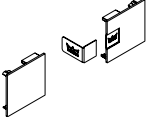
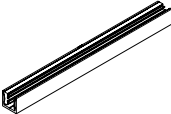
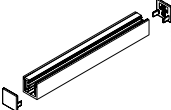
Art. No.	Description	AL silver anod (150)	AL niro anod (157)	AL white p-coat (350)	AL special color anod (199)	AL special color p-coat (399) *	
		€/m	€/m	€/m	€/m	€/m	
<b>Single components</b>							
	<b>MUTO Comfort L 80 side panel profile</b> 58 mm height, with all gaskets, for 8–13,5 mm glass thickness stock length 6000 mm in fixed length	€/Piece	115,00 23,50	130,00 27,50	115,00 23,50	158,00 33,00	158,00 33,00
	<b>MUTO view protection profile</b> for Comfort L, Premium XL and Premium Self-Closing, for side panel profile stock length 6000 mm in fixed length	€/Piece	68,00 14,50	78,50 16,50	68,00 14,50	94,00 19,50	94,00 19,50
	<b>MUTO Filling profile</b> for Comfort L, Premium XL and Premium Self-Closing stock length 6000 mm in fixed length	€/Piece	68,00 14,50	78,50 16,50	68,00 14,50	94,00 19,50	94,00 19,50
	<b>MUTO Comfort L 80 end caps</b> for installation at wall and ceiling	€/Piece	11,50	11,50	11,50		11,50
	<b>MUTO Comfort L 80 end caps</b> for side panel profile, 58 mm height	€/Piece	11,50	11,50	11,50		11,50
	<b>MUTO Floor profile incl. 2 end caps</b> for Comfort L, Premium XL and Premium Self-Closing for side panel fixing, complete with all gaskets, for 8–13,5 mm glass thickness stock length 6000 mm in fixed length	€/Piece	117,00 24,50	134,00 28,00	117,00 24,50	161,00 33,50	161,00 33,50
	<b>MUTO end caps (2 pcs.)</b> for Comfort L, Premium XL and Premium Self-Closing for floor profile - side panel fixing	€/Piece	8,00	8,00	8,00		8,00

**Delivery status of side panel profile:**  
as part of complete sets = pre-drilled  
as single components = undrilled

\* With assemblies in special color (399) the end caps will be delivered in plastic anthracite-grey solid-colored.

Timber door (28–50 mm) single-leaf with glass overpanel and glass sidelights

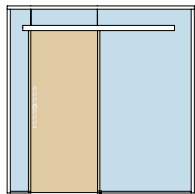

AL silver anod (150)	AL niro anod (157)	AL white p-coat (350)	AL special color anod (199)	AL special color p-coat (399)
				*

Art. No.	Description	€/Piece	€/Piece	€/Piece	€/Piece	€/Piece
----------	-------------	---------	---------	---------	---------	---------

**Complete sets (optional with DORMOTION)  
For Timber door application the adapter profile  
36.261 / 36.262 will be necessitated**

**Defined lengths**

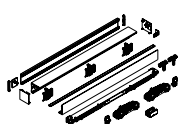

**36.304 MUTO Comfort L 80  
for 1050 mm clear opening width / 1110 mm panel width**  
consisting of:  
1 track profile 2287 mm  
1 cover profile 2287 mm  
1 counter profile 2287 mm  
2 clamp carriers  
(for 8–13.5 mm glass thickness)  
with anti-jump mechanism  
2 endstops with safety catch and anti jump device  
1 floor guide  
2 end caps  
incl. view protection brushes 2287 mm

482,00	516,00	482,00	568,00	568,00
--------	--------	--------	--------	--------

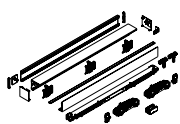

**36.305 MUTO Comfort L 80  
for 1250 mm clear opening width / 1310 mm panel width**  
consisting of:  
1 track profile 2687 mm  
1 cover profile 2687 mm  
1 counter profile 2687 mm  
2 clamp carriers  
(for 8–13.5 mm glass thickness)  
with anti-jump mechanism  
2 endstops with safety catch and anti jump device  
1 floor guide  
2 end caps  
incl. view protection brushes 2687 mm

602,00	660,00	602,00	727,00	727,00
--------	--------	--------	--------	--------

**Individual lengths**

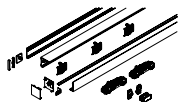

**36.322 MUTO Comfort L 80  
for max. 1940 mm clear opening width /  
max. 2000 mm panel width**  
consisting of:  
1 track profile max. 4067 mm  
1 cover profile max. 4067 mm  
1 counter profile max. 4067 mm  
2 clamp carriers  
(for 8–13.5 mm glass thickness)  
with anti-jump mechanism  
2 endstops with safety catch and anti jump device  
1 floor guide  
2 end caps  
incl. view protection brushes max. 4067 mm

Basic 2287 mm	482,00	516,00	482,00	568,00	568,00
Surcharge per mm	0,30	0,30	0,30	0,30	0,30
Max. 4067 mm					

\* With assemblies in special color (399) the end caps will be delivered in plastic anthracite-grey solid-colored.



**Timber door (28–50 mm) double-leaf with glass overpanels and glass sidelights (optional with Synchro)**

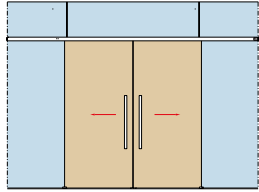

AL silver anod (150)	AL niro anod (157)	AL white p-coat (350)	AL special color anod (199)	AL special color p-coat (399)
----------------------	--------------------	-----------------------	-----------------------------	-------------------------------

\*

Art. No. Description €/Piece €/Piece €/Piece €/Piece €/Piece

**Complete sets (inclusive DORMOTION, optional with Synchro)**  
**For Timber door application the adapter profile**  
**36.261 / 36.262 will be necessitated**

**Individual lengths**

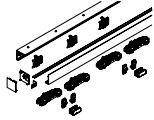

**36.325 MUTO Comfort L 80 for two panels with max. 2446 clear opening width / with a maximum panel width of 1250 mm each**

- consisting of:
- 1 track profile max. 5012 mm
  - 1 cover profile max. 5012 mm
  - 1 counter profile max. 5012 mm
  - 4 clamp carriers (for 8–13.5 mm glass thickness) with anti-jump mechanism
  - 4 endstops with safety catch and anti jump device
  - 2 floor guides
  - 2 end caps
  - incl. view protection brushes max. 5012 mm

Basic 4574 mm  
 Surcharge per mm  
 Max. 5012 mm

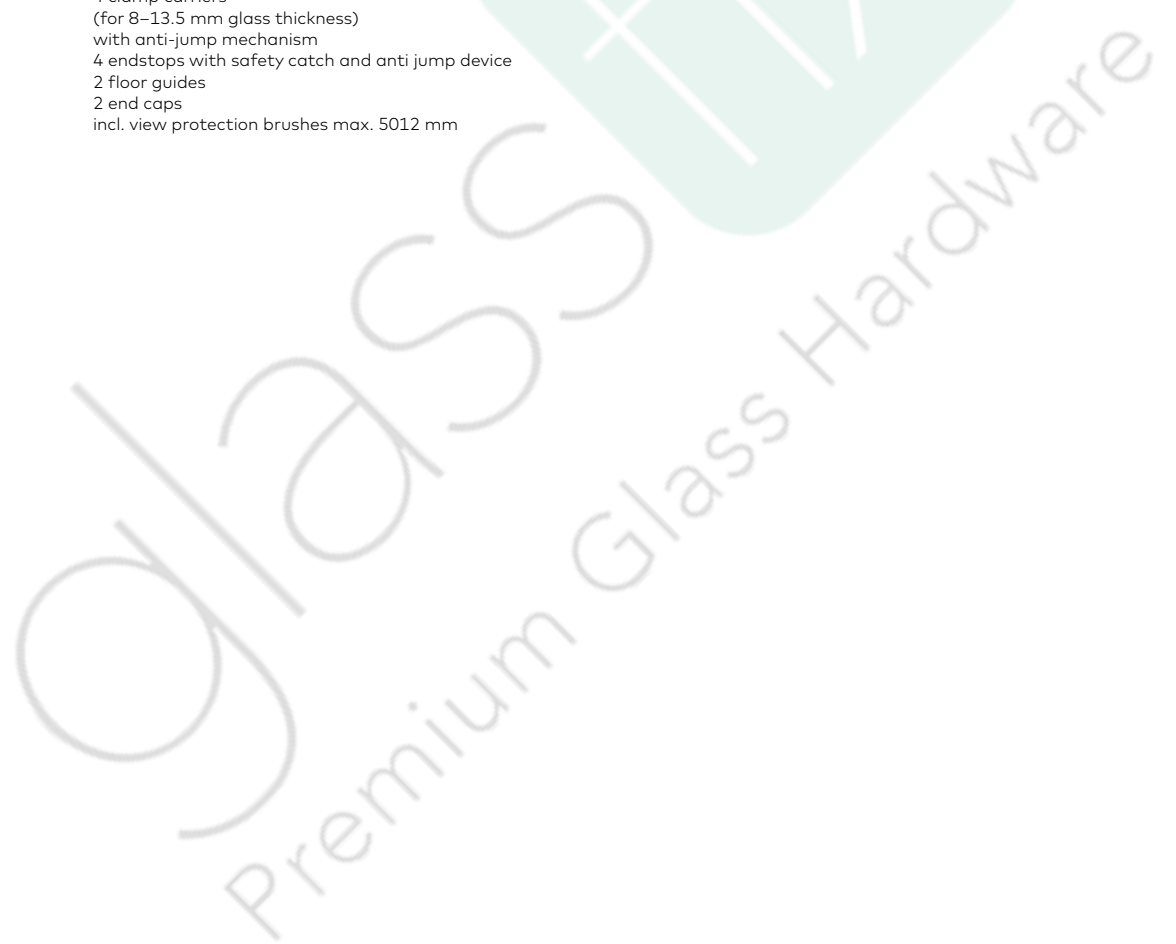

963,00	1032,00	963,00	1135,00	1135,00
0,30	0,30	0,30	0,30	0,30



\* With assemblies in special color (399) the end caps will be delivered in plastic anthracite-grey solid-colored.

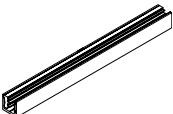
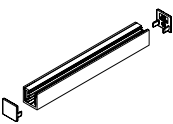
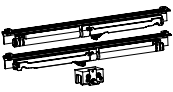

## Timber door (28–50 mm) double-leaf with glass overpanels and glass sidelights (optional with Synchro)

Art. No.	Description	Base parts (000)	AL silver anod (150)	AL niro anod (157)	AL white p-coat (350)	AL special color anod (199)	AL special color p-coat (399)	*
		€/Piece	€/Piece	€/Piece	€/Piece	€/Piece	€/Piece	€/Piece
<b>Single components</b>								
	<b>36.261</b> <b>MUTO Comfort L 80 Timber adapter set</b> Profile 12.5 x 36 mm, incl. accessory set (floor guide for timber door panel) 1460 mm	50,00						
	<b>36.262</b> in fixed length max. 2000 mm	€/m	63,00					
	<b>36.810</b> <b>MUTO Floor profile</b> <b>incl. 2 end caps</b> for Comfort L, Premium XL and Premium Self-Closing for side panel fixing, complete with all gaskets, for 8–13,5 mm glass thickness stock length 6000 mm	117,00	134,00	117,00	161,00	161,00		
	<b>36.811</b> in fixed length	€/m	24,50	28,00	24,50	33,50	33,50	
	<b>36.812</b> <b>MUTO end caps (2 pcs.)</b> for Comfort L, Premium XL and Premium Self-Closing for floor profile - side panel fixing	8,00	8,00	8,00				
<b>Single components (optionally retrofittable)</b>								
	<b>36.361</b> <b>MUTO Comfort L 80 DORMOTION unit, Version 2017</b> for max. 80 kg, incl. starter min. panel width 660 mm max. panel width 2000 mm	92,00						
	<b>36.357</b> <b>MUTO Comfort L 80 Synchro-Set</b> for max. 80 kg consisting of: 1 elastic rope 2 deflexion roller	257,00						

\* With assemblies in special color (399) the end caps will be delivered in plastic anthracite-grey solid-colored.

Notes

Sliding



# MUTO Premium XL 80 / 150



Technical data	
Glass	TSG, LSG (from 2 x TSG)
glass thickness	8-13,5 mm
Max. door weight	80 kg/150 kg
Applications	single-leaf, double-leaf, (glass or timber leaves), glass sidelights, at glass
Material	Aluminium
Finishes	Anodized- and RAL-Colors (coated)
Kind of installation	Wall, ceiling and at glass
Specials	DORMOTION integrated locking mechanism and status indicator are optionally retrofittable For double leaf assemblies Synchro is optionally retrofittable Tested acc. DIN EN 1527 Height readjustable without dismantling +/-5 mm

Example view for MUTO Premium XL 80/150 installation at wall

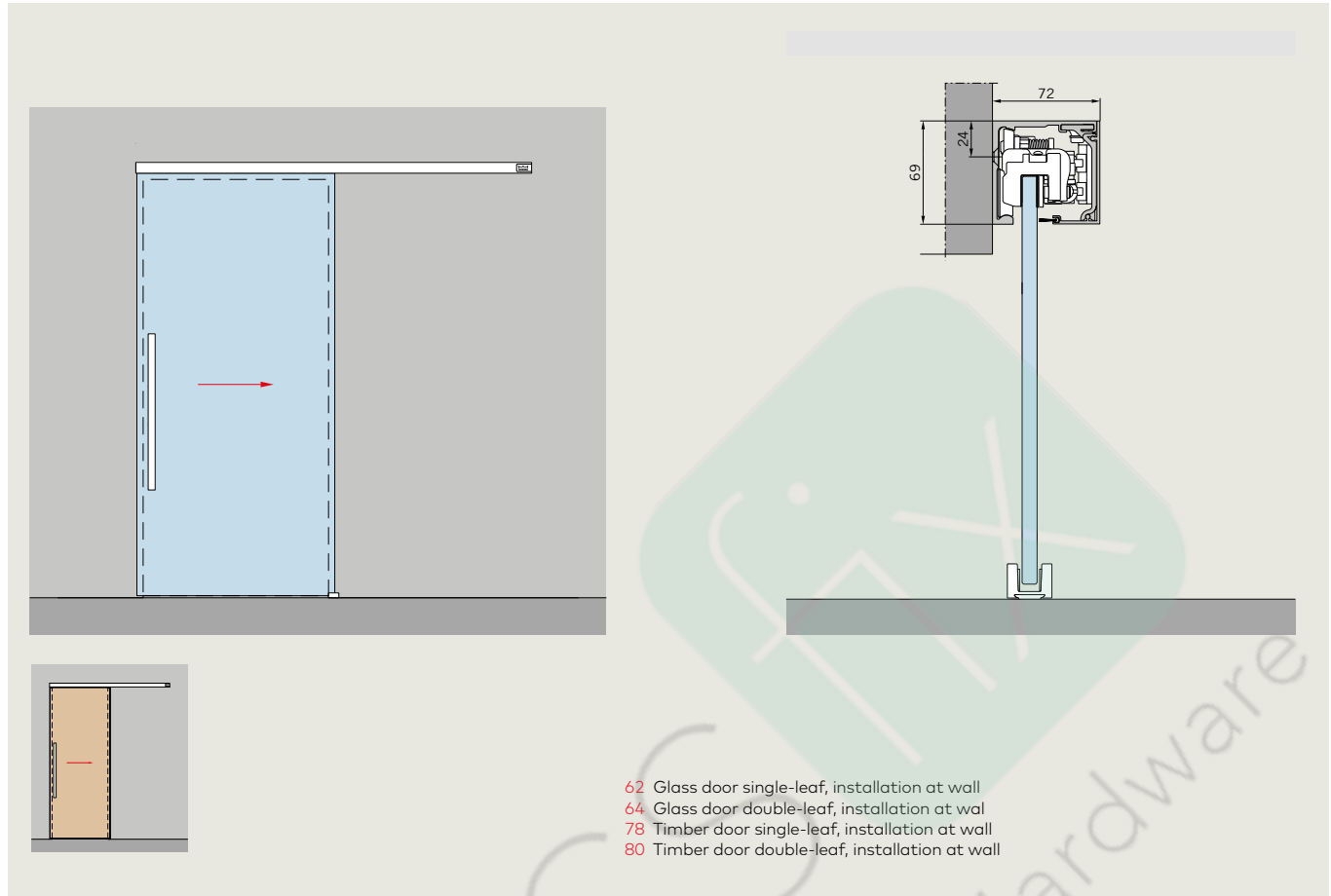

Example view for MUTO Premium XL 80/150 Installation at ceiling

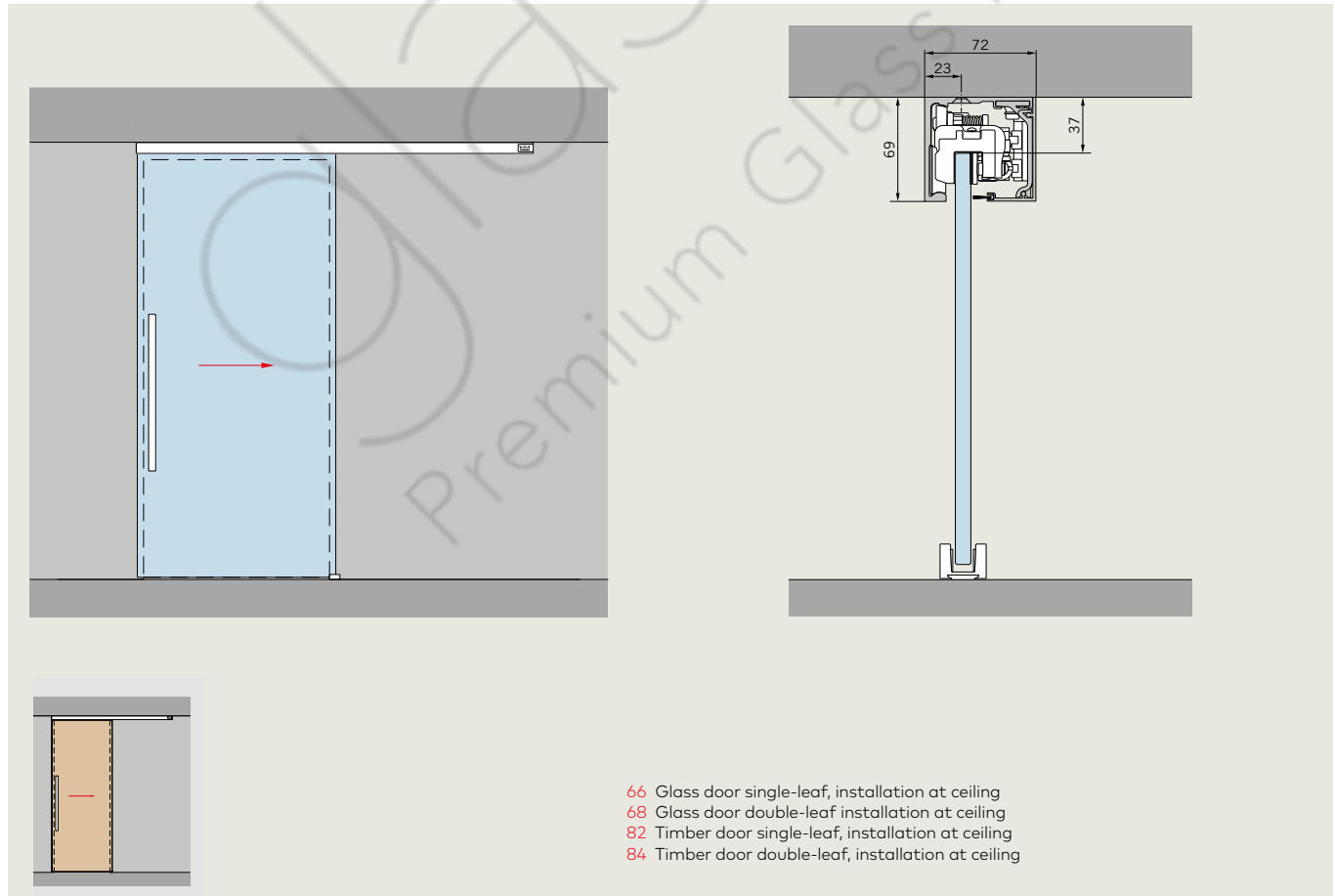

Example view for MUTO Premium XL 80/150 with glass sidelight/s

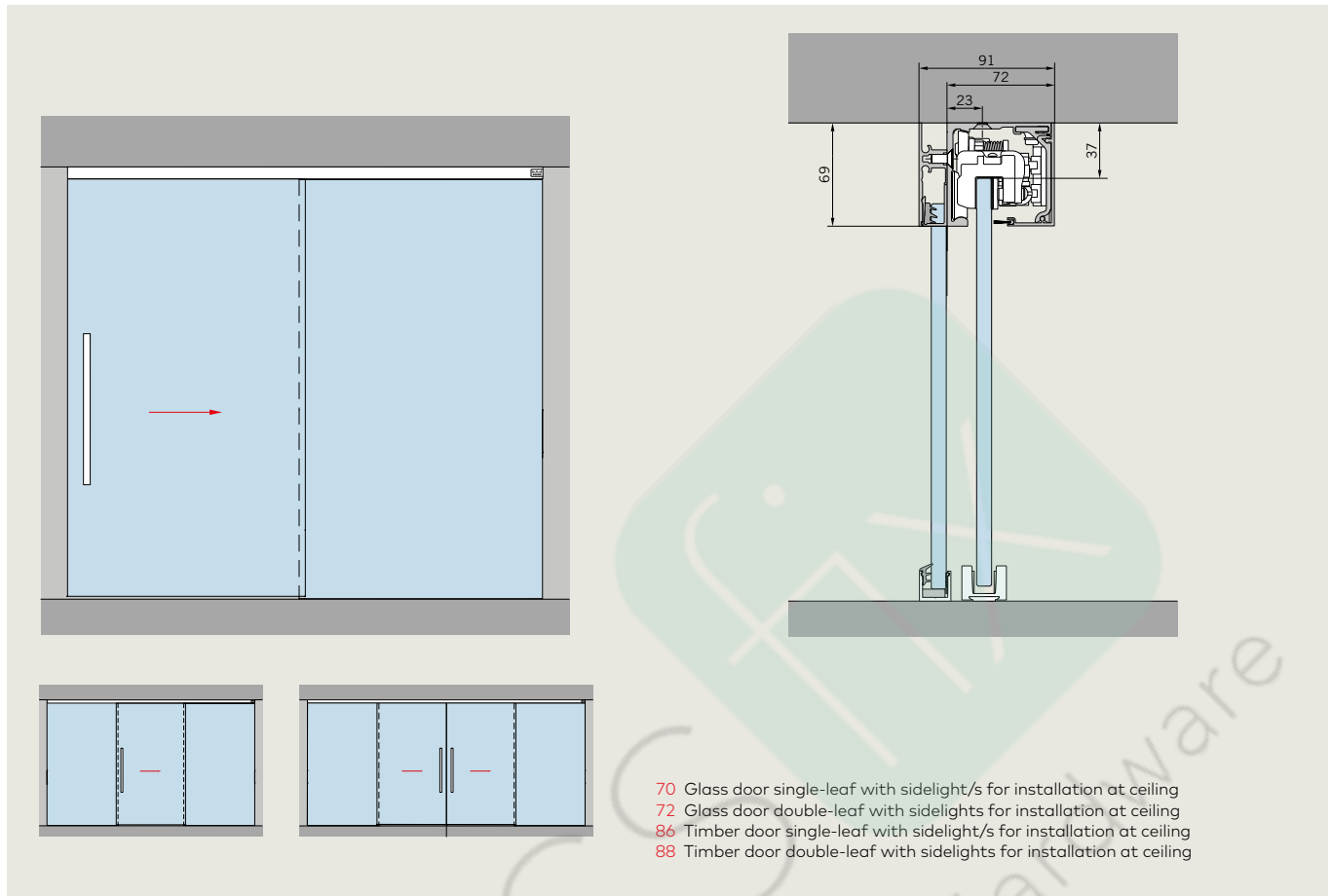

- 70 Glass door single-leaf with sidelight/s for installation at ceiling
- 72 Glass door double-leaf with sidelights for installation at ceiling
- 86 Timber door single-leaf with sidelight/s for installation at ceiling
- 88 Timber door double-leaf with sidelights for installation at ceiling

Sliding

Example view for MUTO Premium XL 80/150 with glass overpanel and glass sidelights

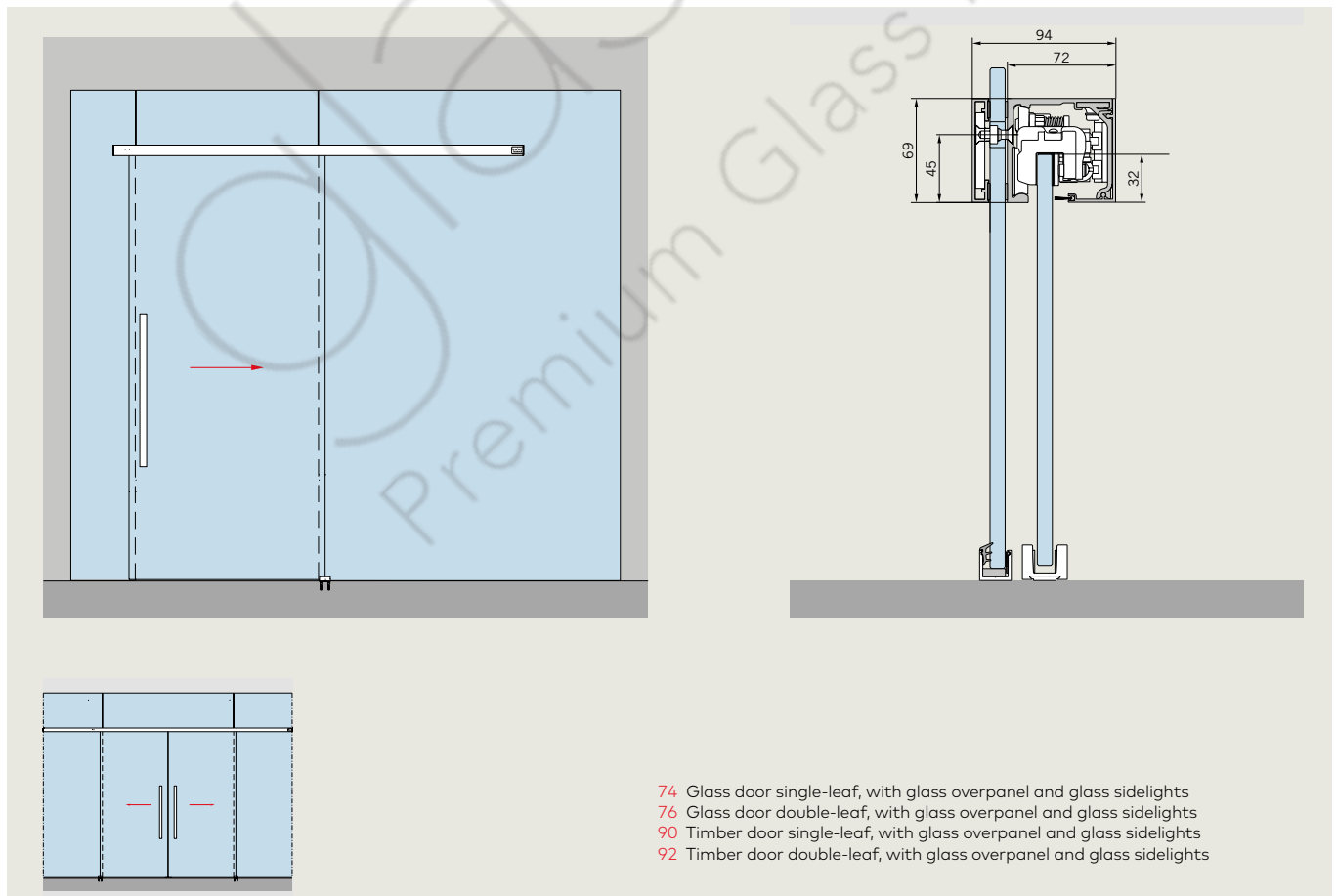

- 74 Glass door single-leaf, with glass overpanel and glass sidelights
- 76 Glass door double-leaf, with glass overpanel and glass sidelights
- 90 Timber door single-leaf, with glass overpanel and glass sidelights
- 92 Timber door double-leaf, with glass overpanel and glass sidelights

Glass door (8–13,5 mm) single-leaf, installation at wall

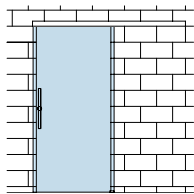

AL silver anod (150)	AL niro anod (157)	AL white p-coat (350)	AL special color anod (199)	AL special color p-coat (399)
				*

Art. No.	Description	€/Piece	€/Piece	€/Piece	€/Piece	€/Piece
----------	-------------	---------	---------	---------	---------	---------

Complete sets (inclusive DORMOTION)

Defined lengths

MUTO Premium XL 80/150

consisting of:  
 1 track profile  
 1 cover profile  
 2 clamp carriers  
 (for 8–13.5 mm glass thickness)  
 with anti-jump mechanism  
 2 endstops with safety catch and anti jump device  
 1 floor guide  
 2 end caps  
 incl. brush profile  
 1 DORMOTION unit

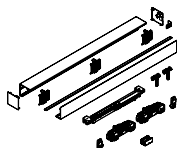

<b>36.500</b>	<b>max. 80 kg, incl. DORMOTION XL – 80</b>	900 mm panel width/1780 mm profile length	596,00	642,00	596,00	771,00	771,00
<b>36.501</b>		1200 mm panel width/2380 mm profile length	679,00	739,00	679,00	886,00	886,00
<b>36.502</b>		1450 mm panel width/2880 mm profile length	747,00	818,00	747,00	982,00	982,00

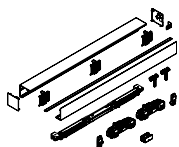

<b>36.509</b>	<b>max. 150 kg, incl. DORMOTION XL – 150</b>	1250 mm panel width/2480 mm profile length	734,00	780,00	734,00	936,00	936,00
<b>36.510</b>		1450 mm panel width/2880 mm profile length	788,00	844,00	788,00	1012,00	1012,00

Individual lengths

MUTO Premium XL 80/150

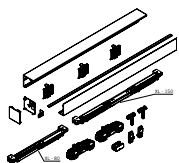

consisting of:  
 1 track profile max. 5000 mm  
 1 cover profile max. 5000 mm  
 2 clamp carriers  
 (for 8–13.5 mm glass thickness)  
 with anti-jump mechanism  
 2 endstops with safety catch and anti jump device  
 1 floor guide  
 2 end caps  
 incl. view protection brushes max. 5000 mm  
 1 DORMOTION unit



<b>36.520</b>	<b>max. 80 kg, incl. DORMOTION XL – 80</b>	Basic 1780 mm panel width min. 810/max. 2500 mm	596,00 0,30	642,00 0,30	596,00 0,30	771,00 0,40	771,00 0,40
<b>36.521</b>	<b>max. 150 kg, incl. DORMOTION XL – 150</b>	Basic 2480 mm panel width min. 1020/max. 2500 mm	734,00 0,30	780,00 0,30	734,00 0,30	936,00 0,40	936,00 0,40

\* With assemblies in special color (399) the end caps will be delivered in plastic anthracite-grey solid-colored.

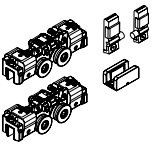
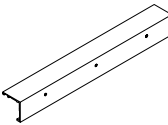
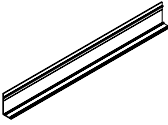
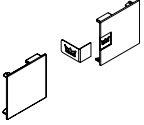
## Glass door (8–13,5 mm) single-leaf, installation at wall

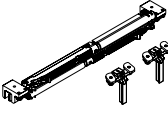
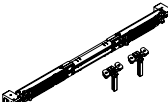
Art. No.	Description	Base parts (000)	AL silver anod (150)	AL niro anod (157)	AL white p-coat (350)	AL special color anod (199)	AL special color p-coat (399)
		€/Piece	€/Piece	€/Piece	€/Piece	€/Piece	€/Piece
<b>Single components</b>							
	<b>36.550 MUTO Premium XL 80/150 accessories set</b> consisting of: 2 clamp carriers 2 endstops 1 floor guide		252,00	252,00			
	<b>36.552 MUTO Premium XL 80/150 track profile for installation at wall</b> stock length 6000 mm	329,00	383,00	329,00	459,00	459,00	
	<b>36.553</b> in fixed length	€/m	€/m	€/m	€/m	€/m	
		68,50	79,50	68,50	95,50	95,50	
	<b>36.566 MUTO Premium XL 80/150 cover profile</b> stock length 6000 mm	128,00	148,00	128,00	178,00	178,00	
	<b>36.567</b> in fixed length	€/m	€/m	€/m	€/m	€/m	
		27,00	30,50	27,00	36,50	36,50	
	<b>36.556 MUTO Premium XL 80/150 end caps</b> for installation at wall and ceiling		11,50	11,50	11,50		11,50
	<b>36.265 MUTO set of view protection brushes for Comfort M, L and Premium XL</b> consisting of: 1 view protection brush 8–10 mm glass thickness 1 view protection brush 12–13.5 mm glass thickness	€/m					
		9,80					
<b>Single components (optionally retrofittable)</b>							
	<b>36.557 MUTO Premium XL 80 DORMOTION unit</b> for max. 80 kg, incl. starter min. panel width 810 mm max. panel width 2500 mm		172,00				
	<b>36.558 MUTO Premium XL 150 DORMOTION unit</b> for max. 150 kg, incl. starter min. panel width 1020 mm max. panel width 2500 mm		218,00				

\* With assemblies in special color (399) the end caps will be delivered in plastic anthracite-grey solid-colored.

LSG accessories, Status-indicator and integrated locking mechanism on pages 130–131.

**Glass door (8 – 13.5 mm) double-leaf, for installation at wall (optional with Synchro)**

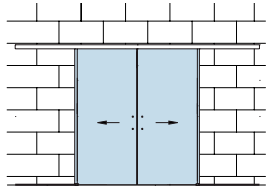

AL silver anod (150)	AL niro anod (157)	AL white p-coat (350)	AL special color anod (199)	AL special color p-coat (399)
				*

Art. No.	Description	€/Piece	€/Piece	€/Piece	€/Piece	€/Piece
----------	-------------	---------	---------	---------	---------	---------

**Complete sets (inclusive DORMOTION, optional with Synchro)**

**Individual lengths**

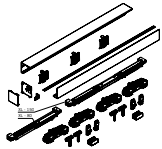

**MUTO Premium XL 80/150**

**for two panels**

consisting of:





- 1 track profile max. 5880 mm
- 1 cover profile max. 5880 mm
- 4 clamp carriers (for 8–13.5 mm glass thickness) with anti-jump mechanism
- 4 endstops with safety catch and anti jump device
- 2 floor guides
- 2 end caps
- incl. view protection brushes max. 5880 mm
- 2 DORMOTION units

<b>36.526</b>	<b>max. 80 kg</b> panel width: min. 810 mm, max. 1470 mm	Basic 3560 mm Surcharge per mm Max. 5880 mm	<b>1193,00</b>	<b>1284,00</b>	<b>1193,00</b>	<b>1541,00</b>	<b>1541,00</b>
			<b>0,30</b>	<b>0,30</b>	<b>0,30</b>	<b>0,40</b>	<b>0,40</b>
<b>36.527</b>	<b>max. 150 kg</b> panel width: min. 1020 mm, max. 1470 mm	Basic 4960 mm Surcharge per mm Max. 5880 mm	<b>1468,00</b>	<b>1559,00</b>	<b>1468,00</b>	<b>1871,00</b>	<b>1871,00</b>
			<b>0,30</b>	<b>0,30</b>	<b>0,30</b>	<b>0,40</b>	<b>0,40</b>

\* With assemblies in special color (399) the end caps will be delivered in plastic anthracite-grey solid-colored.

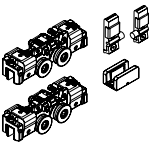
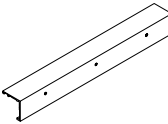
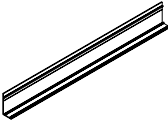
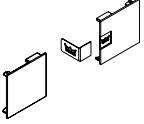

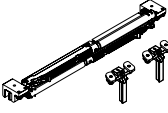
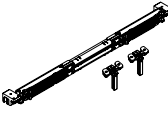
## Glass door (8 – 13.5 mm) double-leaf, for installation at wall (optional with Synchro)

Art. No.	Description	Base parts (000)	AL silver anod (150)	AL niro anod (157)	AL white p-coat (350)	AL special color anod (199)	AL special color p-coat (399)
		€/Piece	€/Piece	€/Piece	€/Piece	€/Piece	€/Piece
<b>Single components</b>							
	<b>36.550 MUTO Premium XL 80/150 accessories set</b> consisting of: 2 clamp carriers 2 endstops 1 floor guide	252,00	252,00				
	<b>36.552 MUTO Premium XL 80/150 track profile for installation at wall</b> stock length 6000 mm	329,00 €/m	383,00 €/m	329,00 €/m	459,00 €/m	459,00 €/m	
	<b>36.553</b> in fixed length	68,50	79,50	68,50	95,50	95,50	
	<b>36.566 MUTO Premium XL 80/150 cover profile</b> stock length 6000 mm	128,00 €/m	148,00 €/m	128,00 €/m	178,00 €/m	178,00 €/m	
	<b>36.567</b> in fixed length	27,00	30,50	27,00	36,50	36,50	
	<b>36.556 MUTO Premium XL 80/150 end caps</b> for installation at wall and ceiling	11,50	11,50	11,50			11,50
	<b>36.265 MUTO set of view protection brushes for Comfort M, L and Premium XL</b> consisting of: 1 view protection brush 8–10 mm glass thickness 1 view protection brush 12–13.5 mm glass thickness	9,80 €/m					
<b>Single components (optionally retrofittable)</b>							
	<b>36.557 MUTO Premium XL 80 DORMOTION unit</b> for max. 80 kg, incl. starter min. panel width 810 mm max. panel width 2500 mm	172,00					
	<b>36.558 MUTO Premium XL 150 DORMOTION unit</b> for max. 150 kg, incl. starter min. panel width 1020 mm max. panel width 2500 mm	218,00					
	<b>36.560 MUTO Premium XL 80/150 Synchro-Set</b> for max. 80 kg consisting of: 1 elastic rope, 2 deflexion roller	302,00					

\* With assemblies in special color (399) the end caps will be delivered in plastic anthracite-grey solid-colored.

LSG accessories, Status-indicator and integrated locking mechanism on pages 130–131.

Glass door (8–13,5 mm) single-leaf for installation at ceiling

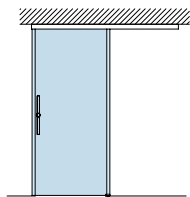

AL silver anod (150)	AL niro anod (157)	AL white p-coat (350)	AL special color anod (199)	AL special color p-coat (399)
				*

Art. No.	Description	€/Piece	€/Piece	€/Piece	€/Piece	€/Piece
----------	-------------	---------	---------	---------	---------	---------

Complete sets (inclusive DORMOTION)

Defined lengths

MUTO Premium XL 80/150

consisting of:  
 1 track profile  
 1 cover profile  
 2 clamp carriers  
 (for 8–13.5 mm glass thickness)  
 with anti-jump mechanism  
 2 endstops with safety catch and anti jump device  
 1 floor guide  
 2 end caps  
 incl. brush profile  
 1 DORMOTION unit

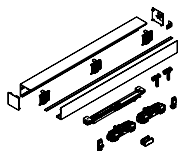

<b>36.503</b>	<b>max. 80 kg, incl. DORMOTION XL – 80</b> 900 mm panel width/1780 mm profile length	596,00	642,00	596,00	771,00	771,00
<b>36.504</b>	1200 mm panel width/2380 mm profile length	679,00	739,00	679,00	886,00	886,00
<b>36.505</b>	1450 mm panel width/2880 mm profile length	747,00	818,00	747,00	982,00	982,00

max. 150 kg, incl. DORMOTION XL – 150

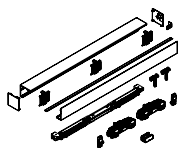

<b>36.511</b>	1250 mm panel width/2480 mm profile length	734,00	780,00	734,00	936,00	936,00
<b>36.512</b>	1450 mm panel width/2880 mm profile length	788,00	844,00	788,00	1012,00	1012,00

Individual lengths

MUTO Premium XL 80/150

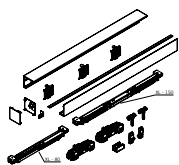

consisting of:  
 1 track profile max. 5000 mm  
 1 cover profile max. 5000 mm  
 2 clamp carriers  
 (for 8–13.5 mm glass thickness)  
 with anti-jump mechanism  
 2 endstops with safety catch and anti jump device  
 1 floor guide  
 2 end caps  
 incl. view protection brushes max. 5000 mm  
 1 DORMOTION unit



<b>36.522</b>	<b>max. 80 kg, inkl. DORMOTION XL – 80</b> panel width min. 810/max. 2500 mm	Basic 1780 mm Surcharge per mm Max. 5000 mm	596,00 0,30	642,00 0,30	596,00 0,30	771,00 0,40	771,00 0,40
<b>36.523</b>	<b>max. 150 kg, inkl. DORMOTION XL – 150</b> panel width min. 1020/max. 2500 mm	Basic 2480 mm Surcharge per mm Max. 5000 mm	734,00 0,30	780,00 0,30	734,00 0,30	936,00 0,40	936,00 0,40

\* With assemblies in special color (399) the end caps will be delivered in plastic anthracite-grey solid-colored.

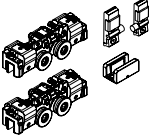
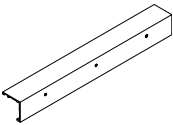
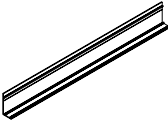
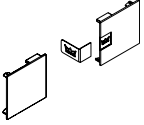
## Glass door (8–13,5 mm) single-leaf for installation at ceiling

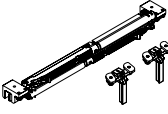
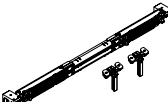
Art. No.	Description	Base parts (000)	AL silver anod (150)	AL niro anod (157)	AL white p-coat (350)	AL special color anod (199)	AL special color p-coat (399)	€ / Piece	€ / Piece	€ / Piece	€ / Piece	€ / Piece	€ / Piece
<b>Single components</b>													
	<b>36.550</b>	<b>MUTO Premium XL 80/150 accessories set</b> consisting of: 2 clamp carriers 2 endstops 1 floor guide						252,00	252,00				
	<b>36.554</b>	<b>MUTO Premium XL 80/150 track profile for installation at ceiling</b> stock length 6000 mm						329,00	383,00	329,00	459,00	459,00	
	<b>36.555</b>	in fixed length						€ / m	€ / m	€ / m	€ / m	€ / m	
								68,50	79,50	68,50	95,50	95,50	
	<b>36.566</b>	<b>MUTO Premium XL 80/150 cover profile</b> stock length 6000 mm						128,00	148,00	128,00	178,00	178,00	
	<b>36.567</b>	in fixed length						€ / m	€ / m	€ / m	€ / m	€ / m	
								27,00	30,50	27,00	36,50	36,50	
	<b>36.556</b>	<b>MUTO Premium XL 80/150 end caps</b> for installation at wall and ceiling						11,50	11,50	11,50			11,50
	<b>36.265</b>	<b>MUTO set of view protection brushes for Comfort M, L and Premium XL</b> consisting of: 1 view protection brush 8–10 mm glass thickness 1 view protection brush 12–13.5 mm glass thickness						€ / m	9,80				
<b>Single components (optionally retrofittable)</b>													
	<b>36.557</b>	<b>MUTO Premium XL 80 DORMOTION unit</b> for max. 80 kg, incl. starter min. panel width 810 mm max. panel width 2500 mm							172,00				
	<b>36.558</b>	<b>MUTO Premium XL 150 DORMOTION unit</b> for max. 150 kg, incl. starter min. panel width 1020 mm max. panel width 2500 mm							218,00				

\* With assemblies in special color (399) the end caps will be delivered in plastic anthracite-grey solid-colored.

LSG accessories, Status-indicator and integrated locking mechanism on pages 130–131.

**Glass door (8–13,5 mm) double-leaf for installation at ceiling (optional with Synchro)**

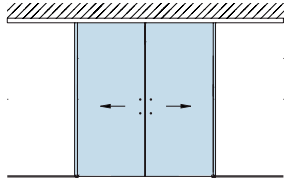

AL silver anod (150)	AL niro anod (157)	AL white p-coat (350)	AL special color anod (199)	AL special color p-coat (399)
				*

Art. No.	Description	€/Piece	€/Piece	€/Piece	€/Piece	€/Piece
----------	-------------	---------	---------	---------	---------	---------

**Complete sets (inclusive DORMOTION, optional with Synchro)**

**Individual lengths**

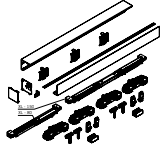

**MUTO Premium XL 80/150**

**for two panels**





consisting of:

- 1 track profile max. 5880 mm
- 1 cover profile max. 5880 mm
- 4 clamp carriers (for 8–13.5 mm glass thickness) with anti-jump mechanism
- 4 endstops with safety catch and anti jump device
- 2 floor guides
- 2 end caps
- incl. view protection brushes max. 5880 mm
- 2 DORMOTION units

<b>36.528</b>	<b>max. 80 kg</b> panel width: min. 810 mm, max. 1470 mm	Basic 3560 mm Surcharge per mm Max. 5880 mm	<b>1193,00</b>	<b>1284,00</b>	<b>1193,00</b>	<b>1541,00</b>	<b>1541,00</b>
			<b>0,30</b>	<b>0,30</b>	<b>0,30</b>	<b>0,40</b>	<b>0,40</b>
<b>36.529</b>	<b>max. 150 kg</b> panel width: min. 1020 mm, max. 1470 mm	Basic 4960 mm Surcharge per mm Max. 5880 mm	<b>1468,00</b>	<b>1559,00</b>	<b>1468,00</b>	<b>1871,00</b>	<b>1871,00</b>
			<b>0,30</b>	<b>0,30</b>	<b>0,30</b>	<b>0,40</b>	<b>0,40</b>

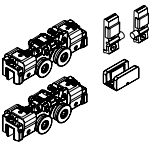
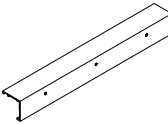
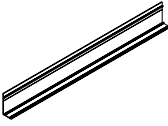
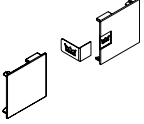
\* With assemblies in special color (399) the end caps will be delivered in plastic anthracite-grey solid-colored.

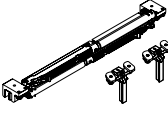
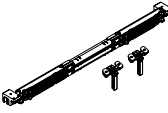
## Glass door (8–13,5 mm) double-leaf for installation at ceiling (optional with Synchro)

Art. No.	Description	Base parts (000)	AL silver anod (150)	AL niro anod (157)	AL white p-coat (350)	AL special color anod (199)	AL special color p-coat (399)
		€/Piece	€/Piece	€/Piece	€/Piece	€/Piece	€/Piece
<b>Single components</b>							
	<b>36.550 MUTO Premium XL 80/150 accessories set</b> consisting of: 2 clamp carriers 2 endstops 1 floor guide		252,00	252,00			
	<b>36.554 MUTO Premium XL 80/150 track profile for installation at ceiling</b> stock length 6000 mm		329,00	383,00	329,00	459,00	459,00
	<b>36.555</b> in fixed length		€/m 68,50	€/m 79,50	€/m 68,50	€/m 95,50	€/m 95,50
	<b>36.566 MUTO Premium XL 80/150 cover profile</b> stock length 6000 mm		128,00	148,00	128,00	178,00	178,00
	<b>36.567</b> in fixed length		€/m 27,00	€/m 30,50	€/m 27,00	€/m 36,50	€/m 36,50
	<b>36.556 MUTO Premium XL 80/150 end caps</b> for installation at wall and ceiling		11,50	11,50	11,50		11,50
	<b>36.265 MUTO set of view protection brushes for Comfort M, L and Premium XL</b> consisting of: 1 view protection brush 8–10 mm glass thickness 1 view protection brush 12–13.5 mm glass thickness		€/m 9,80				
<b>Single components (optionally retrofittable)</b>							
	<b>36.557 MUTO Premium XL 80 DORMOTION unit</b> for max. 80 kg, incl. starter min. panel width 810 mm max. panel width 2500 mm		172,00				
	<b>36.558 MUTO Premium XL 150 DORMOTION unit</b> for max. 150 kg, incl. starter min. panel width 1020 mm max. panel width 2500 mm		218,00				
	<b>36.560 MUTO Premium XL 80/150 Synchro-Set</b> for max. 80 kg consisting of: 1 elastic rope, 2 deflexion roller		302,00				

\* With assemblies in special color (399) the end caps will be delivered in plastic anthracite-grey solid-colored.

LSG accessories, Status-indicator and integrated locking mechanism on pages 130–131.

**Glass door (8–13,5 mm) single-leaf with glass sidelight/s installation at ceiling**

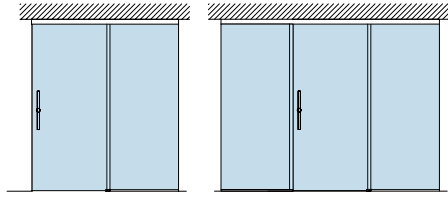

Base parts (000)	AL silver anod (150)	AL niro anod (157)	AL white p-coat (350)	AL special color anod (199)	AL special color p-coat (399)
					*

Art. No.	Description	€/Piece	€/Piece	€/Piece	€/Piece	€/Piece
----------	-------------	---------	---------	---------	---------	---------

**Complete sets**

**MUTO Premium XL 80/150**

consisting of:  
 1 track profile max. 5000 mm for sidelight connection  
 1 cover profile max. 5000 mm  
 1 sidelight profile max. 5000 mm  
 1 view protection profile depending on panel and sidelight  
 1 filling profile depending on panel and sidelight  
 2 clamp carriers  
 (for 8–13.5 mm glass thickness)  
 with anti-jump mechanism  
 2 endstops with safety catch and anti jump device  
 1 floor guide  
 2 end caps  
 incl. view protection brushes max. 5000 mm  
 1 DORMOTION unit

<b>36.515</b>	<b>max. 80 kg, incl. DORMOTION XL – 80</b> panel width min. 810/max. 2500 mm	Basic 1780 mm Surcharge per mm Max. 5000 mm	692,00 0,40	750,00 0,40	692,00 0,40	899,00 0,40	899,00 0,40
<b>36.516</b>	<b>max. 150 kg, incl. DORMOTION XL – 150</b> panel width min. 1020/max. 2500 mm	Basic 2480 mm Surcharge per mm Max. 5000 mm	864,00 0,40	927,00 0,40	864,00 0,40	1109,00 0,40	1109,00 0,40

**Single components**

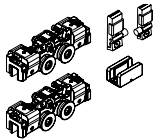

<b>36.550</b>	<b>MUTO Premium XL 80/150 accessories set</b> consisting of: 2 clamp carriers 2 endstops 1 floor guide		252,00	252,00			
---------------	--	--	--------	--------	--	--	--

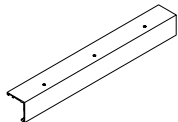

<b>36.554</b>	<b>MUTO Premium XL 80/150 track profile for installation at ceiling</b> stock length 6000 mm		329,00 €/m	383,00 €/m	329,00 €/m	459,00 €/m	459,00 €/m
<b>36.555</b>	in fixed length		68,50	79,50	68,50	95,50	95,50

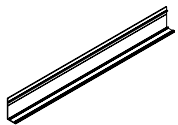

<b>36.566</b>	<b>MUTO Premium XL 80/150 cover profile</b> stock length 6000 mm		128,00 €/m	148,00 €/m	128,00 €/m	178,00 €/m	178,00 €/m
<b>36.567</b>	in fixed length		27,00	30,50	27,00	36,50	36,50



<b>36.265</b>	<b>MUTO set of view protection brushes for Comfort M, L and Premium XL</b> consisting of: 1 view protection brush 8–10 mm glass thickness 1 view protection brush 12–13.5 mm glass thickness		€/m 9,80				
---------------	---	--	-------------	--	--	--	--

**Single components (optionally retrofittable)**

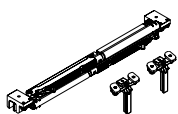

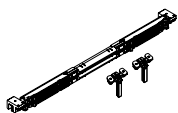

<b>36.557</b>	<b>MUTO Premium XL 80 DORMOTION unit</b> for max. 80 kg, incl. starter min. panel width 810 mm max. panel width 2500 mm		167,00				
---------------	---	--	--------	--	--	--	--

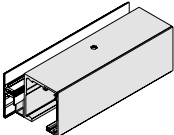
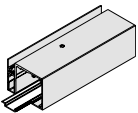
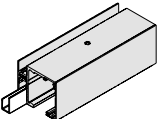
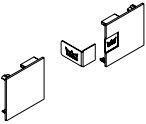

<b>36.558</b>	<b>MUTO Premium XL 150 DORMOTION unit</b> for max. 150 kg, incl. starter min. panel width 1020 mm max. panel width 2500 mm		211,00				
---------------	--	--	--------	--	--	--	--

## Glass door (8–13,5 mm) single-leaf with glass sidelight/ installation at ceiling

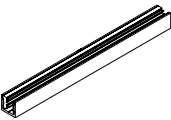
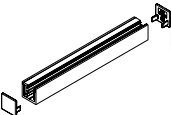
Art. No.	Description	AL silver anod (150)	AL niro anod (157)	AL white p-coat (350)	AL special color anod (199)	AL special color p-coat (399) *		
		€/m	€/m	€/m	€/m	€/m		
<b>Single components</b>								
	<b>MUTO Premium XL 80/150 side panel profile, 69 mm height</b> with gaskets, for 8–13,5 mm glass stock length 6000 mm in fixed length	36.469 36.474	€/Piece	160,00 33,50	184,00 38,00	160,00 33,50	221,00 46,00	221,00 46,00
	<b>MUTO view protection profile</b> for Comfort L, Premium XL and Premium Self-Closing, for side panel profile stock length 6000 mm in fixed length	36.800 36.801	€/Piece	68,00 14,50	78,50 16,50	68,00 14,50	94,00 19,50	94,00 19,50
	<b>MUTO Filling profile</b> for Comfort L, Premium XL and Premium Self-Closing stock length 6000 mm in fixed length	36.802 36.803	€/Piece	68,00 14,50	78,50 16,50	68,00 14,50	94,00 19,50	94,00 19,50
	<b>MUTO Premium XL 80/150 end caps</b> for installation at wall and ceiling	36.556	€/Piece	11,50	11,50	11,50		11,50
	<b>MUTO Premium XL 80/150 end caps</b> for side panel profile, 69 mm height	36.471	€/Piece	11,50	11,50	11,50		11,50
	<b>MUTO Floor profile</b> <b>incl. 2 end caps</b> for Comfort L, Premium XL and Premium Self-Closing for side panel fixing, complete with all gaskets, for 8–13,5 mm glass thickness stock length 6000 mm in fixed length	36.810 36.811	€/Piece	117,00 24,50	134,00 28,00	117,00 24,50	161,00 33,50	161,00 33,50
	<b>MUTO end caps (2 pcs.)</b> for Comfort L, Premium XL and Premium Self-Closing for floor profile - side panel fixing for fixing of sidelight	36.812	€/Piece	8,00	8,00	8,00		8,00

**Delivery status of side panel profile:**  
as part of complete sets = pre-drilled  
as single components = undrilled



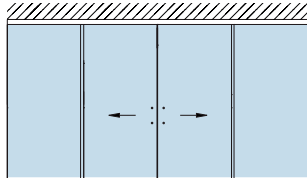

\* With assemblies in special color (399) the end caps will be delivered in plastic anthracite-grey solid-colored.

LSG accessories, Status-indicator and integrated locking mechanism on pages 130–131.

**Glass door (8–13,5 mm) double-leaf with glass sidelights installation at ceiling (optional with Synchro)**

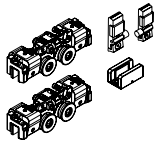
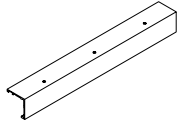
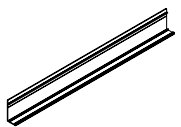

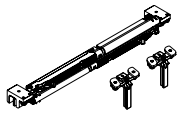
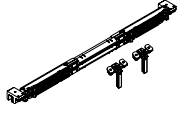

Base parts (000)	AL silver anod (150)	AL niro anod (157)	AL white p-coat (350)	AL special color anod (199)	AL special color p-coat (399)
					*

Art. No.	Description	€/Piece	€/Piece	€/Piece	€/Piece	€/Piece
<b>Single components</b>						
	<b>36.550 MUTO Premium XL 80/150 accessories set</b> consisting of: 2 clamp carriers 2 endstops 1 floor guide	252,00	252,00			
	<b>36.554 MUTO Premium XL 80/150 track profile for installation at ceiling</b> stock length 6000 mm	329,00	383,00	329,00	459,00	459,00
	<b>36.555</b> in fixed length	€/m 68,50	€/m 79,50	€/m 68,50	€/m 95,50	€/m 95,50
	<b>36.566 MUTO Premium XL 80/150 cover profile</b> stock length 6000 mm	128,00	148,00	128,00	178,00	178,00
	<b>36.567</b> in fixed length	€/m 27,00	€/m 30,50	€/m 27,00	€/m 36,50	€/m 36,50
	<b>36.265 MUTO set of view protection brushes for Comfort M, L and Premium XL</b> consisting of: 1 view protection brush 8–10 mm glass thickness 1 view protection brush 12–13.5 mm glass thickness	€/m 9,80				
<b>Single components (optionally retrofittable)</b>						
	<b>36.557 MUTO Premium XL 80 DORMOTION unit</b> for max. 80 kg, incl. starter min. panel width 810 mm max. panel width 2500 mm	172,00				
	<b>36.558 MUTO Premium XL 150 DORMOTION unit</b> for max. 150 kg, incl. starter min. panel width 1020 mm max. panel width 2500 mm	218,00				
	<b>36.560 MUTO Premium XL 80/150 Synchro-Set</b> for max. 80 kg consisting of: 1 elastic rope, 2 deflexion roller	302,00				

\* With assemblies in special color (399) the end caps will be delivered in plastic anthracite-grey solid-colored.

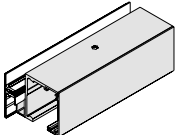
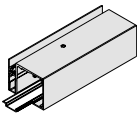
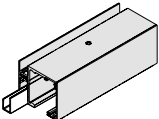
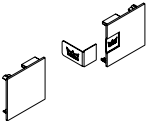

## Glass door (8–13,5 mm) double-leaf with glass sidelights installation at ceiling (optional with Synchro)

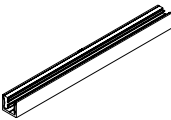
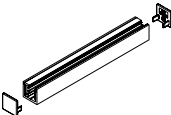
Art. No.	Description	AL silver anod (150)	AL niro anod (157)	AL white p-coat (350)	AL special color anod (199)	AL special color p-coat (399) *
		€/m	€/m	€/m	€/m	€/m
<b>Single components</b>						
	<b>MUTO Premium XL 80/150 side panel profile, 69 mm height</b> with gaskets, for 8–13,5 mm glass stock length 6000 mm in fixed length	€/Piece 160,00 33,50	184,00 38,00	160,00 33,50	221,00 46,00	221,00 46,00
	<b>MUTO view protection profile</b> for Comfort L, Premium XL and Premium Self-Closing, for side panel profile stock length 6000 mm in fixed length	€/Piece 68,00 14,50	78,50 16,50	68,00 14,50	94,00 19,50	94,00 19,50
	<b>MUTO Filling profile</b> for Comfort L, Premium XL and Premium Self-Closing stock length 6000 mm in fixed length	€/Piece 68,00 14,50	78,50 16,50	68,00 14,50	94,00 19,50	94,00 19,50
	<b>MUTO Premium XL 80/150 end caps</b> for installation at wall and ceiling	€/Piece 11,50	11,50	11,50		11,50
	<b>MUTO Premium XL 80/150 end caps</b> for side panel profile, 69 mm height	€/Piece 11,50	11,50	11,50		11,50
	<b>MUTO Floor profile incl. 2 end caps</b> for Comfort L, Premium XL and Premium Self-Closing for side panel fixing, complete with all gaskets, for 8–13,5 mm glass thickness stock length 6000 mm in fixed length	€/Piece 117,00 24,50	134,00 28,00	117,00 24,50	161,00 33,50	161,00 33,50
	<b>MUTO end caps (2 pcs.)</b> for Comfort L, Premium XL and Premium Self-Closing for floor profile - side panel fixing	€/Piece 8,00	8,00	8,00		8,00

**Delivery status of side panel profile:**  
as part of complete sets = pre-drilled  
as single components = undrilled

\* With assemblies in special color (399) the end caps will be delivered in plastic anthracite-grey solid-colored.

Glass door (8–13,5 mm) single-leaf with glass overpanel and glass sidelights

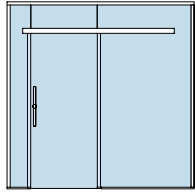

AL silver anod (150)	AL niro anod (157)	AL white p-coat (350)	AL special color anod (199)	AL special color p-coat (399)
				*

Art. No.	Description	€/Piece	€/Piece	€/Piece	€/Piece	€/Piece
----------	-------------	---------	---------	---------	---------	---------

Complete sets (inclusive DORMOTION)

Defined lengths

MUTO Premium XL 80/150

consisting of:  
 1 track profile, 1 cover profile,  
 1 counter profile  
 2 clamp carriers  
 (for 8–13.5 mm glass thickness)  
 with anti-jump mechanism  
 2 endstops with safety catch and anti jump device  
 1 floor guide  
 2 end caps  
 incl. brush profile  
 1 DORMOTION unit

max. 80 kg, incl. DORMOTION XL – 80

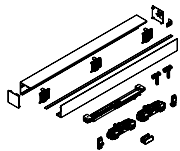

36.506	850 mm clear opening width/910 mm panel width/1887 mm profile length	715,00	771,00	715,00	925,00	925,00
36.507	1050 mm clear opening width/1110 mm panel width/2287 mm profile length	814,00	886,00	814,00	1063,00	1063,00
36.508	1250 mm clear opening width/1310 mm panel width/2687 mm profile length	897,00	982,00	897,00	1179,00	1179,00

max. 150 kg, incl. DORMOTION XL – 150

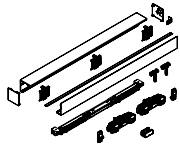

36.513	1250 mm clear opening width/1310 mm panel width/2687 mm profile length	880,00	936,00	880,00	1123,00	1123,00
36.514	1400 mm clear opening width/1460 mm panel width/2987 mm profile length	946,00	1012,00	946,00	1216,00	1216,00

Individual lengths

MUTO Premium XL 80/150

consisting of:  
 1 track profile max. 5067 mm  
 1 cover profile max. 5067 mm  
 1 counter profile max. 5067 mm  
 2 clamp carriers  
 (for 8–13.5 mm glass thickness)  
 with anti-jump mechanism  
 2 endstops with safety catch and anti jump device  
 1 floor guide  
 2 end caps  
 incl. view protection brushes max. 5067 mm  
 1 DORMOTION unit

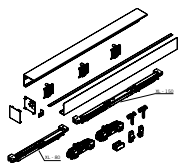

36.524	max. 80 kg, incl. DORMOTION XL – 80 clear opening width min. 750 / max. 2440 mm panel width min. 810 / max. 2500 mm	Basic 1887 mm Surcharge per mm Max. 5067 mm	715,00 0,30	771,00 0,30	715,00 0,30	925,00 0,40	925,00 0,40
36.525	max. 150 kg, incl. DORMOTION XL – 150 clear opening min. 960 / max. 2440 mm panel width min. 1020 / max. 2500 mm	Basic 2687 mm Surcharge per mm Max. 5067 mm	880,00 0,30	936,00 0,30	880,00 0,30	1123,00 0,40	1123,00 0,40

\* With assemblies in special color (399) the end caps will be delivered in plastic anthracite-grey solid-colored.

## Glass door (8–13,5 mm) single-leaf with glass overpanel and glass sidelights

AL silver anod (150)	AL niro anod (157)	AL white p-coat (350)	AL special color anod (199)	AL special color p-coat (399)
				*

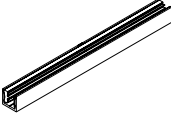
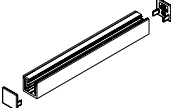
Art. No.	Description	€/Piece	€/Piece	€/Piece	€/Piece	€/Piece
<b>Single components</b>						
	<b>MUTO Floor profile incl. 2 end caps</b> for Comfort L, Premium XL and Premium Self-Closing for side panel fixing, complete with all gaskets, for 8–13,5 mm glass thickness stock length 6000 mm					
	<b>36.810</b>	117,00	134,00	117,00	161,00	161,00
		€/m	€/m	€/m	€/m	€/m
	<b>36.811</b> in fixed length	24,50	28,00	24,50	33,50	33,50
	<b>36.812</b> <b>MUTO end caps (2 pcs.)</b> for Comfort L, Premium XL and Premium Self-Closing for floor profile - side panel fixing	8,00	8,00	8,00		8,00

\* With assemblies in special color (399) the end caps will be delivered in plastic anthracite-grey solid-colored.

LSG accessories, Status-indicator and integrated locking mechanism on pages 130–131.

**Glass door (8–13,5 mm) double-leaf with glass overpanel and glass sidelights (optional with Synchro)**

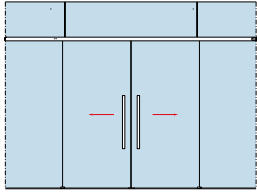

AL silver anod (150)	AL niro anod (157)	AL white p-coat (350)	AL special color anod (199)	AL special color p-coat (399)
----------------------	--------------------	-----------------------	-----------------------------	-------------------------------

\*

Art. No.	Description	€/Piece	€/Piece	€/Piece	€/Piece	€/Piece
----------	-------------	---------	---------	---------	---------	---------

**Complete sets (inclusive DORMOTION, optional with Synchro)**

**Individual lengths**

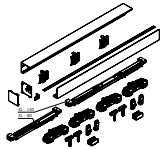

**MUTO Premium XL 80/150 for two panels**



- consisting of:
- 1 track profile max. 5892 mm
  - 1 cover profile max. 5892 mm
  - 4 clamp carriers (for 8–13.5 mm glass thickness) with anti-jump mechanism
  - 4 endstops with safety catch and anti jump device
  - 2 floor guides
  - 2 end caps
  - incl. view protection brushes max. 5892 mm
  - 2 DORMOTION units

<b>36.530</b>	<b>max. 80 kg</b> panel width min. 810 mm	Basic 3774 mm Surcharge per mm Max. 5892 mm	1431,00	1541,00	1431,00	1849,00	1849,00
			0,30	0,30	0,30	0,40	0,40
<b>36.531</b>	<b>max. 150 kg</b> panel width min. 1020 mm	Basic 5374 mm Surcharge per mm Max. 5892 mm	1762,00	1871,00	1762,00	2246,00	2246,00
			0,30	0,30	0,30	0,40	0,40

\* With assemblies in special color (399) the end caps will be delivered in plastic anthracite-grey solid-colored.

**Glass door (8–13,5 mm) double-leaf with glass overpanel and glass sidelights (optional with Synchro)**

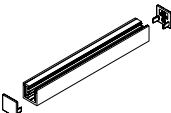
Base parts (000)	AL silver anod (150)	AL niro anod (157)	AL white p-coat (350)	AL special color anod (199)	AL special color p-coat (399)
					*

Art. No.	Description	€/Piece	€/Piece	€/Piece	€/Piece	€/Piece	€/Piece
<b>Single components</b>							
<b>MUTO Floor profile incl. 2 end caps</b>							
for Comfort L, Premium XL and Premium Self-Closing for side panel fixing, complete with all gaskets, for 8–13,5 mm glass thickness stock length 6000 mm							
	<b>36.810</b>	117,00	134,00	117,00	161,00	161,00	
		€/m	€/m	€/m	€/m	€/m	
	<b>36.811</b>	24,50	28,00	24,50	33,50	33,50	
	in fixed length						
	<b>36.812</b>	8,00	8,00	8,00			8,00
	<b>MUTO end caps (2 pcs.)</b>						
	for Comfort L, Premium XL and Premium Self-Closing for floor profile - side panel fixing						
<b>Single components (optionally retrofittable)</b>							
	<b>36.560</b>	302,00					
	<b>MUTO Premium XL 80/150 Synchro-Set</b>						
	for max. 80 kg consisting of: 1 elastic rope, 2 deflexion roller						

\* With assemblies in special color (399) the end caps will be delivered in plastic anthracite-grey solid-colored.

LSG accessories, Status-indicator and integrated locking mechanism on pages 130–131.

Timber door (28–50 mm) single-leaf for installation at wall

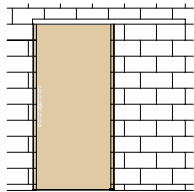

AL silver anod (150)	AL niro anod (157)	AL white p-coat (350)	AL special color anod (199)	AL special color p-coat (399)
----------------------	--------------------	-----------------------	-----------------------------	-------------------------------

\*

Art. No.	Description	€/Piece	€/Piece	€/Piece	€/Piece	€/Piece
----------	-------------	---------	---------	---------	---------	---------

**Complete sets (inclusive DORMOTION)**  
For Timber door application the adapter profile 36.461 / 36.464 will be necessitated

**Defined lengths**

**MUTO Premium XL 80/150**

consisting of:  
1 track profile  
1 cover profile  
2 clamp carriers (for 8–13.5 mm glass thickness) with anti-jump mechanism  
2 endstops with safety catch and anti jump device  
1 floor guide  
2 end caps  
incl. brush profile  
1 DORMOTION unit

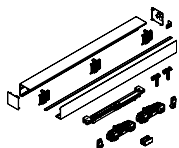

<b>36.500</b>	<b>max. 80 kg, incl. DORMOTION XL – 80</b> 900 mm panel width/1780 mm profile length	596,00	642,00	596,00	771,00	771,00
<b>36.501</b>	1200 mm panel width/2380 mm profile length	679,00	739,00	679,00	886,00	886,00
<b>36.502</b>	1450 mm panel width/2880 mm profile length	747,00	818,00	747,00	982,00	982,00

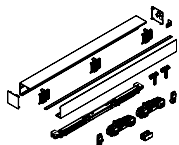

<b>36.509</b>	<b>max. 150 kg, incl. DORMOTION XL – 150</b> 1250 mm panel width/2480 mm profile length	734,00	780,00	734,00	936,00	936,00
<b>36.510</b>	1450 mm panel width/2880 mm profile length	788,00	844,00	788,00	1012,00	1012,00

**Individual lengths**

**MUTO Premium XL 80/150**

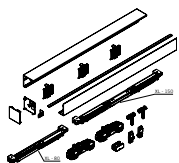

consisting of:  
1 track profile max. 5000 mm  
1 cover profile max. 5000 mm  
2 clamp carriers (for 8–13.5 mm glass thickness) with anti-jump mechanism  
2 endstops with safety catch and anti jump device  
1 floor guide  
2 end caps  
incl. view protection brushes max. 5000 mm  
1 DORMOTION unit



<b>36.520</b>	<b>max. 80 kg, incl. DORMOTION XL – 80</b> panel width min. 810/max. 2500 mm	Basic 1780 mm Surcharge per mm	596,00 0,30	642,00 0,30	596,00 0,30	771,00 0,40	771,00 0,40
<b>36.521</b>	<b>max. 150 kg, incl. DORMOTION XL – 150</b> panel width min. 1020/max. 2500 mm	Basic 2480 mm Surcharge per mm	734,00 0,30	780,00 0,30	734,00 0,30	936,00 0,40	936,00 0,40

\* With assemblies in special color (399) the end caps will be delivered in plastic anthracite-grey solid-colored.

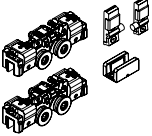
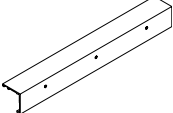
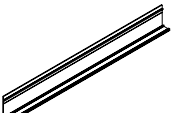
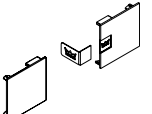
## Timber door (28–50 mm) single-leaf for installation at wall

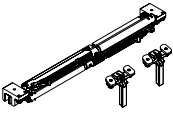
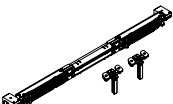
Art. No.	Description	Base parts (000)	AL silver anod (150)	AL niro anod (157)	AL white p-coat (350)	AL special color anod (199)	AL special color p-coat (399)	★
		€/Piece	€/Piece	€/Piece	€/Piece	€/Piece	€/Piece	
<b>Single components</b>								
	<b>MUTO Premium XL 80/150 adapterprofile for timber panels</b> Profile 12,5 x 36 mm + 12,5 x 4 mm, incl. floor guide for timber panels, incl. accessories 1460 mm	55,00						
36.461		€/m						
36.464	in fixed length max. 2500 mm	69,50						
	<b>MUTO Premium XL 80/150 accessories set</b> consisting of: 2 clamp carriers 2 endstops 1 floor guide	252,00	252,00					
36.550								
	<b>MUTO Premium XL 80/150 track profile for installation at wall</b> stock length 6000 mm	329,00	383,00	329,00	459,00	459,00		
36.552		€/m	€/m	€/m	€/m	€/m		
36.553	in fixed length	68,50	79,50	68,50	95,50	95,50		
	<b>MUTO Premium XL 80/150 cover profile</b> stock length 6000 mm	128,00	148,00	128,00	178,00	178,00		
36.566		€/m	€/m	€/m	€/m	€/m		
36.567	in fixed length	27,00	30,50	27,00	36,50	36,50		
	<b>MUTO Premium XL 80/150 end caps</b> for installation at wall and ceiling	11,50	11,50	11,50			11,50	
36.556								
	<b>MUTO set of view protection brushes for Comfort M, L and Premium XL</b> consisting of: 1 view protection brush 8–10 mm glass thickness 1 view protection brush 12–13.5 mm glass thickness	9,80						
36.265		€/m						
<b>Single components (optionally retrofittable)</b>								
	<b>MUTO Premium XL 80 DORMOTION unit</b> for max. 80 kg, incl. starter min. panel width 810 mm max. panel width 2500 mm	172,00						
36.557								
	<b>MUTO Premium XL 150 DORMOTION unit</b> for max. 150 kg, incl. starter min. panel width 1020 mm max. panel width 2500 mm	218,00						
36.558								

\* With assemblies in special color (399) the end caps will be delivered in plastic anthracite-grey solid-colored.

**Timber door (28–50 mm) double-leaf for installation at wall (optional with Synchro)**

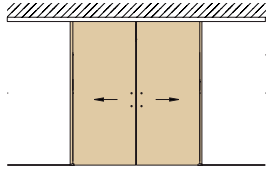

AL silver anod (150)	AL niro anod (157)	AL white p-coat (350)	AL special color anod (199)	AL special color p-coat (399) *
-------------------------------	-----------------------------	--------------------------------	---	--

Art. No.	Description	€/Piece	€/Piece	€/Piece	€/Piece	€/Piece
----------	-------------	---------	---------	---------	---------	---------

**Complete sets (inclusive DORMOTION, optional with Synchro)**  
**For Timber door application the adapter profile**  
**36.461 / 36.464 will be necessitated**

**Individual lengths**

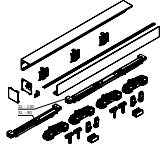

**MUTO Premium XL 80/150**  
**for two panels**

- consisting of:  
 1 track profile max. 5880 mm  
 1 cover profile max. 5880 mm  
 4 clamp carriers  
 (for 8–13.5 mm glass thickness)  
 with anti-jump mechanism  
 4 endstops with safety catch and anti jump device  
 2 floor guides  
 2 end caps  
 incl. view protection brushes max. 5880 mm  
 2 DORMOTION units

<b>36.526</b>	<b>max. 80 kg</b> panel width: min. 810 mm, max. 1470 mm	Basic 3560 mm Surcharge per mm Max. 5880 mm	1193,00	1284,00	1193,00	1541,00	1541,00
			0,30	0,30	0,30	0,40	0,40
<b>36.527</b>	<b>max. 150 kg</b> panel width: min. 1020 mm, max. 1470 mm	Basic 4960 mm Surcharge per mm Max. 5880 mm	1468,00	1559,00	1468,00	1871,00	1871,00
			0,30	0,30	0,30	0,40	0,40

\* With assemblies in special color (399) the end caps will be delivered in plastic anthracite-grey solid-colored.



## Timber door (28–50 mm) double-leaf for installation at wall (optional with Synchro)

Art. No.	Description	Base parts	AL silver anod	AL niro anod	AL white p-coat	AL special color anod	AL special color p-coat
		(000)	(150)	(157)	(350)	(199)	(399)
		€/Piece	€/Piece	€/Piece	€/Piece	€/Piece	€/Piece
<b>Single components</b>							
	<b>MUTO Premium XL 80/150 adapterprofile for timber panels</b> Profile 12,5 x 36 mm + 12,5 x 4 mm, incl. floor guide for timber panels, incl. accessories 1460 mm	55,00					
36.461		€/m					
36.464	in fixed length max. 2500 mm	69,50					
	<b>MUTO Premium XL 80/150 accessories set</b> consisting of: 2 clamp carriers 2 endstops 1 floor guide	252,00	252,00				
36.550							
	<b>MUTO Premium XL 80/150 track profile for installation at wall</b> stock length 6000 mm	329,00	383,00	329,00	459,00	459,00	
36.552		€/m	€/m	€/m	€/m	€/m	
36.553	in fixed length	68,50	79,50	68,50	95,50	95,50	
	<b>MUTO Premium XL 80/150 cover profile</b> stock length 6000 mm	128,00	148,00	128,00	178,00	178,00	
36.566		€/m	€/m	€/m	€/m	€/m	
36.567	in fixed length	27,00	30,50	27,00	36,50	36,50	
	<b>MUTO Premium XL 80/150 end caps</b> for installation at wall and ceiling	11,50	11,50	11,50			11,50
36.556							
	<b>MUTO set of view protection brushes for Comfort M, L and Premium XL</b> consisting of: 1 view protection brush 8–10 mm glass thickness 1 view protection brush 12–13.5 mm glass thickness	€/m					
36.265		9,80					
<b>Single components (optionally retrofittable)</b>							
	<b>MUTO Premium XL 80 DORMOTION unit</b> for max. 80 kg, incl. starter min. panel width 810 mm max. panel width 2500 mm	172,00					
36.557							
	<b>MUTO Premium XL 150 DORMOTION unit</b> for max. 150 kg, incl. starter min. panel width 1020 mm max. panel width 2500 mm	218,00					
36.558							
	<b>MUTO Premium XL 80/150 Synchro-Set</b> for max. 80 kg consisting of: 1 elastic rope, 2 deflexion roller	302,00					
36.560							

Timber door (28–50 mm) single-leaf for installation at ceiling

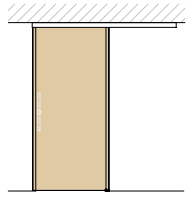

AL silver anod (150)	AL niro anod (157)	AL white p-coat (350)	AL special color anod (199)	AL special color p-coat (399)
				*

Art. No.	Description	€/Piece	€/Piece	€/Piece	€/Piece	€/Piece	€/Piece
----------	-------------	---------	---------	---------	---------	---------	---------

**Complete sets (inclusive DORMOTION)**  
**For Timber door application the adapter profile 36.461 / 36.464 will be necessitated**

**Defined lengths**

**MUTO Premium XL 80/150**

consisting of:  
 1 track profile  
 1 cover profile  
 2 clamp carriers  
 (for 8–13.5 mm glass thickness)  
 with anti-jump mechanism  
 2 endstops with safety catch and anti jump device  
 1 floor guide  
 2 end caps  
 incl. brush profile  
 1 DORMOTION unit

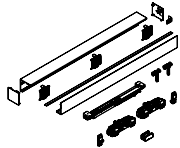

<b>36.503</b>	<b>max. 80 kg, incl. DORMOTION XL – 80</b> 900 mm panel width/1780 mm profile length	596,00	642,00	596,00	771,00	771,00
<b>36.504</b>	1200 mm panel width/2380 mm profile length	679,00	739,00	679,00	886,00	886,00
<b>36.505</b>	1450 mm panel width/2880 mm profile length	747,00	818,00	747,00	982,00	982,00

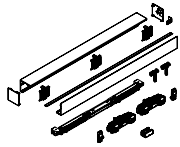

<b>36.511</b>	<b>max. 150 kg, incl. DORMOTION XL – 150</b> 1250 mm panel width/2480 mm profile length	734,00	780,00	734,00	936,00	936,00
<b>36.512</b>	1450 mm panel width/2880 mm profile length	788,00	844,00	788,00	1012,00	1012,00

**Individual lengths**

**MUTO Premium XL 80/150**

consisting of:  
 1 track profile max. 5000 mm  
 1 cover profile max. 5000 mm  
 2 clamp carriers  
 (for 8–13.5 mm glass thickness)  
 with anti-jump mechanism  
 2 endstops with safety catch and anti jump device  
 1 floor guide  
 2 end caps  
 incl. view protection brushes max. 5000 mm  
 1 DORMOTION unit

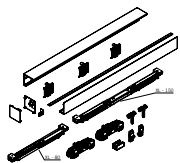

<b>36.522</b>	<b>max. 80 kg, incl. DORMOTION XL – 80</b> panel width min. 810/max. 2500 mm	Basic 1780 mm Surcharge per mm	596,00 0,30	642,00 0,30	596,00 0,30	771,00 0,40	771,00 0,40
<b>36.523</b>	<b>max. 150 kg, incl. DORMOTION XL – 150</b> panel width min. 1020/max. 2500 mm	Basic 2480 mm Surcharge per mm	734,00 0,30	780,00 0,30	734,00 0,30	936,00 0,40	936,00 0,40

\* With assemblies in special color (399) the end caps will be delivered in plastic anthracite-grey solid-colored.

## Timber door (28–50 mm) single-leaf for installation at ceiling

Art. No.	Description	Base parts (000)	AL silver anod (150)	AL niro anod (157)	AL white p-coat (350)	AL special color anod (199)	AL special color p-coat (399)	€ / Piece	€ / Piece	€ / Piece	€ / Piece	€ / Piece	€ / Piece
<b>Single components</b>													
	<b>MUTO Premium XL 80/150 adapterprofile for timber panels</b>												
	Profile 12,5 x 36 mm + 12,5 x 4 mm, incl. floor guide for timber panels, incl. accessories												
36.461	1460 mm												55,00
36.464	in fixed length max. 2500 mm												€ / m 69,50
	<b>MUTO Premium XL 80/150 accessories set</b>												
	consisting of: 2 clamp carriers 2 endstops 1 floor guide												
36.550													252,00
	<b>MUTO Premium XL 80/150 track profile for installation at ceiling</b>												
	stock length 6000 mm												
36.554													329,00
36.555	in fixed length												€ / m 68,50
	<b>MUTO Premium XL 80/150 cover profile</b>												
	stock length 6000 mm												
36.566													128,00
36.567	in fixed length												€ / m 27,00
	<b>MUTO Premium XL 80/150 end caps</b>												
	for installation at wall and ceiling												
36.556													11,50
	<b>MUTO set of view protection brushes for Comfort M, L and Premium XL</b>												
	consisting of: 1 view protection brush 8–10 mm glass thickness 1 view protection brush 12–13.5 mm glass thickness												
36.265													€ / m 9,80
<b>Single components (optionally retrofittable)</b>													
	<b>MUTO Premium XL 80 DORMOTION unit</b>												
	for max. 80 kg, incl. starter min. panel width 810 mm max. panel width 2500 mm												
36.557													172,00
	<b>MUTO Premium XL 150 DORMOTION unit</b>												
	for max. 150 kg, incl. starter min. panel width 1020 mm max. panel width 2500 mm												
36.558													218,00

\* With assemblies in special color (399) the end caps will be delivered in plastic anthracite-grey solid-colored.

**Timber door (28–50 mm) double-leaf for installation at ceiling (optional with Synchro)**

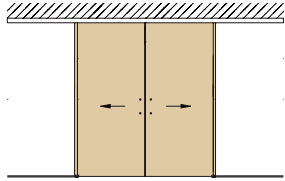

AL silver anod (150)	AL niro anod (157)	AL white p-coat (350)	AL special color anod (199)	AL special color p-coat (399)
				*

Art. No.	Description	€/Piece	€/Piece	€/Piece	€/Piece	€/Piece
----------	-------------	---------	---------	---------	---------	---------

**Complete sets (inclusive DORMOTION, optional with Synchro)  
For Timber door application the adapter profile  
36.461 / 36.464 will be necessitated**

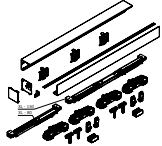

**Individual lengths**





**MUTO Premium XL 80/150  
for two panels**

- consisting of:  
 1 track profile max. 5880 mm  
 1 cover profile max. 5880 mm  
 4 clamp carriers (for 8–13.5 mm glass thickness) with anti-jump mechanism  
 4 endstops with safety catch and anti jump device  
 2 floor guides  
 2 end caps  
 incl. view protection brushes max. 5880 mm  
 2 DORMOTION units

<b>36.528</b>	<b>max. 80 kg</b> panel width: min. 810 mm, max. 1470 mm	Basic 3560 mm Surcharge per mm Max. 5880 mm	1193,00	1284,00	1193,00	1541,00	1541,00
			0,30	0,30	0,30	0,40	0,40
<b>36.529</b>	<b>max. 150 kg</b> panel width: min. 1020 mm, max. 1470 mm	Basic 4960 mm Surcharge per mm Max. 5880 mm	1468,00	1559,00	1468,00	1871,00	1871,00
			0,30	0,30	0,30	0,40	0,40

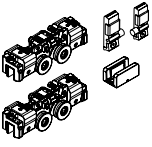
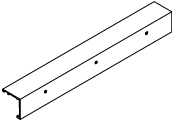
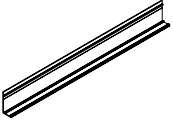
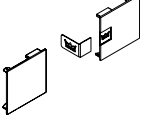
\* With assemblies in special color (399) the end caps will be delivered in plastic anthracite-grey solid-colored.

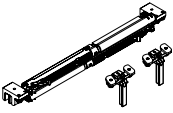
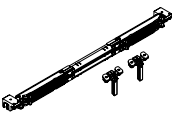
## Timber door (28–50 mm) double-leaf for installation at ceiling (optional with Synchro)

Art. No.	Description	Base parts (000)	AL silver anod (150)	AL niro anod (157)	AL white p-coat (350)	AL special color anod (199)	AL special color p-coat (399)	*
		€/Piece	€/Piece	€/Piece	€/Piece	€/Piece	€/Piece	€/Piece
<b>Single components</b>								
	<b>36.461</b> MUTO Premium XL 80/150 adapterprofile for timber panels Profile 12,5 x 36 mm + 12,5 x 4 mm, incl. floor guide for timber panels, incl. accessories 1460 mm	55,00						
	<b>36.464</b> in fixed length max. 2500 mm	€/m	69,50					
	<b>36.550</b> MUTO Premium XL 80/150 accessories set consisting of: 2 clamp carriers 2 endstops 1 floor guide		252,00	252,00				
	<b>36.554</b> MUTO Premium XL 80/150 track profile for installation at ceiling stock length 6000 mm	329,00	383,00	329,00	459,00	459,00		
	<b>36.555</b> in fixed length	€/m	68,50	79,50	68,50	95,50	95,50	
	<b>36.566</b> MUTO Premium XL 80/150 cover profile stock length 6000 mm	128,00	148,00	128,00	178,00	178,00		
	<b>36.567</b> in fixed length	€/m	27,00	30,50	27,00	36,50	36,50	
	<b>36.556</b> MUTO Premium XL 80/150 end caps for installation at wall and ceiling		11,50	11,50	11,50		11,50	
	<b>36.265</b> MUTO set of view protection brushes for Comfort M, L and Premium XL consisting of: 1 view protection brush 8–10 mm glass thickness 1 view protection brush 12–13.5 mm glass thickness	€/m	9,80					
<b>Single components (optionally retrofittable)</b>								
	<b>36.557</b> MUTO Premium XL 80 DORMOTION unit for max. 80 kg, incl. starter min. panel width 810 mm max. panel width 2500 mm		172,00					
	<b>36.558</b> MUTO Premium XL 150 DORMOTION unit for max. 150 kg, incl. starter min. panel width 1020 mm max. panel width 2500 mm		218,00					
	<b>36.560</b> MUTO Premium XL 80/150 Synchro-Set for max. 80 kg consisting of: 1 elastic rope, 2 deflexion roller		302,00					

\* With assemblies in special color (399) the end caps will be delivered in plastic anthracite-grey solid-colored.

**Timber door (28–50 mm) single-leaf with glass sidelight/s installation at ceiling**

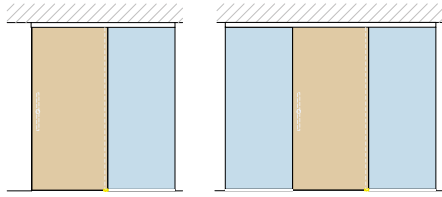

Base parts (000)	AL silver anod (150)	AL niro anod (157)	AL white p-coat (350)	AL special color anod (199)	AL special color p-coat (399)
					*
€/Piece	€/Piece	€/Piece	€/Piece	€/Piece	€/Piece

Art. No. Description

**Single components**  
For Timber door application the adapter profile 36.461 / 36.464 will be necessitated



**36.461** MUTO Premium XL 80/150 adapterprofile for timber panels  
Profile 12,5 x 36 mm + 12,5 x 4 mm, incl. floor guide for timber panels, incl. accessories 1460 mm  
**36.464** in fixed length max. 2500 mm

55,00  
€/m  
69,50

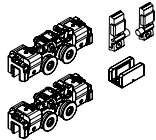

**36.550** MUTO Premium XL 80/150 accessories set consisting of:  
2 clamp carriers  
2 endstops  
1 floor guide

252,00 252,00

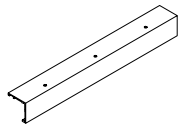

**36.554** MUTO Premium XL 80/150 track profile for installation at ceiling  
stock length 6000 mm  
**36.555** in fixed length

329,00	383,00	329,00	459,00	459,00
€/m	€/m	€/m	€/m	€/m
68,50	79,50	68,50	95,50	95,50

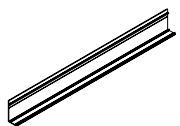

**36.566** MUTO Premium XL 80/150 cover profile  
stock length 6000 mm  
**36.567** in fixed length

128,00	148,00	128,00	178,00	178,00
€/m	€/m	€/m	€/m	€/m
27,00	30,50	27,00	36,50	36,50



**36.265** MUTO set of view protection brushes for Comfort M, L and Premium XL consisting of:  
1 view protection brush 8–10 mm glass thickness  
1 view protection brush 12–13.5 mm glass thickness

€/m  
9,80

**Single components (optionally retrofittable)**

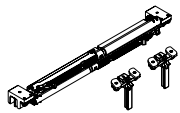

**36.557** MUTO Premium XL 80 DORMOTION unit for max. 80 kg, incl. starter  
min. panel width 810 mm  
max. panel width 2500 mm

172,00

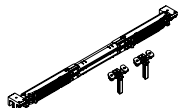

**36.558** MUTO Premium XL 150 DORMOTION unit for max. 150 kg, incl. starter  
min. panel width 1020 mm  
max. panel width 2500 mm

218,00

\* With assemblies in special color (399) the end caps will be delivered in plastic anthracite-grey solid-colored.

## Timber door (28–50 mm) single-leaf with glass sidelight/ installation at ceiling

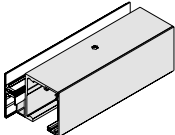
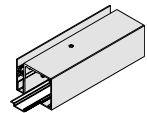
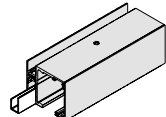
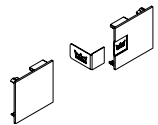
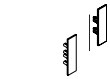
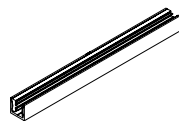
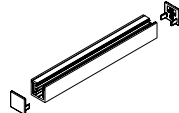
Art. No.	Description	AL silver anod (150)	AL niro anod (157)	AL white p-coat (350)	AL special color anod (199)	AL special color p-coat (399)
		€/m	€/m	€/m	€/m	€/m
<b>Single components</b>						
	<b>MUTO Premium XL 80/150 side panel profile, 69 mm height</b> with gaskets, for 8–13,5 mm glass stock length 6000 mm in fixed length	€ / Piece				
36.469		160,00	184,00	160,00	221,00	221,00
36.474		33,50	38,00	33,50	46,00	46,00
	<b>MUTO view protection profile</b> for Comfort L, Premium XL and Premium Self-Closing, for side panel profile stock length 6000 mm in fixed length	€ / Piece				
36.800		68,00	78,50	68,00	94,00	94,00
36.801		14,50	16,50	14,50	19,50	19,50
	<b>MUTO Filling profile</b> for Comfort L, Premium XL and Premium Self-Closing stock length 6000 mm in fixed length	€ / Piece				
36.802		68,00	78,50	68,00	94,00	94,00
36.803		14,50	16,50	14,50	19,50	19,50
	<b>MUTO Premium XL 80/150 end caps</b> for installation at wall and ceiling	€ / Piece				
36.556		11,50	11,50	11,50		11,50
	<b>MUTO Premium XL 80/150 end caps</b> for side panel profile, 69 mm height	€ / Piece				
36.471		11,50	11,50	11,50		11,50
	<b>MUTO Floor profile</b> <b>incl. 2 end caps</b> for Comfort L, Premium XL and Premium Self-Closing for side panel fixing, complete with all gaskets, for 8–13,5 mm glass thickness stock length 6000 mm in fixed length	€ / Piece				
36.810		117,00	134,00	117,00	161,00	161,00
36.811		24,50	28,00	24,50	33,50	33,50
	<b>MUTO end caps (2 pcs.)</b> for Comfort L, Premium XL and Premium Self-Closing for floor profile - side panel fixing	€ / Piece				
36.812		8,00	8,00	8,00		8,00

**Delivery status of side panel profile:**  
as part of complete sets = pre-drilled  
as single components = undrilled

\* With assemblies in special color (399) the end caps will be delivered in plastic anthracite-grey solid-colored.

**Timber door (28–50 mm) double-leaf with glass sidelights installation at ceiling (optional with Synchro)**

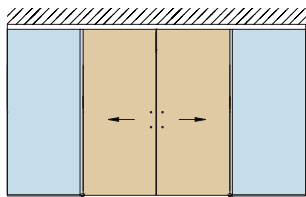

Base parts (000)	AL silver anod (150)	AL niro anod (157)	AL white p-coat (350)	AL special color anod (199)	AL special color p-coat (399)
					*

Art. No.	Description	€/Piece	€/Piece	€/Piece	€/Piece	€/Piece	€/Piece
----------	-------------	---------	---------	---------	---------	---------	---------

**Single components**  
For Timber door application the adapter profile 36.461 / 36.464 will be necessitated



**36.461** MUTO Premium XL 80/150 adapterprofile for timber panels  
Profile 12,5 x 36 mm + 12,5 x 4 mm,  
incl. floor guide for timber panels, incl. accessories  
1460 mm

53,50  
€/m

**36.464** in fixed length max. 2500 mm

67,50

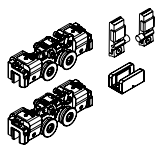

**36.550** MUTO Premium XL 80/150 accessories set  
consisting of:  
2 clamp carriers  
2 endstops  
1 floor guide

244,00 244,00

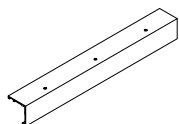

**36.554** MUTO Premium XL 80/150 track profile  
for installation at ceiling  
stock length 6000 mm

319,00 371,00 319,00 445,00 445,00  
€/m €/m €/m €/m €/m

**36.555** in fixed length

66,50 77,00 66,50 92,50 92,50

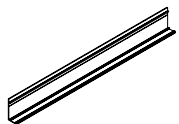

**36.566** MUTO Premium XL 80/150 cover profile  
stock length 6000 mm

124,00 143,00 124,00 172,00 172,00  
€/m €/m €/m €/m €/m

**36.567** in fixed length

26,00 29,50 26,00 35,50 35,50



**36.265** MUTO set of view protection brushes  
for Comfort M, L and Premium XL  
consisting of:  
1 view protection brush  
8–10 mm glass thickness  
1 view protection brush  
12–13.5 mm glass thickness

€/m  
9,50

**Single components (optionally retrofittable)**

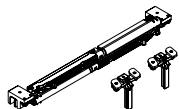

**36.557** MUTO Premium XL 80 DORMOTION unit  
for max. 80 kg,  
incl. starter  
min. panel width 810 mm  
max. panel width 2500 mm

167,00

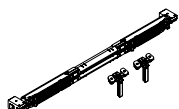



**36.558** MUTO Premium XL 150 DORMOTION unit  
for max. 150 kg,  
incl. starter  
min. panel width 1020 mm  
max. panel width 2500 mm

211,00

\* With assemblies in special color (399) the end caps will be delivered in plastic anthracite-grey solid-colored.

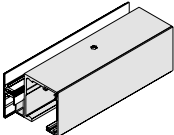
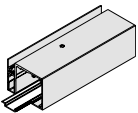
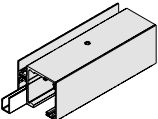
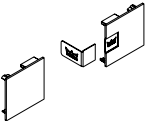

## Timber door (28–50 mm) double-leaf with glass sidelights installation at ceiling (optional with Synchro)

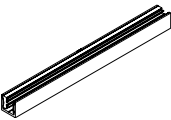
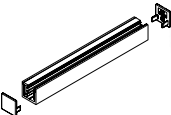
Art. No.	Description	AL silver anod (150)	AL niro anod (157)	AL white p-coat (350)	AL special color anod (199)	AL special color p-coat (399) *	
		€/m	€/m	€/m	€/m	€/m	
<b>Single components</b>							
	<b>MUTO Premium XL 80/150 side panel profile, 69 mm height</b> with gaskets, for 8–13,5 mm glass stock length 6000 mm in fixed length	€/Piece	160,00 33,50	184,00 38,00	160,00 33,50	221,00 46,00	221,00 46,00
	<b>MUTO view protection profile</b> for Comfort L, Premium XL and Premium Self-Closing, for side panel profile stock length 6000 mm in fixed length	€/Piece	68,00 14,50	78,50 16,50	68,00 14,50	94,00 19,50	94,00 19,50
	<b>MUTO Filling profile</b> for Comfort L, Premium XL and Premium Self-Closing stock length 6000 mm in fixed length	€/Piece	68,00 14,50	78,50 16,50	68,00 14,50	94,00 19,50	94,00 19,50
	<b>MUTO Premium XL 80/150 end caps</b> for installation at wall and ceiling	€/Piece	11,50	11,50	11,50		11,50
	<b>MUTO Premium XL 80/150 end caps</b> for side panel profile, 69 mm height	€/Piece	11,50	11,50	11,50		11,50
	<b>MUTO Floor profile incl. 2 end caps</b> for Comfort L, Premium XL and Premium Self-Closing for side panel fixing, complete with all gaskets, for 8–13,5 mm glass thickness stock length 6000 mm in fixed length	€/Piece	117,00 24,50	134,00 28,00	117,00 24,50	161,00 33,50	161,00 33,50
	<b>MUTO end caps (2 pcs.)</b> for Comfort L, Premium XL and Premium Self-Closing for floor profile - side panel fixing	€/Piece	8,00	8,00	8,00		8,00

**Delivery status of side panel profile:**  
as part of complete sets = pre-drilled  
as single components = undrilled

\* With assemblies in special color (399) the end caps will be delivered in plastic anthracite-grey solid-colored.

Timber door (28–50 mm) single-leaf with glass overpanel and glass sidelights

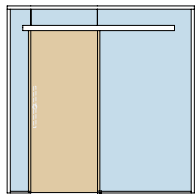

AL silver anod (150)	AL niro anod (157)	AL white p-coat (350)	AL special color anod (199)	AL special color p-coat (399)
				*

Art. No.	Description	€/Piece	€/Piece	€/Piece	€/Piece	€/Piece
----------	-------------	---------	---------	---------	---------	---------

**Complete sets (inclusive DORMOTION)**  
**For Timber door application the adapter profile**  
**36.461 / 36.464 will be necessitated**

**Defined lengths**

**MUTO Premium XL 80/150**

consisting of:  
 1 track profile, 1 cover profile,  
 1 counter profile  
 2 clamp carriers  
 (for 8–13.5 mm glass thickness)  
 with anti-jump mechanism  
 2 endstops with safety catch and anti jump device  
 1 floor guide  
 2 end caps  
 incl. brush profile  
 1 DORMOTION unit

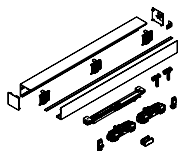

**max. 80 kg, incl. DORMOTION XL – 80**

36.506	850 mm clear opening width/910 mm panel width/1887 mm profile length	715,00	771,00	715,00	925,00	925,00
36.507	1050 mm clear opening width/1110 mm panel width/2287 mm profile length	814,00	886,00	814,00	1063,00	1063,00
36.508	1250 mm clear opening width/1310 mm panel width/2687 mm profile length	897,00	982,00	897,00	1179,00	1179,00

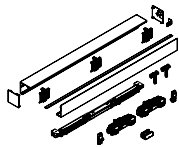

**max. 150 kg, incl. DORMOTION XL – 150**

36.513	1250 mm clear opening width/1310 mm panel width/2687 mm profile length	880,00	936,00	880,00	1123,00	1123,00
36.514	1400 mm clear opening width/1460 mm panel width/2987 mm profile length	946,00	1012,00	946,00	1216,00	1216,00

**Individual lengths**

**MUTO Premium XL 80/150**

consisting of:  
 1 track profile max. 5067 mm  
 1 cover profile max. 5067 mm  
 1 counter profile max. 5067 mm  
 2 clamp carriers  
 (for 8–13.5 mm glass thickness)  
 with anti-jump mechanism  
 2 endstops with safety catch and anti jump device  
 1 floor guide  
 2 end caps  
 incl. view protection brushes max. 5067 mm  
 1 DORMOTION unit

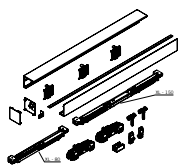

36.524	<b>max. 80 kg, incl. DORMOTION XL – 80</b> clear opening width min. 750 / max. 2440 mm panel width min. 810 / max. 2500 mm	Basic 1887 mm Surcharge per mm Max. 5067 mm	715,00	771,00	715,00	925,00	925,00
			0,30	0,30	0,30	0,40	0,40
36.525	<b>max. 150 kg, incl. DORMOTION XL – 150</b> clear opening min. 960 / max. 2440 mm panel width min. 1020 / max. 2500 mm	Basic 2687 mm Surcharge per mm Max. 5067 mm	880,00	936,00	880,00	1123,00	1123,00
			0,30	0,30	0,30	0,40	0,40

\* With assemblies in special color (399) the end caps will be delivered in plastic anthracite-grey solid-colored.



**Timber door (28–50 mm) double-leaf with glass overpanels and glass sidelights  
(optional with Synchro)**

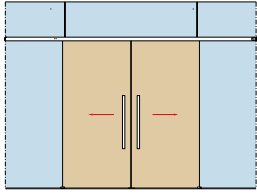

AL silver anod (150)	AL niro anod (157)	AL white p-coat (350)	AL special color anod (199)	AL special color p-coat (399) *
-------------------------------	-----------------------------	--------------------------------	---	--

Art. No.	Description	€/Piece	€/Piece	€/Piece	€/Piece	€/Piece
----------	-------------	---------	---------	---------	---------	---------

**Complete sets (inclusive DORMOTION, optional with Synchro)  
For Timber door application the adapter profile  
36.461 / 36.464 will be necessitated**

**Individual lengths**

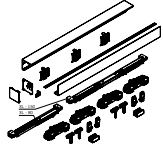



**MUTO Premium XL 80/150  
for two panels**

- consisting of:
- 1 track profile max. 5892 mm
- 1 cover profile max. 5892 mm
- 4 clamp carriers  
(for 8–13.5 mm glass thickness)
- with anti-jump mechanism
- 4 endstops with safety catch and anti jump device
- 2 floor guides
- 2 end caps
- incl. view protection brushes max. 5892 mm
- 2 DORMOTION units

<b>36.530</b>	<b>max. 80 kg</b> panel width min. 810 mm	Basic 3774 mm	<b>1431,00</b>	<b>1541,00</b>	<b>1431,00</b>	<b>1849,00</b>	<b>1849,00</b>
		Surcharge per mm Max. 5892 mm	<b>0,30</b>	<b>0,30</b>	<b>0,30</b>	<b>0,40</b>	<b>0,40</b>
<b>36.531</b>	<b>max. 150 kg</b> panel width min. 1020 mm	Basic 5374 mm	<b>1762,00</b>	<b>1871,00</b>	<b>1762,00</b>	<b>2246,00</b>	<b>2246,00</b>
		Surcharge per mm Max. 5892 mm	<b>0,30</b>	<b>0,30</b>	<b>0,30</b>	<b>0,40</b>	<b>0,40</b>

\* With assemblies in special color (399) the end caps will be delivered in plastic anthracite-grey solid-colored.

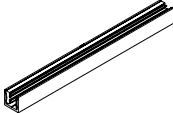
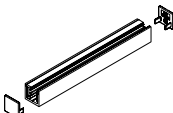
## Timber door (28–50 mm) double-leaf with glass overpanels and glass sidelights (optional with Synchro)

Art. No.	Description	Base parts (000)	AL silver anod (150)	AL niro anod (157)	AL white p-coat (350)	AL special color anod (199)	AL special color p-coat (399)	*
		€/Piece	€/Piece	€/Piece	€/Piece	€/Piece	€/Piece	€/Piece
<b>Single components</b>								
	<b>MUTO Premium XL 80/150 adapterprofile for timber panels</b> Profile 12,5 x 36 mm + 12,5 x 4 mm, incl. floor guide for timber panels, incl. accessories 1460 mm	<b>36.461</b>	<b>55,00</b> €/m					
	<b>36.464</b> in fixed length max. 2500 mm		<b>69,50</b>					
	<b>MUTO Floor profile</b> <b>incl. 2 end caps</b> for Comfort L, Premium XL and Premium Self-Closing for side panel fixing, complete with all gaskets, for 8–13,5 mm glass thickness stock length 6000 mm	<b>36.810</b>	<b>117,00</b> €/m	<b>134,00</b> €/m	<b>117,00</b> €/m	<b>161,00</b> €/m	<b>161,00</b> €/m	
	<b>36.811</b> in fixed length		<b>24,50</b>	<b>28,00</b>	<b>24,50</b>	<b>33,50</b>	<b>33,50</b>	
	<b>MUTO end caps (2 pcs.)</b> for Comfort L, Premium XL and Premium Self-Closing for floor profile - side panel fixing	<b>36.812</b>	<b>8,00</b>	<b>8,00</b>	<b>8,00</b>		<b>8,00</b>	
<b>Single components (optionally retrofittable)</b>								
	<b>MUTO Premium XL 80/150 Synchro-Set</b> for max. 80 kg consisting of: 1 elastic rope, 2 deflexion roller	<b>36.560</b>	<b>302,00</b>					

\* With assemblies in special color (399) the end caps will be delivered in plastic anthracite-grey solid-colored.

Notes

Sliding



# MUTO Premium Self-Closing 120



Technical data	
Glass	TSG, LSG (from 2 x TSG)
glass thickness	8-13,5 mm
Max. door weight	120 kg
Applications	single-leaf (glass or timber leaves), glass sidelights, at glass
Material	Aluminium
Finishes	Anodized- and RAL-Colors (coated)
Kind of installation	Wall, ceiling and at glass
Kind of installation	DORMOTION integrated locking mechanism and status indicator are optionally retrofittable Tested acc. DIN EN 1527 Height readjustable without dismantling +/-5 mm

Example view for MUTO Premium Self-Closing 120 installation at wall

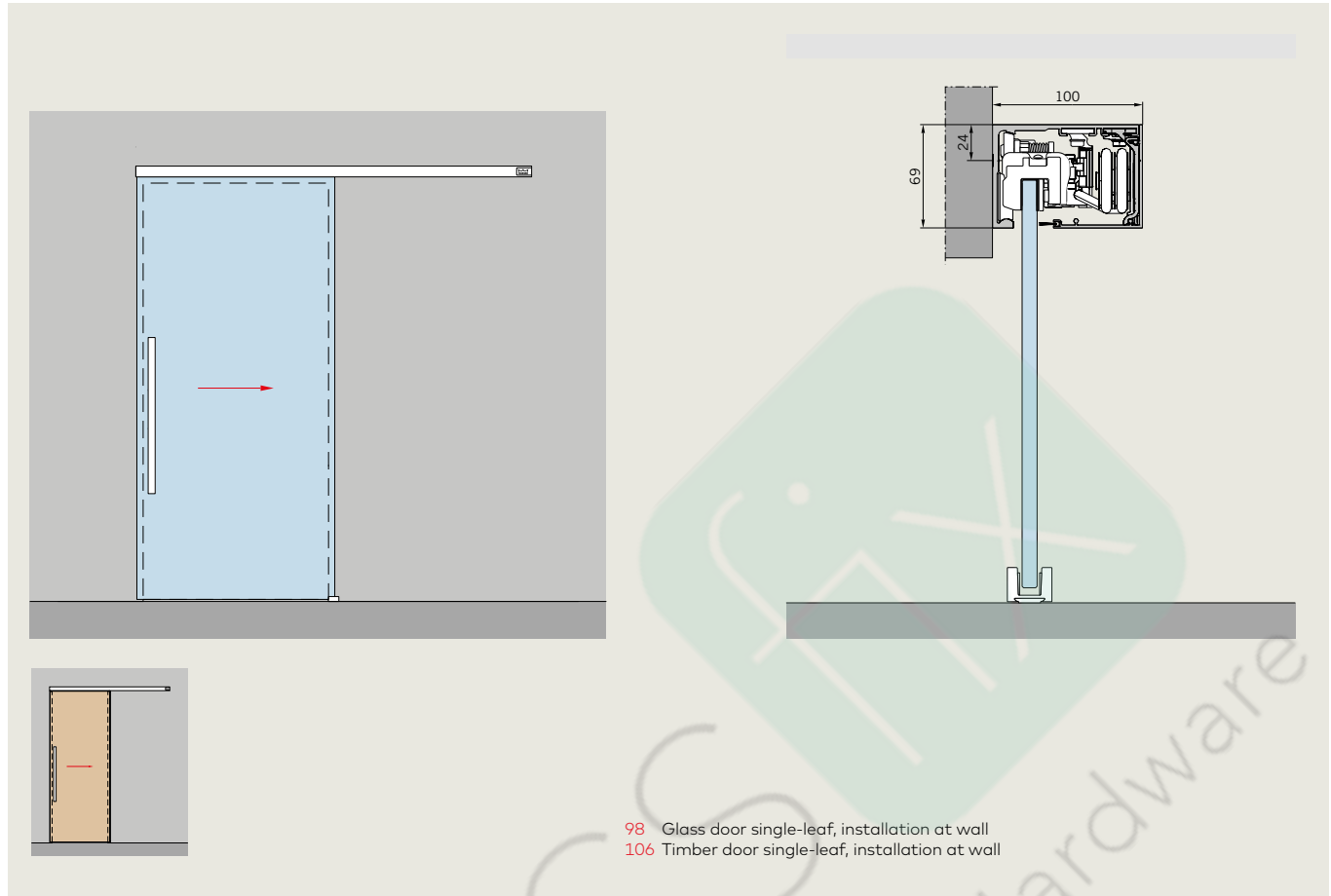

Example view for MUTO Premium Self-Closing 120 Installation at ceiling

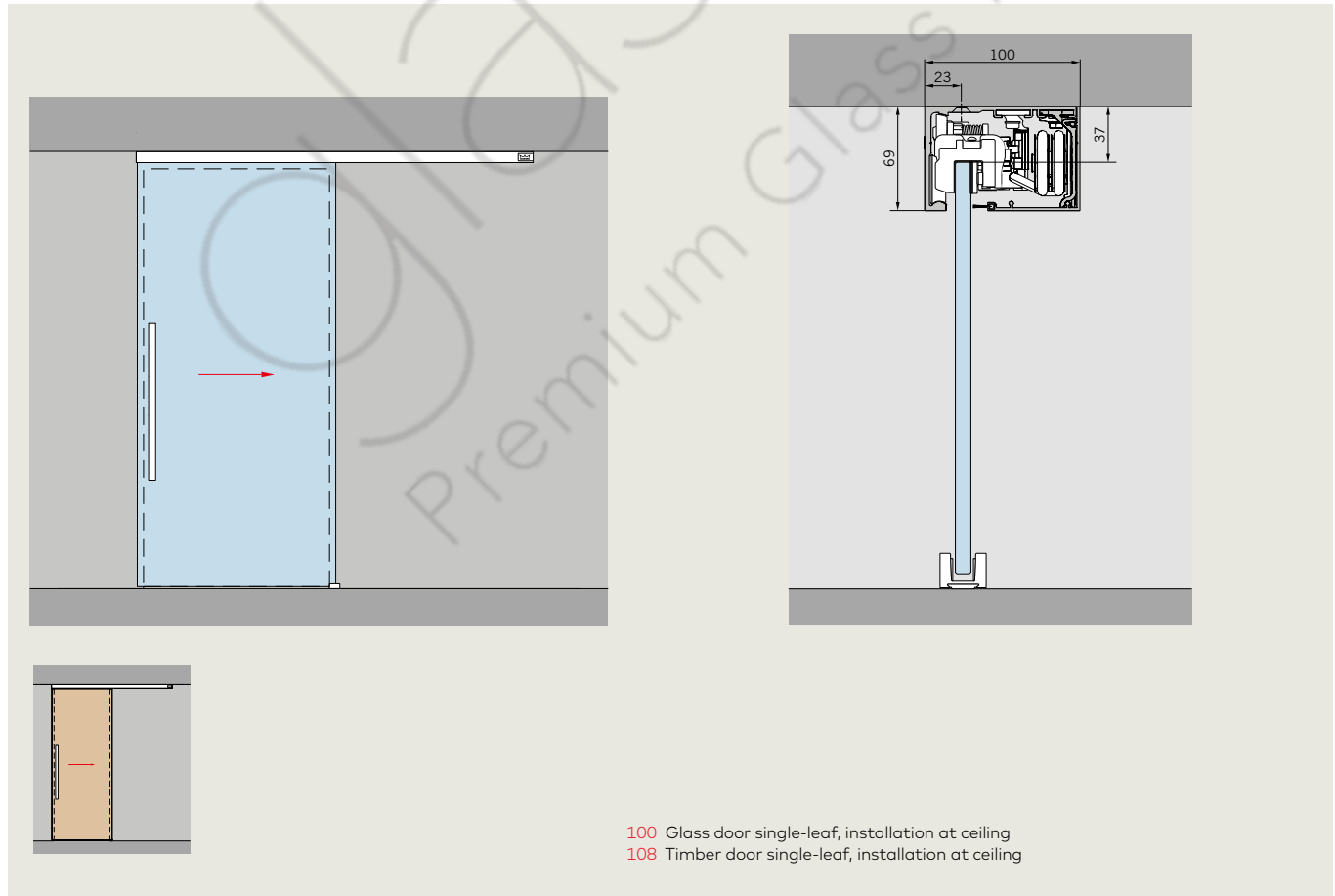



Example view for MUTO Premium Self-Closing 120 with glass sidelight/s

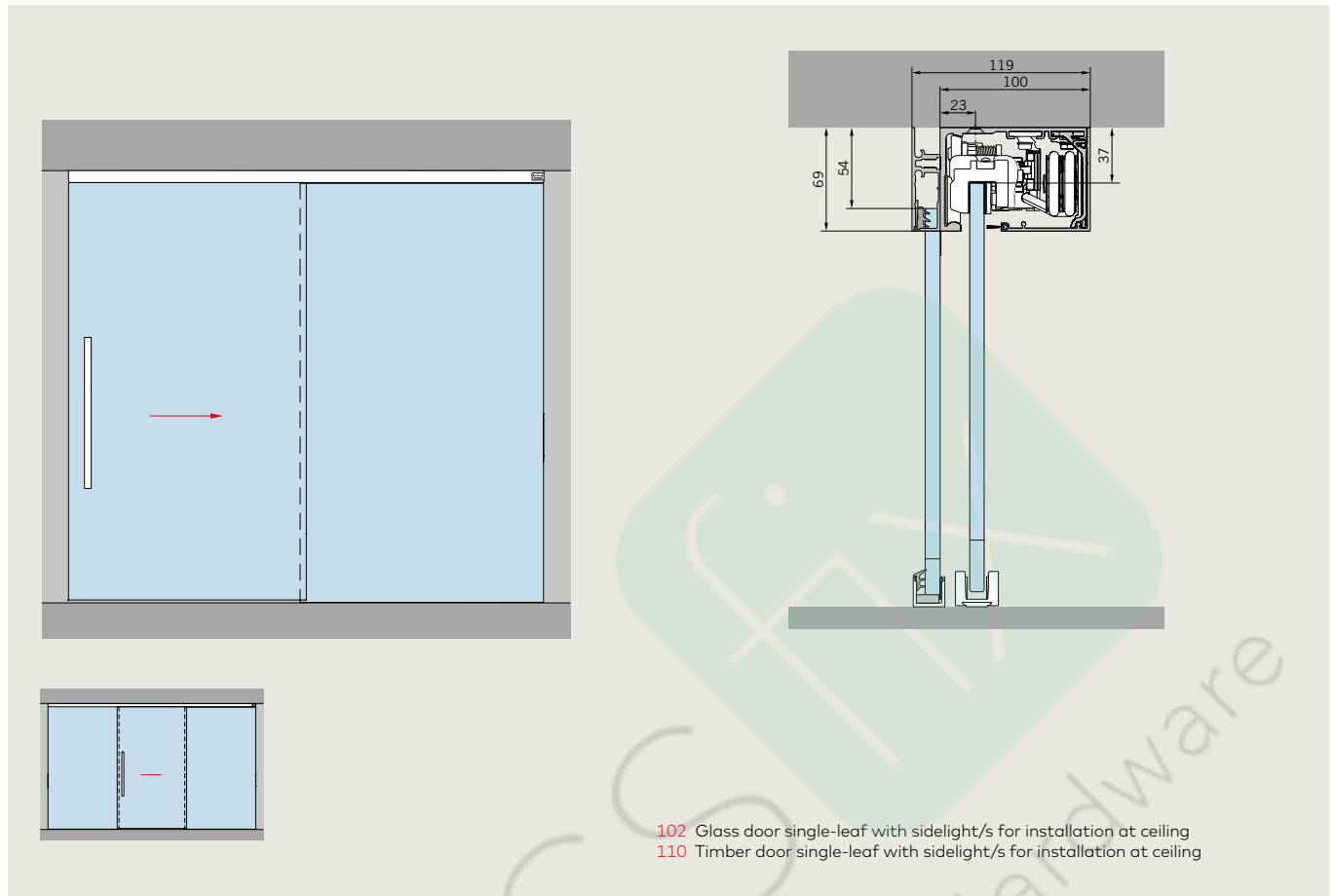

Sliding

Example view for MUTO Premium Self-Closing 120 with glass overpanel and glass sidelights

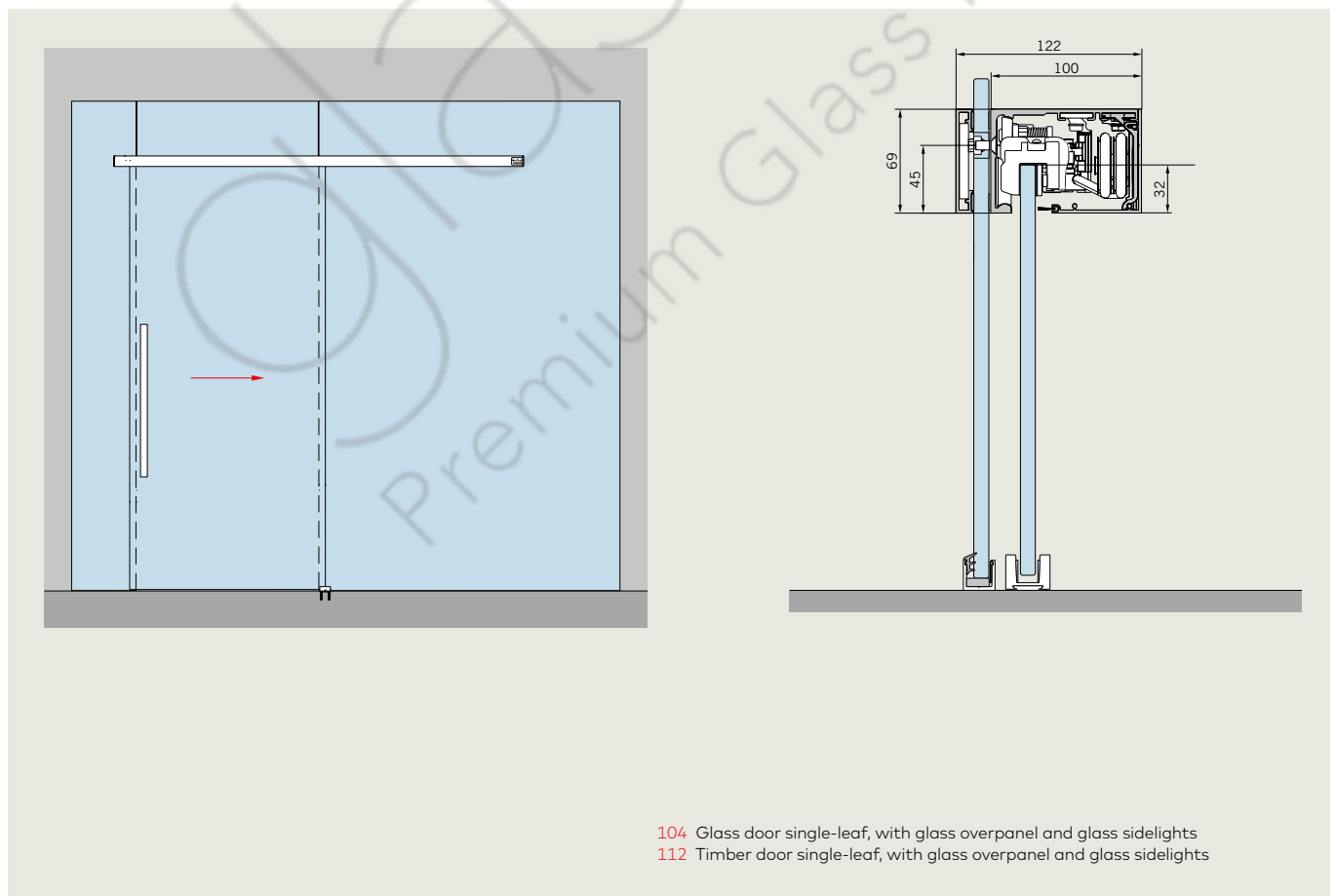

Glass door (8–13,5 mm) for installation at wall

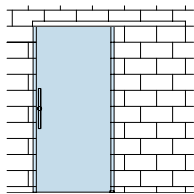

AL silver anod (150)	AL niro anod (157)	AL white p-coat (350)	AL special color anod (199)	AL special color p-coat (399) *
-------------------------------	-----------------------------	--------------------------------	---	--

Art. No.	Description	€/Piece	€/Piece	€/Piece	€/Piece	€/Piece
----------	-------------	---------	---------	---------	---------	---------

Complete sets

Defined lengths

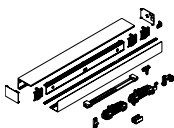

MUTO Premium Self-Closing 120

consisting of:  
 1 track profile  
 1 cover profile  
 2 clamp carriers  
 (for 8–13.5 mm glass thickness)  
 with anti-jump mechanism  
 2 endstops with safety catch and anti jump device  
 1 floor guide, 2 end caps  
 incl. view protection brushes  
 1 DORMOTION unit (one-sided)  
 1 elastic rope with accessories

for 950 mm panel width / 1880 mm profile length

36.600	Opening direction right, closing direction left (DIN left)	963,00	1009,00	963,00	1211,00	1211,00
36.601	Opening direction left, closing direction right (DIN right)	963,00	1009,00	963,00	1211,00	1211,00

for 1250 mm panel width / 2480 mm profile length

36.610	Opening direction right, closing direction left (DIN left)	1044,00	1104,00	1044,00	1305,00	1305,00
36.611	Opening direction left, closing direction right (DIN right)	1044,00	1104,00	1044,00	1305,00	1305,00

for 1450 mm panel width / 2880 mm profile length

36.602	Opening direction right, closing direction left (DIN left)	1101,00	1169,00	1101,00	1372,00	1372,00
36.603	Opening direction left, closing direction right (DIN right)	1101,00	1169,00	1101,00	1372,00	1372,00

Individual lengths

MUTO Premium Self-Closing 120

for max. 1500 mm panel width

consisting of:  
 1 track profile max. 3000 mm  
 1 cover profile max. 3000 mm  
 2 clamp carriers  
 (for 8–13.5 mm glass thickness)  
 with anti-jump mechanism  
 2 endstops with safety catch and anti jump device  
 1 floor guide, 2 end caps  
 incl. view protection brushes max. 3000 mm  
 1 DORMOTION unit (one-sided)  
 1 elastic rope with accessories

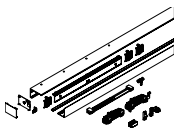

36.620	Opening direction right, closing direction left (DIN left)	Basic 1880 mm	963,00	1009,00	963,00	1211,00	1211,00
36.621	Opening direction left, closing direction right (DIN right)	Basic 1880 mm	963,00	1009,00	963,00	1211,00	1211,00
		Surcharge per mm	0,30	0,30	0,30	0,40	0,40
		Max. 3000 mm					

\* With assemblies in special color (399) the end caps will be delivered in plastic anthracite-grey solid-colored.



Glass door (8–13,5 mm) for installation at ceiling

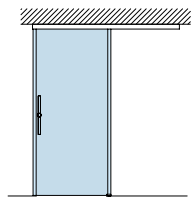

AL silver anod (150)	AL niro anod (157)	AL white p-coat (350)	AL special color anod (199)	AL special color p-coat (399)
----------------------	--------------------	-----------------------	-----------------------------	-------------------------------

\*

Art. No.	Description	€/Piece	€/Piece	€/Piece	€/Piece	€/Piece
----------	-------------	---------	---------	---------	---------	---------

Complete sets

Defined lengths

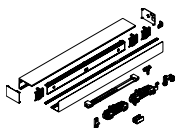

MUTO Premium Self-Closing 120

consisting of:  
 1 track profile  
 1 cover profile  
 2 clamp carriers (for 8–13.5 mm glass thickness) with anti-jump mechanism  
 2 endstops with safety catch and anti jump device  
 1 floor guide, 2 end caps incl. view protection brushes  
 1 DORMOTION unit (one-sided)  
 1 elastic rope with accessories

for 950 mm panel width / 1880 mm profile length

36.604	Opening direction right, closing direction left (DIN left)	963,00	1009,00	963,00	1211,00	1211,00
36.605	Opening direction left, closing direction right (DIN right)	963,00	1009,00	963,00	1211,00	1211,00

for 1250 mm panel width / 2480 mm profile length

36.612	Opening direction right, closing direction left (DIN left)	1044,00	1104,00	1044,00	1305,00	1305,00
36.613	Opening direction left, closing direction right (DIN right)	1044,00	1104,00	1044,00	1305,00	1305,00

for 1450 mm panel width / 2880 mm profile length

36.606	Opening direction right, closing direction left (DIN left)	1101,00	1169,00	1101,00	1372,00	1372,00
36.607	Opening direction left, closing direction right (DIN right)	1101,00	1169,00	1101,00	1372,00	1372,00

Individual lengths

MUTO Premium Self-Closing 120

for max. 1500 mm panel width



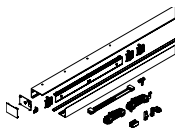

consisting of:  
 1 track profile max. 3000 mm  
 1 cover profile max. 3000 mm  
 2 clamp carriers (for 8–13.5 mm glass thickness) with anti-jump mechanism  
 2 endstops with safety catch and anti jump device  
 1 floor guide, 2 end caps  
 incl. view protection brushes max. 3000 mm  
 1 DORMOTION unit (one-sided)  
 1 elastic rope with accessories

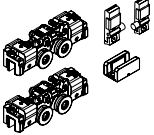

36.622	Opening direction right, closing direction left (DIN left)	Basic 1880 mm	963,00	1009,00	963,00	1211,00	1211,00
36.623	Opening direction left, closing direction right (DIN right)	Basic 1880 mm	963,00	1009,00	963,00	1211,00	1211,00
		Surcharge per mm	0,30	0,30	0,30	0,40	0,40
		Max. 3000 mm					

\* With assemblies in special color (399) the end caps will be delivered in plastic anthracite-grey solid-colored.

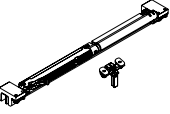
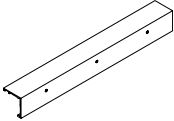
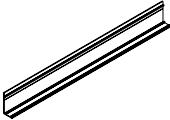
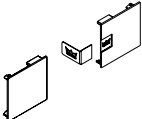
## Glass door (8–13,5 mm) for installation at ceiling

Art. No.	Description	Base parts (000)	AL silver anod (150)	AL niro anod (157)	AL white p-coat (350)	AL special color anod (199)	AL special color p-coat (399)	€ / Piece	€ / Piece	€ / Piece	€ / Piece	€ / Piece	€ / Piece
<b>Single components</b>													
	<b>36.550</b>	<b>MUTO Premium XL 80/150 accessories set</b> consisting of: 2 clamp carriers 2 endstops 1 floor guide						252,00	252,00				
		<b>MUTO Premium Self-Closing 120 elastic rope</b> with complete accessories						344,00					
	<b>36.657</b>	Opening to right side						344,00					
	<b>36.658</b>	Opening to left side											
		<b>MUTO Premium Self-Closing 120 DORMOTION-Set</b> for max. 120 kg, one-sided, with complete accessories						126,00					
	<b>36.660</b>	Opening direction right, closing direction left (DIN left)						126,00					
	<b>36.661</b>	Opening direction left, closing direction right (DIN right) min. panel width 830 mm max. panel width 1500 mm											
<b>Optional for additional cushioning in opening direction</b>													
	<b>36.666</b>	<b>MUTO Premium Self-Closing 120 optional cushioning unit for opening position</b> for max. 120 kg, one-sided on opening position for left and right opening direction with complete accessories						108,00					
<b>Single components</b>													
		<b>MUTO Premium Self-Closing 120 track profile for installation at ceiling</b> stock length 6000 mm						428,00	497,00	428,00	598,00	598,00	
	<b>36.852</b>							€/m	€/m	€/m	€/m	€/m	
	<b>36.653</b>	in fixed length						89,50	103,00	89,50	124,00	124,00	
		<b>MUTO Premium Self-Closing 120 cover profile</b> stock length 6000 mm						167,00	192,00	167,00	230,00	230,00	
	<b>36.854</b>							€/m	€/m	€/m	€/m	€/m	
	<b>36.655</b>	in fixed length						34,50	39,50	34,50	48,00	48,00	
		<b>MUTO Premium Self-Closing 120 end caps</b> for installation at wall and ceiling						11,50	11,50	11,50		11,50	
	<b>36.656</b>												
		<b>MUTO set of view protection brushes for Comfort M, L and Premium XL</b> consisting of: 1 view protection brush 8–10 mm glass thickness 1 view protection brush 12–13.5 mm glass thickness						€/m	9,80				
	<b>36.265</b>												

\* With assemblies in special color (399) the end caps will be delivered in plastic anthracite-grey solid-colored.

Glass door (8–13,5 mm) with glass sidelight/s

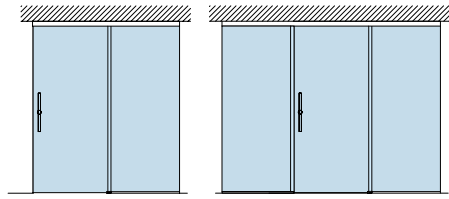

Base parts (000)	AL silver anod (150)	AL niro anod (157)	AL white p-coat (350)	AL special color anod (199)	AL special color p-coat (399)
					*

Art. No.	Description	€/Piece	€/Piece	€/Piece	€/Piece	€/Piece
----------	-------------	---------	---------	---------	---------	---------

Complete Sets

**MUTO Premium Self-Closing 120 for max. 1500 mm panel width**

consisting of:  
 1 track profile max. 3000 mm for sidelight connection  
 1 cover profile max. 3000 mm  
 1 sidelight profile max. 3000 mm  
 1 view protection profile depending on panel and sidelight  
 1 filling profile depending on panel and sidelight  
 2 clamp carriers (for 8–13.5 mm glass thickness) with anti-jump mechanism  
 2 endstops with safety catch and anti jump device  
 1 floor guide, 2 end caps  
 incl. view protection brushes max. 3000 mm  
 1 DORMOTION unit (one sided)  
 1 elastic rope with accessories

<b>36.629</b>	Opening direction right, closing direction left (DIN left)	Basic 1880 mm	1031,00	1088,00	1031,00	1303,00	1303,00
<b>36.630</b>	Opening direction left, closing direction right (DIN right)	Basic 1880 mm	1031,00	1088,00	1031,00	1303,00	1303,00
		Surcharge per mm	0,35	0,35	0,35	0,42	0,42
		Max. 3000 mm					

Single components

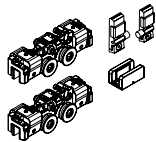

<b>36.550</b>	<b>MUTO Premium XL 80/150 accessories set</b> consisting of: 2 clamp carriers 2 endstops 1 floor guide	252,00	252,00				
---------------	--	--------	--------	--	--	--	--

**MUTO Premium Self-Closing 120 track profile for installation at ceiling**

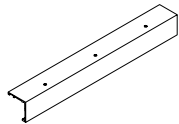

<b>36.852</b>	stock length 6000 mm	428,00	497,00	428,00	598,00	598,00
<b>36.653</b>	in fixed length	€/m	€/m	€/m	€/m	€/m
		89,50	103,00	89,50	124,00	124,00

**MUTO Premium Self-Closing 120 cover profile**

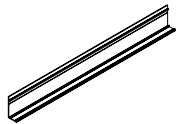

<b>36.854</b>	stock length 6000 mm	167,00	192,00	167,00	230,00	230,00
<b>36.655</b>	in fixed length	€/m	€/m	€/m	€/m	€/m
		34,50	39,50	34,50	48,00	48,00

**MUTO Premium Self-Closing 120 end caps for installation at wall and ceiling**

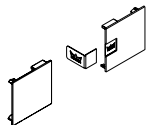

<b>36.656</b>		11,50	11,50	11,50		11,50
---------------	--	-------	-------	-------	--	-------

**MUTO Premium Self-Closing 120 elastic rope with complete accessories**

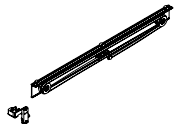

<b>36.657</b>	Opening to right side	344,00				
<b>36.658</b>	Opening to left side	344,00				

**MUTO set of view protection brushes for Comfort M, L and Premium XL**



<b>36.265</b>	consisting of: 1 view protection brush 8–10 mm glass thickness 1 view protection brush 12–13.5 mm glass thickness	€/m	9,50			
---------------	---	-----	------	--	--	--

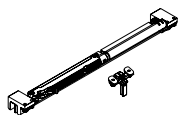

Single components (Mandatory necessary)

**MUTO Premium Self-Closing 120 DORMOTION-Set**

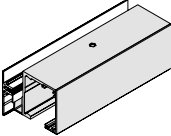
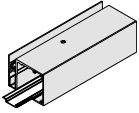
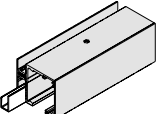

<b>36.660</b>	for max. 120 kg, one-sided, with complete accessories Opening direction right, closing direction left (DIN left)	126,00				
<b>36.661</b>	Opening direction left, closing direction right (DIN right) min. panel width 830 mm max. panel width 1500 mm	126,00				

## Glass door (8–13,5 mm) with glass sidelight/s

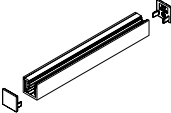
Art. No.	Description	AL silver anod (150)	AL niro anod (157)	AL white p-coat (350)	AL special color anod (199)	AL special color p-coat (399)
		€/m	€/m	€/m	€/m	€/m
<b>Single components</b>						
	<b>MUTO Premium XL 80/150 side panel profile, 69 mm height</b> with gaskets, for 8–13,5 mm glass stock length 6000 mm					
<b>36.469</b>		€/Piece	160,00	184,00	160,00	221,00
<b>36.474</b>	in fixed length		33,50	38,00	33,50	46,00
	<b>MUTO view protection profile</b> for Comfort L, Premium XL and Premium Self-Closing, for side panel profile stock length 6000 mm					
<b>36.800</b>		€/Piece	68,00	78,50	68,00	94,00
<b>36.801</b>	in fixed length		14,50	16,50	14,50	19,50
	<b>MUTO Filling profile</b> for Comfort L, Premium XL and Premium Self-Closing stock length 6000 mm					
<b>36.802</b>			68,00	78,50	68,00	94,00
<b>36.803</b>	in fixed length		14,50	16,50	14,50	19,50
	<b>MUTO Premium XL 80/150 end caps</b> for side panel profile, 69 mm height					
<b>36.471</b>		€/Piece	11,50	11,50	11,50	11,50
	<b>MUTO Floor profile</b> <b>incl. 2 end caps</b> for Comfort L, Premium XL and Premium Self-Closing for side panel fixing, complete with all gaskets, for 8–13,5 mm glass thickness stock length 6000 mm					
<b>36.810</b>		€/Piece	113,00	130,00	113,00	161,00
<b>36.811</b>	in fixed length		23,50	27,00	23,50	33,50
	<b>MUTO end caps (2 pcs.)</b> for Comfort L, Premium XL and Premium Self-Closing for floor profile – side panel fixing					
<b>36.812</b>		€/Piece	8,00	8,00	8,00	8,00

**Delivery status of side panel profile:**  
as part of complete sets = pre-drilled  
as single components = undrilled

\* With assemblies in special color (399) the end caps will be delivered in plastic anthracite-grey solid-colored.

Glass door (8–13,5 mm) with glass overpanel and glass sidelights

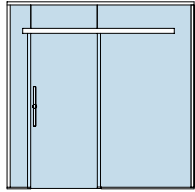

AL silver anod (150)	AL niro anod (157)	AL white p-coat (350)	AL special color anod (199)	AL special color p-coat (399)
				*

Art. No.	Description	€/Piece	€/Piece	€/Piece	€/Piece	€/Piece
----------	-------------	---------	---------	---------	---------	---------

Complete sets

Defined lengths

MUTO Premium Self-Closing 120

consisting of:  
 1 track profile  
 1 cover profile  
 2 clamp carriers  
 (for 8–13.5 mm glass thickness)  
 with anti-jump mechanism  
 2 endstops with safety catch and anti jump device  
 1 floor guide, 2 end caps  
 incl. view protection brushes  
 1 DORMOTION unit (one-sided)  
 1 elastic rope with accessories

850 mm clear opening w./910 mm panel width/1887 mm profile length

36.614	Opening direction right, closing direction left (DIN left)	1155,00	1210,00	1155,00	1452,00	1452,00
36.615	Opening direction left, closing direction right (DIN right)	1155,00	1210,00	1155,00	1452,00	1452,00

1050 mm clear opening w./1110 mm panel width/2287 mm profile length

36.616	Opening direction right, closing direction left (DIN left)	1202,00	1265,00	1202,00	1507,00	1507,00
36.617	Opening direction left, closing direction right (DIN right)	1202,00	1265,00	1202,00	1507,00	1507,00

1250 mm clear opening w./1310 mm panel width/2687 mm profile length

36.608	Opening direction right, closing direction left (DIN left)	1289,00	1366,00	1289,00	1609,00	1609,00
36.609	Opening direction left, closing direction right (DIN right)	1289,00	1366,00	1289,00	1609,00	1609,00

Individual lengths

MUTO Premium Self-Closing 120 for max. 1500 mm panel width

consisting of:  
 1 track profile max. 3067 mm  
 1 cover profile max. 3067 mm  
 1 counter profile 3067 mm  
 2 clamp carriers  
 (for 8–13.5 mm glass thickness)  
 with anti-jump mechanism  
 2 endstops with safety catch and anti jump device  
 1 floor guide, 2 end caps  
 incl. view protection brushes max. 3067 mm  
 1 DORMOTION unit (one-sided)  
 1 elastic rope with accessories

36.624	Opening direction right, closing direction left (DIN left)	Basic 2687 mm 1155,00	Basic 2687 mm 1210,00	Basic 2687 mm 1155,00	Basic 2687 mm 1452,00	Basic 2687 mm 1452,00
36.625	Opening direction left, closing direction right (DIN right)	Basic 2687 mm 1155,00	Basic 2687 mm 1210,00	Basic 2687 mm 1155,00	Basic 2687 mm 1452,00	Basic 2687 mm 1452,00
		Surcharge per mm 0,30	Surcharge per mm 0,30	Surcharge per mm 0,30	Surcharge per mm 0,40	Surcharge per mm 0,40
		Max. 3067 mm				

\* With assemblies in special color (399) the end caps will be delivered in plastic anthracite-grey solid-colored.



## Glass door (8–13,5 mm) with glass overpanel and glass sidelights

AL silver anod (150)	AL niro anod (157)	AL white p-coat (350)	AL special color anod (199)	AL special color p-coat (399) *
-------------------------------	-----------------------------	--------------------------------	---	--

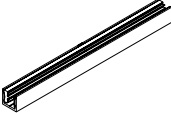
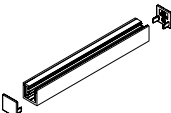
Art. No.	Description	€/Piece	€/Piece	€/Piece	€/Piece	€/Piece
<b>Single components</b>						
	<b>MUTO Floor profile incl. 2 end caps</b> for Comfort L, Premium XL and Premium Self-Closing for side panel fixing, complete with all gaskets, for 8–13,5 mm glass thickness stock length 6000 mm					
	<b>36.810</b>	117,00	134,00	117,00	161,00	161,00
		€/m	€/m	€/m	€/m	€/m
	<b>36.811</b> in fixed length	24,50	28,00	24,50	33,50	33,50
	<b>36.812</b> <b>MUTO end caps (2 pcs.)</b> for Comfort L, Premium XL and Premium Self-Closing for floor profile - side panel fixing	8,00	8,00	8,00		8,00

\* With assemblies in special color (399) the end caps will be delivered in plastic anthracite-grey solid-colored.

Timber door (28–50 mm) for installation at wall

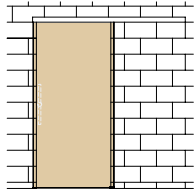

AL silver anod (150)	AL niro anod (157)	AL white p-coat (350)	AL special color anod (199)	AL special color p-coat (399)
				*

Art. No.	Description	€/Piece	€/Piece	€/Piece	€/Piece	€/Piece
----------	-------------	---------	---------	---------	---------	---------

**Complete sets**  
For Timber door application the adapter profile  
36.461 / 36.464 will be necessitated

**Defined lengths**

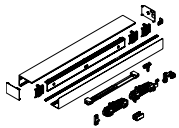

**MUTO Premium Self-Closing 120**

consisting of:  
1 track profile  
1 cover profile  
2 clamp carriers  
(for 8–13.5 mm glass thickness)  
with anti-jump mechanism  
2 endstops with safety catch and anti jump device  
1 floor guide, 2 end caps  
incl. view protection brushes  
1 DORMOTION unit (one-sided)  
1 elastic rope with accessories

**for 950 mm panel width / 1880 mm profile length**

36.600	Opening direction right, closing direction left (DIN left)	963,00	1009,00	963,00	1211,00	1211,00
36.601	Opening direction left, closing direction right (DIN right)	963,00	1009,00	963,00	1211,00	1211,00

**for 1250 mm panel width / 2480 mm profile length**

36.610	Opening direction right, closing direction left (DIN left)	1044,00	1104,00	1044,00	1305,00	1305,00
36.611	Opening direction left, closing direction right (DIN right)	1044,00	1104,00	1044,00	1305,00	1305,00

**for 1450 mm panel width / 2880 mm profile length**

36.602	Opening direction right, closing direction left (DIN left)	1101,00	1169,00	1101,00	1372,00	1372,00
36.603	Opening direction left, closing direction right (DIN right)	1101,00	1169,00	1101,00	1372,00	1372,00

**Individual lengths**

**MUTO Premium Self-Closing 120  
for max. 1500 mm panel width**

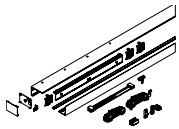

consisting of:  
1 track profile max. 3000 mm  
1 cover profile max. 3000 mm  
2 clamp carriers  
(for 8–13.5 mm glass thickness)  
with anti-jump mechanism  
2 endstops with safety catch and anti jump device  
1 floor guide, 2 end caps  
incl. view protection brushes max. 3000 mm  
1 DORMOTION unit (one-sided)  
1 elastic rope with accessories



36.620	Opening direction right, closing direction left (DIN left)	Basic 1880 mm	963,00	1009,00	963,00	1211,00	1211,00
36.621	Opening direction left, closing direction right (DIN right)	Basic 1880 mm	963,00	1009,00	963,00	1211,00	1211,00
		Surcharge per mm	0,30	0,30	0,30	0,40	0,40
		Max. 3000 mm					

\* With assemblies in special color (399) the end caps will be delivered in plastic anthracite-grey solid-colored.

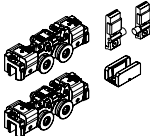
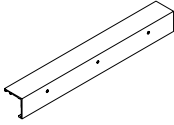
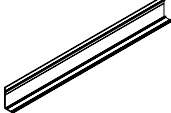
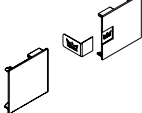
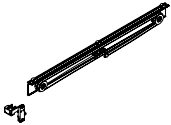
## Timber door (28–50 mm) for installation at wall

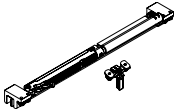
Art. No.	Description	Base parts (000)	AL silver anod (150)	AL niro anod (157)	AL white p-coat (350)	AL special color anod (199)	AL special color p-coat (399)	*
		€/Piece	€/Piece	€/Piece	€/Piece	€/Piece	€/Piece	€/Piece
<b>Single components</b>								
	<b>MUTO Premium XL 80/150 adapterprofile for timber panels</b> Profile 12,5 x 36 mm + 12,5 x 4 mm, incl. floor guide for timber panels, incl. accessories 1460 mm		55,00 €/m					
	36.461							
	36.464		69,50					
	<b>MUTO Premium XL 80/150 accessories set</b> consisting of: 2 clamp carriers 2 endstops 1 floor guide			252,00	252,00			
	36.550							
	<b>MUTO Premium Self-Closing 120 track profile for installation at wall</b> stock length 6000 mm		428,00 €/m	497,00 €/m	428,00 €/m	598,00 €/m	598,00 €/m	
	36.850							
	36.651		89,50	103,00	89,50	124,00	124,00	
	<b>MUTO Premium Self-Closing 120 cover profile</b> stock length 6000 mm		167,00 €/m	192,00 €/m	167,00 €/m	230,00 €/m	230,00 €/m	
	36.854							
	36.655		34,50	39,50	34,50	48,00	48,00	
	<b>MUTO Premium Self-Closing 120 end caps</b> for installation at wall and ceiling		11,50	11,50	11,50		11,50	
	36.656							
	<b>MUTO Premium Self-Closing 120 elastic rope</b> with complete accessories Opening to right side							344,00
	36.657							
	36.658							344,00
	<b>MUTO set of view protection brushes for Comfort M, L and Premium XL</b> consisting of: 1 view protection brush 8–10 mm glass thickness 1 view protection brush 12–13.5 mm glass thickness		9,80 €/m					
	36.265							
<b>Single components (Mandatory necessary)</b>								
	<b>MUTO Premium Self-Closing 120 DORMOTION-Set</b> for max. 120 kg, one-sided, with complete accessories Opening direction right, closing direction left (DIN left)							126,00
	36.660							
	36.661							126,00

\* With assemblies in special color (399) the end caps will be delivered in plastic anthracite-grey solid-colored.

Timber door (28–50 mm) for installation at ceiling

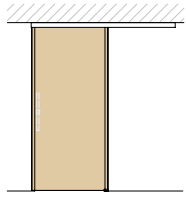

AL silver anod (150)	AL niro anod (157)	AL white p-coat (350)	AL special color anod (199)	AL special color p-coat (399)
				*

Art. No.	Description	€/Piece	€/Piece	€/Piece	€/Piece	€/Piece
----------	-------------	---------	---------	---------	---------	---------

**Complete sets**  
For Timber door application the adapter profile  
36.461 / 36.464 will be necessitated

**Defined lengths**

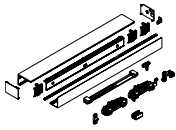

**MUTO Premium Self-Closing 120**  
consisting of:  
1 track profile  
1 cover profile  
2 clamp carriers  
(for 8–13.5 mm glass thickness)  
with anti-jump mechanism  
2 endstops with safety catch and anti jump device  
1 floor guide, 2 end caps  
incl. view protection brushes  
1 DORMOTION unit (one-sided)  
1 elastic rope with accessories

**for 950 mm panel width / 1880 mm profile length**

36.604	Opening direction right, closing direction left (DIN left)	963,00	1009,00	963,00	1211,00	1211,00
36.605	Opening direction left, closing direction right (DIN right)	963,00	1009,00	963,00	1211,00	1211,00

**for 1250 mm panel width / 2480 mm profile length**

36.612	Opening direction right, closing direction left (DIN left)	1044,00	1104,00	1044,00	1305,00	1305,00
36.613	Opening direction left, closing direction right (DIN right)	1044,00	1104,00	1044,00	1305,00	1305,00

**for 1450 mm panel width / 2880 mm profile length**

36.606	Opening direction right, closing direction left (DIN left)	1101,00	1169,00	1101,00	1372,00	1372,00
36.607	Opening direction left, closing direction right (DIN right)	1101,00	1169,00	1101,00	1372,00	1372,00

**Individual lengths**

**MUTO Premium Self-Closing 120**  
**for max. 1500 mm panel width**  
consisting of:  
1 track profile max. 3000 mm  
1 cover profile max. 3000 mm  
2 clamp carriers  
(for 8–13.5 mm glass thickness)  
with anti-jump mechanism  
2 endstops with safety catch and anti jump device  
1 floor guide, 2 end caps  
incl. view protection brushes max. 3000 mm  
1 DORMOTION unit (one-sided)  
1 elastic rope with accessories

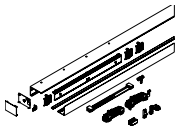

36.622	Opening direction right, closing direction left (DIN left)	963,00	1009,00	963,00	1211,00	1211,00
36.623	Opening direction left, closing direction right (DIN right)	963,00	1009,00	963,00	1211,00	1211,00
	Basic 1880 mm					
	Basic 1880 mm	0,30	0,30	0,30	0,40	0,40
	Surcharge per mm					
	Max. 3000 mm					

\* With assemblies in special color (399) the end caps will be delivered in plastic anthracite-grey solid-colored.

## Timber door (28–50 mm) for installation at ceiling

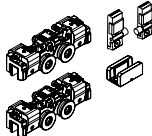
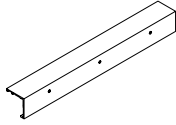
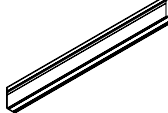
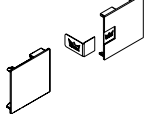
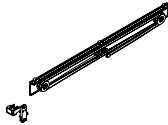
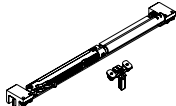
Art. No.	Description	Base parts (000)	AL silver anod (150)	AL niro anod (157)	AL white p-coat (350)	AL special color anod (199)	AL special color p-coat (399)	*
		€/Piece	€/Piece	€/Piece	€/Piece	€/Piece	€/Piece	€/Piece
<b>Single components</b>								
	<b>MUTO Premium XL 80/150 adapterprofile for timber panels</b> Profile 12,5 x 36 mm + 12,5 x 4 mm, incl. floor guide for timber panels, incl. accessories 1460 mm	55,00 €/m						
36.461		69,50						
36.464	in fixed length max. 2500 mm							
	<b>MUTO Premium XL 80/150 accessories set</b> consisting of: 2 clamp carriers 2 endstops 1 floor guide		252,00	252,00				
36.550								
	<b>MUTO Premium Self-Closing 120 track profile for installation at ceiling</b> stock length 6000 mm	428,00 €/m	497,00 €/m	428,00 €/m	598,00 €/m	598,00 €/m		
36.852		89,50	103,00	89,50	124,00	124,00		
36.653	in fixed length							
	<b>MUTO Premium Self-Closing 120 cover profile</b> stock length 6000 mm	167,00 €/m	192,00 €/m	167,00 €/m	230,00 €/m	230,00 €/m		
36.854		34,50	39,50	34,50	48,00	48,00		
36.655	in fixed length							
	<b>MUTO Premium Self-Closing 120 end caps</b> for installation at wall and ceiling		11,50	11,50	11,50		11,50	
36.656								
	<b>MUTO Premium Self-Closing 120 elastic rope</b> with complete accessories	344,00						
36.657	Opening to right side	344,00						
36.658	Opening to left side							
		€/m						
36.265	<b>MUTO set of view protection brushes for Comfort M, L and Premium XL</b> consisting of: 1 view protection brush 8–10 mm glass thickness 1 view protection brush 12–13.5 mm glass thickness	9,80						
	<b>MUTO Premium Self-Closing 120 DORMOTION-Set</b> for max. 120 kg, one-sided, with complete accessories	126,00						
36.660	Opening direction right, closing direction left (DIN left)	126,00						
36.661	Opening direction left, closing direction right (DIN right)							
	min. panel width 830 mm max. panel width 1500 mm							

\* With assemblies in special color (399) the end caps will be delivered in plastic anthracite-grey solid-colored.

Timber door (28–50 mm) with glass sidelight/s

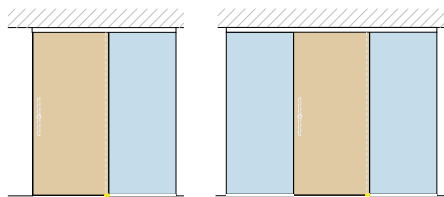

Base parts (000)	AL silver anod (150)	AL niro anod (157)	AL white p-coat (350)	AL special color anod (199)	AL special color p-coat (399)
					*

Art. No.	Description	€/Piece	€/Piece	€/Piece	€/Piece	€/Piece
----------	-------------	---------	---------	---------	---------	---------

**Single components**  
For Timber door application the adapter profile 36.461 / 36.464 will be necessitated

**MUTO Premium XL 80/150 adapterprofile for timber panels**

Profile 12,5 x 36 mm + 12,5 x 4 mm, incl. floor guide for timber panels, incl. accessories 1460 mm



36.461		55,00				
		€/m				
36.464	in fixed length max. 2500 mm	69,50				

**MUTO Premium XL 80/150 accessories set**

consisting of:  
2 clamp carriers  
2 endstops  
1 floor guide

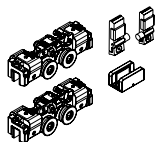

36.550			252,00	252,00		
--------	--	--	--------	--------	--	--

**MUTO Premium Self-Closing 120 track profile for installation at ceiling**

stock length 6000 mm

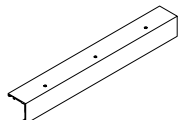

36.852		428,00	497,00	428,00	598,00	598,00
		€/m	€/m	€/m	€/m	€/m
36.653	in fixed length	89,50	103,00	89,50	124,00	124,00

**MUTO Premium Self-Closing 120 cover profile**

stock length 6000 mm

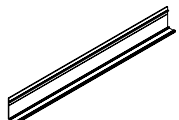

36.854		167,00	192,00	167,00	230,00	230,00
		€/m	€/m	€/m	€/m	€/m
36.655	in fixed length	34,50	39,50	34,50	48,00	48,00

**MUTO Premium Self-Closing 120 end caps**

for installation at wall and ceiling

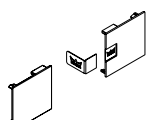

36.656		11,50	11,50	11,50		11,50
--------	--	-------	-------	-------	--	-------

**MUTO Premium Self-Closing 120 elastic rope**

with complete accessories

Opening to right side

Opening to left side

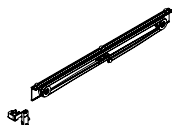

36.657		344,00				
36.658		344,00				

**MUTO set of view protection brushes for Comfort M, L and Premium XL**

consisting of:  
1 view protection brush 8–10 mm glass thickness  
1 view protection brush 12–13.5 mm glass thickness



36.265		€/m	9,80			
--------	--	-----	------	--	--	--

**Single components (Mandatory necessary)**

**MUTO Premium Self-Closing 120 DORMOTION-Set**

for max. 120 kg, one-sided, with complete accessories

Opening direction right, closing direction left (DIN left)

Opening direction left, closing direction right (DIN right)

min. panel width 830 mm

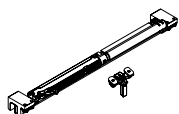

max. panel width 1500 mm



36.660		126,00				
36.661		126,00				

\* With assemblies in special color (399) the end caps will be delivered in plastic anthracite-grey solid-colored.

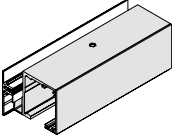
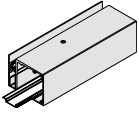
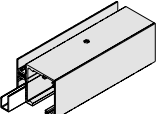
## Timber door (28–50 mm) with glass sidelight/s

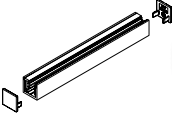
Art. No.	Description	Base parts (000)	AL silver anod (150)	AL niro anod (157)	AL white p-coat (350)	AL special color anod (199)	AL special color p-coat (399)	*
		€/m	€/m	€/m	€/m	€/m	€/m	€/m
<b>Single components</b>								
	<b>MUTO Premium XL 80/150 side panel profile, 69 mm height</b> with gaskets, for 8–13,5 mm glass stock length 6000 mm	€/Piece	160,00	184,00	160,00	221,00	221,00	
36.469	in fixed length		33,50	38,00	33,50	46,00	46,00	
36.474								
	<b>MUTO view protection profile</b> for Comfort L, Premium XL and Premium Self-Closing, for side panel profile stock length 6000 mm	€/Piece	68,00	78,50	68,00	94,00	94,00	
36.800	in fixed length		14,50	16,50	14,50	19,50	19,50	
36.801								
	<b>MUTO Filling profile</b> for Comfort L, Premium XL and Premium Self-Closing stock length 6000 mm	€/Piece	68,00	78,50	68,00	94,00	94,00	
36.802	in fixed length		14,50	16,50	14,50	19,50	19,50	
36.803								
	<b>MUTO Premium XL 80/150 end caps</b> for side panel profile, 69 mm height	€/Piece	11,50	11,50	11,50			11,50
36.471								
	<b>MUTO Floor profile</b> <b>incl. 2 end caps</b> for Comfort L, Premium XL and Premium Self-Closing for side panel fixing, complete with all gaskets, for 8–13,5 mm glass thickness stock length 6000 mm	€/Piece	117,00	134,00	117,00	161,00	161,00	
36.810	in fixed length		24,50	28,00	24,50	33,50	33,50	
36.811								
	<b>MUTO end caps (2 pcs.)</b> for Comfort L, Premium XL and Premium Self-Closing for floor profile – side panel fixing	€/Piece	8,00	8,00	8,00			8,00
36.812								

**Delivery status of side panel profile:**  
as part of complete sets = pre-drilled  
as single components = undrilled

\* With assemblies in special color (399) the end caps will be delivered in plastic anthracite-grey solid-colored.

Timber door (28–50 mm) with glass overpanel and glass sidelights

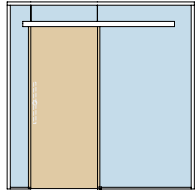

AL silver anod (150)	AL niro anod (157)	AL white p-coat (350)	AL special color anod (199)	AL special color p-coat (399)
				*

Art. No.	Description	€/Piece	€/Piece	€/Piece	€/Piece	€/Piece
----------	-------------	---------	---------	---------	---------	---------

**Complete sets**  
**For Timber door application the adapter profile 36.461 / 36.464 will be necessitated**

**Defined lengths**

**MUTO Premium Self-Closing 120**

consisting of:  
 1 track profile  
 1 cover profile  
 2 clamp carriers (for 8–13.5 mm glass thickness) with anti-jump mechanism  
 2 endstops with safety catch and anti jump device  
 1 floor guide, 2 end caps  
 incl. view protection brushes  
 1 DORMOTION unit (one-sided)  
 1 elastic rope with accessories

<b>850 mm clear opening w./910 mm panel width/1887 mm profile length</b>		€/Piece	€/Piece	€/Piece	€/Piece	€/Piece
<b>36.614</b>	Opening direction right, closing direction left (DIN left)	1155,00	1210,00	1155,00	1452,00	1452,00
<b>36.615</b>	Opening direction left, closing direction right (DIN right)	1155,00	1210,00	1155,00	1452,00	1452,00
<b>1050 mm clear opening w./1110 mm panel width/2287 mm profile length</b>		€/Piece	€/Piece	€/Piece	€/Piece	€/Piece
<b>36.616</b>	Opening direction right, closing direction left (DIN left)	1202,00	1265,00	1202,00	1507,00	1507,00
<b>36.617</b>	Opening direction left, closing direction right (DIN right)	1202,00	1265,00	1202,00	1507,00	1507,00
<b>1250 mm clear opening w./1310 mm panel width/2687 mm profile length</b>		€/Piece	€/Piece	€/Piece	€/Piece	€/Piece
<b>36.608</b>	Opening direction right, closing direction left (DIN left)	1289,00	1366,00	1289,00	1609,00	1609,00
<b>36.609</b>	Opening direction left, closing direction right (DIN right)	1289,00	1366,00	1289,00	1609,00	1609,00

**Individual lengths**

**MUTO Premium Self-Closing 120 for max. 1500 mm panel width**

consisting of:  
 1 track profile max. 3067 mm  
 1 cover profile max. 3067 mm  
 1 counter profile 3067 mm  
 2 clamp carriers (for 8–13.5 mm glass thickness) with anti-jump mechanism  
 2 endstops with safety catch and anti jump device  
 1 floor guide, 2 end caps  
 incl. view protection brushes max. 3067 mm  
 1 DORMOTION unit (one-sided)  
 1 elastic rope with accessories

		Basic 2687 mm	Basic 2687 mm	Surcharge per mm	Max. 3067 mm
<b>36.624</b>	Opening direction right, closing direction left (DIN left)	1289,00	1366,00	1289,00	1609,00
<b>36.625</b>	Opening direction left, closing direction right (DIN right)	1289,00	1366,00	1289,00	1609,00
		0,30	0,30	0,30	0,40

\* With assemblies in special color (399) the end caps will be delivered in plastic anthracite-grey solid-colored.

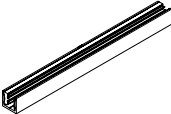
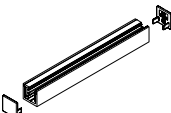

## Timber door (28–50 mm) with glass overpanel and glass sidelights

Art. No.	Description	Base parts (000)	AL silver anod (150)	AL niro anod (157)	AL white p-coat (350)	AL special color anod (199)	AL special color p-coat (399)	*
		€/Piece	€/Piece	€/Piece	€/Piece	€/Piece	€/Piece	
<b>Single components</b>								
	<b>MUTO Premium XL 80/150 adapterprofile for timber panels</b> Profile 12,5 x 36 mm + 12,5 x 4 mm, incl. floor guide for timber panels, incl. accessories 1460 mm		55,00 €/m					
36.461								
36.464	in fixed length max. 2500 mm		69,50					
	<b>MUTO Floor profile</b> <b>incl. 2 end caps</b> for Comfort L, Premium XL and Premium Self-Closing for side panel fixing, complete with all gaskets, for 8–13,5 mm glass thickness stock length 6000 mm		117,00 €/m	134,00 €/m	117,00 €/m	161,00 €/m	161,00 €/m	
36.810								
36.811	in fixed length		24,50	28,00	24,50	33,50	33,50	
	<b>MUTO end caps (2 pcs.)</b> for Comfort L, Premium XL and Premium Self-Closing for floor profile - side panel fixing		8,00	8,00	8,00		8,00	
36.812								

\* With assemblies in special color (399) the end caps will be delivered in plastic anthracite-grey solid-colored.

Notes

Sliding



# MUTO Premium Telescopic 80



Technical data	
Glasart	TSG, LSG (from 2 x TSG)
glass thickness	8-13,5 mm
Max. Türflügelgewicht	80 kg (per panel)
Anwendungen	single-leaf, double-leaf, (glass or timber leaves), glass sidelights, at glass
Material	Aluminium
Oberflächen	Anodized- and RAL-Colors (coated)
Montageart	Wall, ceiling and at glass
Ihre Vorteile	DORMOTION (optionally retrofittable) integrated locking mechanism and status indicator are optionally retrofittable Tested acc. DIN EN 1527 Height readjustable without dismantling + 5 mm/-3mm

Example view for MUTO Premium Telescopic 80 installation at wall

Sliding

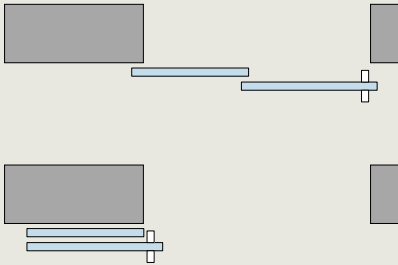
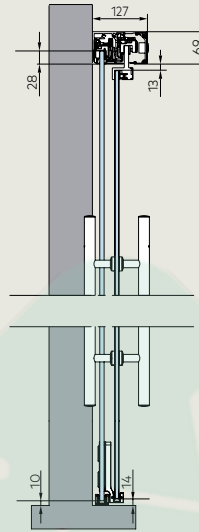
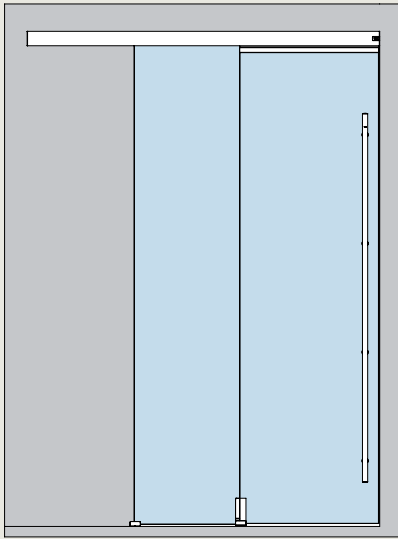

	Set No.	Page
Glass door for installation at wall	1 / 1.1 / 2 / 2.2 / 3	118
	13 / 13.1 / 14 / 14.1 / 15	122
Timber door for installation at wall	25 / 25.1 / 26 / 26.1 / 27	126

Example view for MUTO Premium Telescopic 80 installation at ceiling

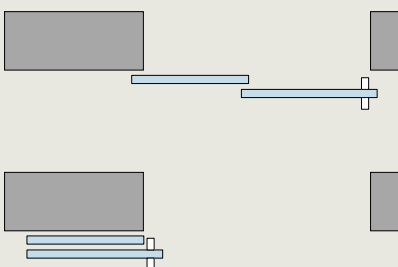
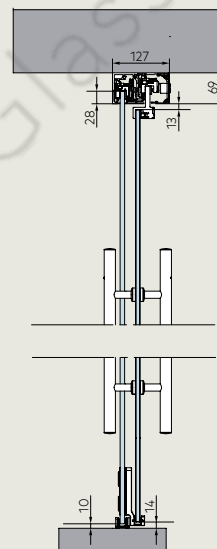
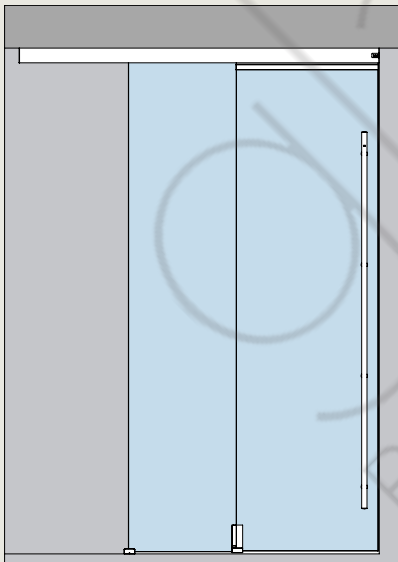

	Set No.	Page
Glass door for installation at ceiling	4 / 4.1 / 6	119
	7 / 7.1	120
	16 / 16.1 / 18	123
	19 / 19.1	124
Timber door for installation at ceiling	28 / 28.1 / 30	127
	31 / 31.1	128

**Example view for MUTO Premium Telescopic 80 installation at ceiling with glass sidelight**

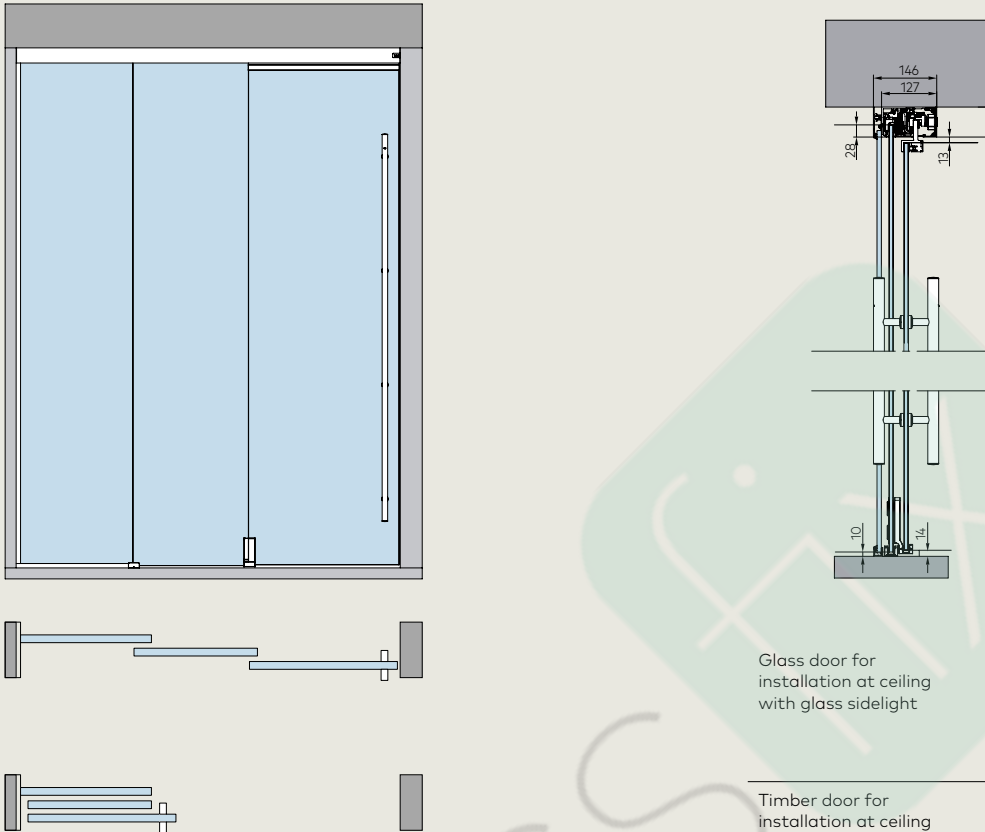

	Set No.	Page
Glass door for installation at ceiling with glass sidelight	5	119
	8 / 9	120
	17	123
	20 / 21	124
Timber door for installation at ceiling with glass sidelight	29	127
	32 / 33	128

**Example view for MUTO Premium Telescopic 80 with glass overpanel and glass sidelight**

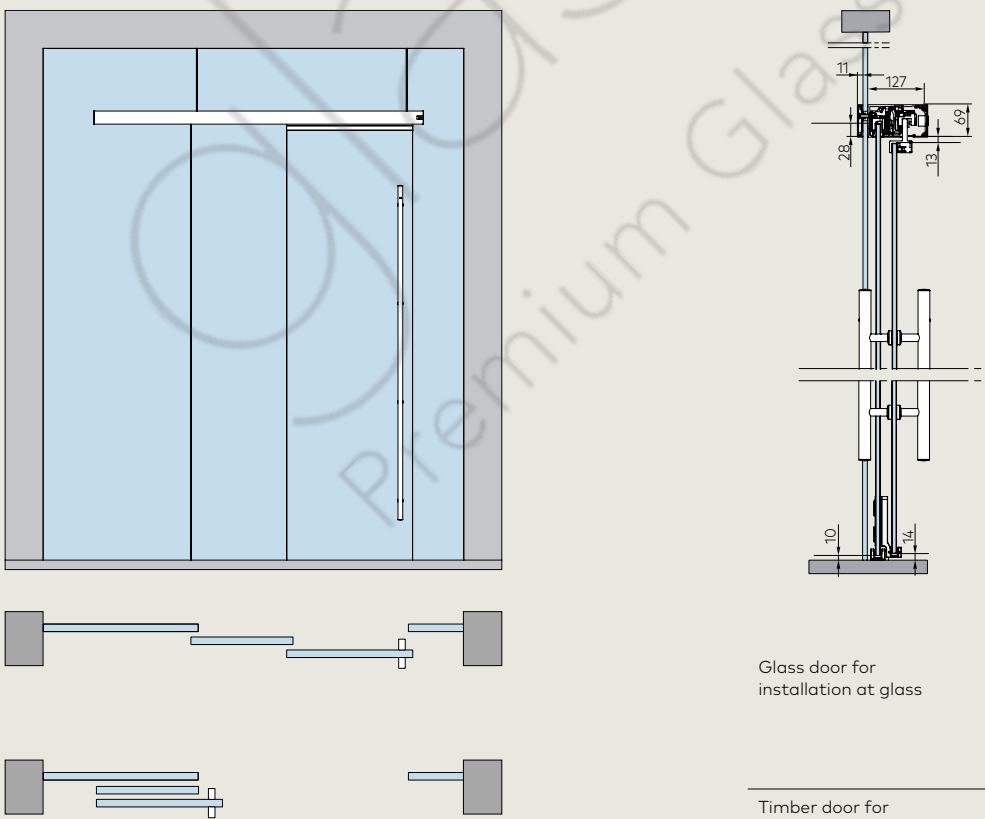



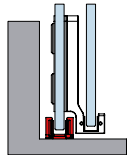

	Set No.	Page
Glass door for installation at glass	10 / 11 / 12	121
	22 / 23 / 24	125
Timber door for installation at glass	34 / 35 / 36	129

Glass door (8 - 13,5 mm) for installation at wall, 2 and 4 panels

Sliding

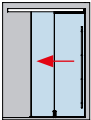

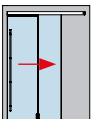
AL silver anod (150)	AL niro anod (157)	AL white p-coat (350)	AL special color anod (199)	AL special color p-coat (399)
-------------------------------	-----------------------------	--------------------------------	---	---

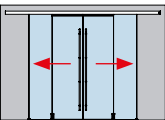
Art. No.	Description	€/Piece	€/Piece	€/Piece	€/Piece	€/Piece	
<b>MUTO Premium Telescopic 80</b>							
<b>Complete sets, prepared for option with DORMOTION</b>							
	<b>36.701 Set 1</b> For max. 1000 mm panel width (slow moving panel) for max. 3000 mm width of track rail** Consisting of: 1 profile set Telescopic 4 clamp carriers (for 8-13,5 mm glass thickness) with anti-jump device endstops incl. safety catch 1 Telescopic rope system <b>1 moving floor guide</b> <b>1 floor guide</b> 2 end caps incl. view protection brushes DIN Right Opening direction left, closing direction right	Basic*	1482,00	1573,00	1482,00	1831,00	1831,00
		Surcharge per mm	0,40	0,40	0,40	0,40	0,40
	<b>36.737 Set 1.1</b> do., for installation under lintel resp. with wall connection at 90° from closing direction	Basic*	1482,00	1573,00	1482,00	1831,00	1831,00
		Surcharge per mm	0,40	0,40	0,40	0,40	0,40
	<b>36.702 Set 2</b> For max. 1000 mm panel width (slow moving panel) for max. 3000 mm width of track rail** Consisting of: 1 profile set Telescopic 4 clamp carriers (for 8-13,5 mm glass thickness) with anti-jump device endstops incl. safety catch 1 Telescopic rope system <b>1 moving floor guide</b> <b>1 floor guide</b> 2 end caps incl. view protection brushes DIN Left Opening direction right, closing direction left	Basic*	1482,00	1573,00	1482,00	1831,00	1831,00
		Surcharge per mm	0,40	0,40	0,40	0,40	0,40
	<b>36.738 Set 2.1</b> do., for installation under lintel resp. with wall connection at 90° from closing direction	Basic*	1482,00	1573,00	1482,00	1831,00	1831,00
		Surcharge per mm	0,40	0,40	0,40	0,40	0,40
	<b>36.709 Set 3</b> Consisting of: 1 profile set Telescopic 8 clamp carriers (for 8-13,5 mm glass thickness) with anti-jump device endstops incl. safety catch 1 Telescopic rope system <b>2 moving floor guides</b> <b>2 floor guides</b> 2 end caps incl. view protection brushes	Basic*	2964,00	3146,00	2964,00	3662,00	3662,00

\* With assemblies in special color (399) the end caps will be delivered in plastic anthracite-grey solid-colored.

\*\* - In case of using a flush pull, all panels can reach 1000 mm. The track rail then will be 3000 mm.  
- For using a handle bar an indentation of approx. 120 mm is required.  
That means that the slow moving panel will have 976,7 mm, but track rail will remain at 3000 mm.  
- If length of track rail will exceed 3000 mm a surcharge will be applied.

### Glass door (8 - 13,5 mm) for installation at ceiling/with sidelight, 2 and 4 panels

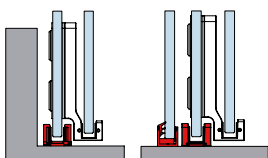

AL silver anod (150)	AL niro anod (157)	AL white p-coat (350)	AL special color anod (199)	AL special color p-coat (399)
----------------------	--------------------	-----------------------	-----------------------------	-------------------------------

Art. No.	Description	€/Piece	€/Piece	€/Piece	€/Piece	€/Piece
----------	-------------	---------	---------	---------	---------	---------

**MUTO Premium Telescopic 80**  
Complete sets, prepared for option with DORMOTION

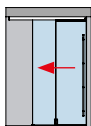

<b>36.703 Set 4</b>	For max. 1000 mm panel width (slow moving panel) for max. 3000 mm width of track rail** Consisting of: 1 profile set Telescopic 4 clamp carriers (for 8–13,5 mm glass thickness) with anti-jump device endstops incl. safety catch 1 Telescopic rope system <b>1 moving floor guide</b> <b>1 floor guide</b> 2 end caps incl. view protection brushes DIN Right Opening direction left, closing direction right	Basic*	1482,00	1573,00	1482,00	1831,00	1831,00
		Surcharge per mm	0,40	0,40	0,40	0,40	0,40

<b>36.739 Set 4.1</b>	do., for installation under lintel resp. with wall connection at 90° from closing direction	Basic*	1482,00	1573,00	1482,00	1831,00	1831,00
		Surcharge per mm	0,40	0,40	0,40	0,40	0,40

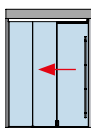

<b>36.704 Set 5</b>	For max. 1000 mm panel width (slow moving panel) for max. 3000 mm width of track rail** incl. sidelight Consisting of: 1 profile set Telescopic 4 clamp carriers (for 8–13,5 mm glass thickness) with anti-jump device endstops incl. safety catch 1 Telescopic rope system <b>1 moving floor guide</b> <b>1 floor guide</b> 2 end caps incl. view protection brushes DIN Right Opening direction left, closing direction right	Basic*	1703,00	1820,00	1703,00	2145,00	2145,00
		Surcharge per mm	0,40	0,40	0,40	0,40	0,40

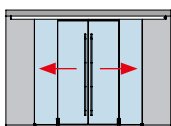

<b>36.710 Set 6</b>	Consisting of: 1 profile set Telescopic 8 clamp carriers (for 8–13,5 mm glass thickness) with anti-jump device endstops incl. safety catch 1 Telescopic rope system <b>2 moving floor guides</b> <b>2 floor guides</b> 2 end caps incl. view protection brushes	Basic*	2964,00	3146,00	2964,00	3662,00	3662,00
		Surcharge per mm	0,40	0,40	0,40	0,40	0,40

**Single components (optional)**

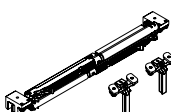

<b>36.786</b>	MUTO Premium Telescopic 80 DORMOTION unit incl. starter	(000) 199,00
---------------	---	-----------------

\* With assemblies in special color (399) the end caps will be delivered in plastic anthracite-grey solid-colored.

\*\* - In case of using a flush pull, all panels can reach 1000 mm. The track rail then will be 3000 mm.  
- For using a handle bar an indentation of approx. 120 mm is required.  
That means that the slow moving panel will have 976,7 mm, but track rail will remain at 3000 mm.  
- If length of track rail will exceed 3000 mm a surcharge will be applied.

LSG accessories, Status-indicator and integrated locking mechanism on pages 130–131.

Glass door (8 - 13,5 mm) for installation at ceiling/with sidelight, 2 and 4 panels

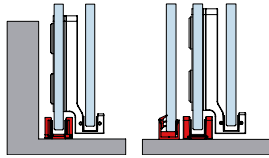

AL silver anod (150)	AL niro anod (157)	AL white p-coat (350)	AL special color anod (199)	AL special color p-coat (399)
----------------------	--------------------	-----------------------	-----------------------------	-------------------------------

\*

Art. No. Description €/Piece €/Piece €/Piece €/Piece €/Piece

**MUTO Premium Telescopic 80**  
Complete sets, prepared for option with DORMOTION

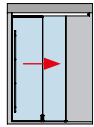

<b>36.705</b>	<b>Set 7</b> For max. 1000 mm panel width (slow moving panel) for max. 3000 mm width of track rail** Consisting of: 1 profile set Telescopic 4 clamp carriers (for 8–13,5 mm glass thickness) with anti-jump device endstops incl. safety catch 1 Telescopic rope system <b>1 moving floor guide</b> <b>1 floor guide</b> 2 end caps incl. view protection brushes DIN Left Opening direction right, closing direction left	Basic*	1482,00	1573,00	1482,00	1831,00	1831,00
		Surcharge per mm	0,40	0,40	0,40	0,40	0,40

<b>36.740</b>	<b>Set 7.1</b> do., for installation under lintel resp. with wall connection at 90° from closing direction	Basic*	1482,00	1573,00	1482,00	1831,00	1831,00
		Surcharge per mm	0,40	0,40	0,40	0,40	0,40

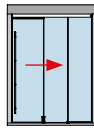

<b>36.706</b>	<b>Set 8</b> For max. 1000 mm panel width (slow moving panel) for max. 3000 mm width of track rail** incl. sidelight Consisting of: 1 profile set Telescopic 4 clamp carriers (for 8–13,5 mm glass thickness) with anti-jump device endstops incl. safety catch 1 Telescopic rope system <b>1 moving floor guide</b> <b>1 floor guide</b> 2 end caps incl. view protection brushes DIN Left Opening direction right, closing direction left	Basic*	1703,00	1820,00	1703,00	2145,00	2145,00
		Surcharge per mm	0,40	0,40	0,40	0,40	0,40

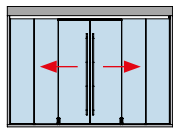

<b>36.711</b>	<b>Set 9</b> incl. sidelight Consisting of: 1 profile set Telescopic 8 clamp carriers (for 8–13,5 mm glass thickness) with anti-jump device endstops incl. safety catch 1 Telescopic rope system <b>2 moving floor guides</b> <b>2 floor guides</b> 2 end caps incl. view protection brushes	3407,00	3641,00	3407,00	4290,00	4290,00
---------------	--	---------	---------	---------	---------	---------

\* With assemblies in special color (399) the end caps will be delivered in plastic anthracite-grey solid-colored.

\*\* - In case of using a flush pull, all panels can reach 1000 mm. The track rail then will be 3000 mm.  
- For using a handle bar an indentation of approx. 120 mm is required.  
That means that the slow moving panel will have 976,7 mm, but track rail will remain at 3000 mm.  
- If length of track rail will exceed 3000 mm a surcharge will be applied.



### Glass door (8 - 13,5 mm) with glass overpanel and glass sidelights, 2 and 4 panels

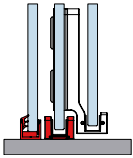

AL silver anod (150)	AL niro anod (157)	AL white p-coat (350)	AL special color anod (199)	AL special color p-coat (399)
----------------------	--------------------	-----------------------	-----------------------------	-------------------------------

\*

Art. No.	Description	€/Piece	€/Piece	€/Piece	€/Piece	€/Piece
----------	-------------	---------	---------	---------	---------	---------

**MUTO Premium Telescopic 80**  
Complete sets, prepared for option with DORMOTION

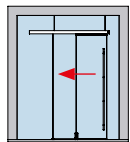

**36.707 Set 10**  
For max. 1000 mm panel width (slow moving panel)  
for max. 3000 mm width of track rail\*\*  
incl. sidelight  
Consisting of:  
1 profile set Telescopic  
4 clamp carriers (for 8-13,5 mm glass thickness)  
with anti-jump device  
endstops incl. safety catch  
1 Telescopic rope system  
**1 moving floor guide**  
**1 floor guide**  
2 end caps incl. view protection brushes  
DIN Right  
Opening direction left, closing direction right

Basic*	1719,00	1831,00	1719,00	2138,00	2138,00
Surcharge per mm	0,40	0,40	0,40	0,40	0,40

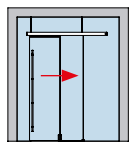

**36.708 Set 11**  
For max. 1000 mm panel width (slow moving panel)  
for max. 3000 mm width of track rail\*\*  
incl. sidelight  
Consisting of:  
1 profile set Telescopic  
4 clamp carriers (for 8-13,5 mm glass thickness)  
with anti-jump device  
endstops incl. safety catch  
1 Telescopic rope system  
**1 moving floor guide**  
**1 floor guide**  
2 end caps incl. view protection brushes  
DIN Left  
Opening direction right, closing direction left

Basic*	1719,00	1831,00	1719,00	2138,00	2138,00
Surcharge per mm	0,40	0,40	0,40	0,40	0,40

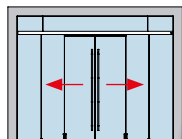

**36.712 Set 12**  
incl. sidelight  
Consisting of:  
1 profile set Telescopic  
8 clamp carriers (for 8-13,5 mm glass thickness)  
with anti-jump device  
endstops incl. safety catch  
1 Telescopic rope system  
**2 moving floor guides**  
**2 floor guides**  
2 end caps incl. view protection brushes

3428,00	3662,00	3428,00	4277,00	4277,00
---------	---------	---------	---------	---------

**Single components (optional)**

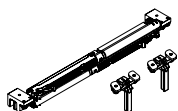

**36.786** MUTO Premium Telescopic 80 DORMOTION unit  
incl. starter

(000)
199,00

\* With assemblies in special color (399) the end caps will be delivered in plastic anthracite-grey solid-colored.

\*\* - In case of using a flush pull, all panels can reach 1000 mm. The track rail then will be 3000 mm.  
- For using a handle bar an indentation of approx. 120 mm is required.  
That means that the slow moving panel will have 976,7 mm, but track rail will remain at 3000 mm.  
- If length of track rail will exceed 3000 mm a surcharge will be applied.

LSG accessories, Status-indicator and integrated locking mechanism on pages 130-131.

**Glass door (8 - 13,5 mm) for installation at wall, 2 and 4 panels**

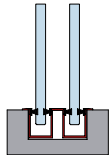

AL silver anod (150)	AL niro anod (157)	AL white p-coat (350)	AL special color anod (199)	AL special color p-coat (399)
-------------------------------	-----------------------------	--------------------------------	---	---

\*

Art. No. Description €/Piece €/Piece €/Piece €/Piece €/Piece

**MUTO Premium Telescopic 80  
Complete sets, prepared for option with DORMOTION**

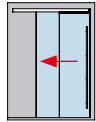

<b>36.713</b>	<b>Set 13</b> For max. 1000 mm panel width (slow moving panel) for max. 3000 mm width of track rail** Consisting of: 1 profile set Telescopic 4 clamp carriers (for 8–13,5 mm glass thickness) with anti-jump device endstops incl. safety catch 1 Telescopic rope system <b>recessed floor guide set</b> 2 end caps incl. view protection brushes DIN Right Opening direction left, closing direction right	Basic*	1482,00	1573,00	1482,00	1831,00	1831,00
		Surcharge per mm	0,40	0,40	0,40	0,40	0,40

<b>36.741</b>	<b>Set 13.1</b> do., for installation under lintel resp. with wall connection at 90° from closing direction	Basic*	1482,00	1573,00	1482,00	1831,00	1831,00
		Surcharge per mm	0,40	0,40	0,40	0,40	0,40

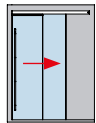

<b>36.714</b>	<b>Set 14</b> For max. 1000 mm panel width (slow moving panel) for max. 3000 mm width of track rail** Consisting of: 1 profile set Telescopic 4 clamp carriers (for 8–13,5 mm glass thickness) with anti-jump device endstops incl. safety catch 1 Telescopic rope system <b>recessed floor guide set</b> 2 end caps incl. view protection brushes DIN Left Opening direction right, closing direction left	Basic*	1482,00	1573,00	1482,00	1831,00	1831,00
		Surcharge per mm	0,40	0,40	0,40	0,40	0,40

<b>36.742</b>	<b>Set 14.1</b> do., for installation under lintel resp. with wall connection at 90° from closing direction	Basic*	1482,00	1573,00	1482,00	1831,00	1831,00
		Surcharge per mm	0,40	0,40	0,40	0,40	0,40

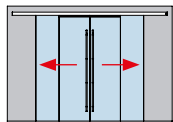

<b>36.721</b>	<b>Set 15</b> Consisting of: 1 profile set Telescopic 8 clamp carriers (for 8–13,5 mm glass thickness) with anti-jump device endstops incl. safety catch 1 Telescopic rope system <b>recessed floor guide set</b> 2 end caps incl. view protection brushes	Basic*	2964,00	3146,00	2964,00	3662,00	3662,00
		Surcharge per mm	0,40	0,40	0,40	0,40	0,40

\* With assemblies in special color (399) the end caps will be delivered in plastic anthracite-grey solid-colored.

\*\* - In case of using a flush pull, all panels can reach 1000 mm. The track rail then will be 3000 mm.  
- For using a handle bar an indentation of approx. 120 mm is required.  
That means that the slow moving panel will have 976,7 mm, but track rail will remain at 3000 mm.  
- If length of track rail will exceed 3000 mm a surcharge will be applied.

**Glass door (8 - 13,5 mm) for installation at ceiling/with sidelight, 2 and 4 panels**

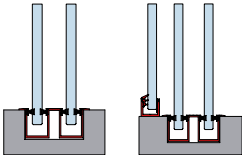

AL silver anod (150)	AL niro anod (157)	AL white p-coat (350)	AL special color anod (199)	AL special color p-coat (399)
				*

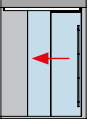
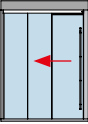
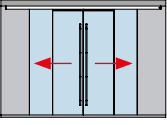
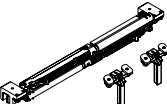
Art. No.	Description	€/Piece	€/Piece	€/Piece	€/Piece	€/Piece	
<b>MUTO Premium Telescopic 80</b>							
<b>Complete sets, prepared for option with DORMOTION</b>							
	<b>36.715 Set 16</b> For max. 1000 mm panel width (slow moving panel) for max. 3000 mm width of track rail** Consisting of: 1 profile set Telescopic 4 clamp carriers (for 8-13,5 mm glass thickness) with anti-jump device endstops incl. safety catch 1 Telescopic rope system <b>recessed floor guide set</b> 2 end caps incl. view protection brushes DIN Right Opening direction left, closing direction right	Basic* Surcharge per mm	1482,00 0,40	1573,00 0,40	1482,00 0,40	1831,00 0,40	1831,00 0,40
	<b>36.743 Set 16.1</b> do., for installation under lintel resp. with wall connection at 90° from closing direction	Basic* Surcharge per mm	1482,00 0,40	1573,00 0,40	1482,00 0,40	1831,00 0,40	1831,00 0,40
	<b>36.716 Set 17</b> For max. 1000 mm panel width (slow moving panel) for max. 3000 mm width of track rail** incl. sidelight Consisting of: 1 profile set Telescopic 4 clamp carriers (for 8-13,5 mm glass thickness) with anti-jump device endstops incl. safety catch 1 Telescopic rope system <b>recessed floor guide set</b> 2 end caps incl. view protection brushes DIN Right Opening direction left, closing direction right	Basic* Surcharge per mm	1703,00 0,40	1820,00 0,40	1703,00 0,40	2145,00 0,40	2145,00 0,40
	<b>36.722 Set 18</b> Consisting of: 1 profile set Telescopic 8 clamp carriers (for 8-13,5 mm glass thickness) with anti-jump device endstops incl. safety catch 1 Telescopic rope system <b>recessed floor guide set</b> 2 end caps incl. view protection brushes		2964,00	3146,00	2964,00	3662,00	3662,00
	<b>36.786</b> MUTO Premium Telescopic 80 DORMOTION unit incl. starter	(000) 199,00					

\* With assemblies in special color (399) the end caps will be delivered in plastic anthracite-grey solid-colored.

\*\* - In case of using a flush pull, all panels can reach 1000 mm. The track rail then will be 3000 mm.  
 - For using a handle bar an indentation of approx. 120 mm is required.  
 That means that the slow moving panel will have 976,7 mm, but track rail will remain at 3000 mm.  
 - If length of track rail will exceed 3000 mm a surcharge will be applied.

LSG accessories, Status-indicator and integrated locking mechanism on pages 130-131.

Glass door (8 - 13,5 mm) for installation at ceiling/with sidelight, 2 and 4 panels

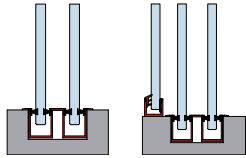

AL silver anod (150)	AL niro anod (157)	AL white p-coat (350)	AL special color anod (199)	AL special color p-coat (399)
----------------------	--------------------	-----------------------	-----------------------------	-------------------------------

\*

Art. No.	Description	€/Piece	€/Piece	€/Piece	€/Piece	€/Piece
----------	-------------	---------	---------	---------	---------	---------

**MUTO Premium Telescopic 80**  
Complete sets, prepared for option with DORMOTION

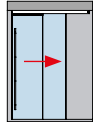

<b>36.717</b>	<b>Set 19</b> For max. 1000 mm panel width (slow moving panel) for max. 3000 mm width of track rail** Consisting of: 1 profile set Telescopic 4 clamp carriers (for 8–13,5 mm glass thickness) with anti-jump device endstops incl. safety catch 1 Telescopic rope system <b>recessed floor guide set</b> 2 end caps incl. view protection brushes DIN Left Opening direction right, closing direction left	Basic*	1482,00	1573,00	1482,00	1831,00	1831,00
		Surcharge per mm	0,40	0,40	0,40	0,40	0,40

<b>36.744</b>	<b>Set 19.1</b> do., for installation under lintel resp. with wall connection at 90° from closing direction	Basic*	1482,00	1573,00	1482,00	1831,00	1831,00
		Surcharge per mm	0,40	0,40	0,40	0,40	0,40

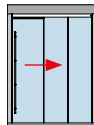

<b>36.718</b>	<b>Set 20</b> For max. 1000 mm panel width (slow moving panel) for max. 3000 mm width of track rail** incl. sidelight Consisting of: 1 profile set Telescopic 4 clamp carriers (for 8–13,5 mm glass thickness) with anti-jump device endstops incl. safety catch 1 Telescopic rope system <b>recessed floor guide set</b> 2 end caps incl. view protection brushes DIN Left Opening direction right, closing direction left	Basic*	1703,00	1820,00	1703,00	2145,00	2145,00
		Surcharge per mm	0,40	0,40	0,40	0,40	0,40

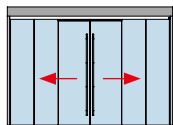

<b>36.723</b>	<b>Set 21</b> incl. sidelight Consisting of: 1 profile set Telescopic 8 clamp carriers (for 8–13,5 mm glass thickness) with anti-jump device endstops incl. safety catch 1 Telescopic rope system <b>recessed floor guide set</b> 2 end caps incl. view protection brushes	3407,00	3641,00	3407,00	4290,00	4290,00
---------------	---	---------	---------	---------	---------	---------

\* With assemblies in special color (399) the end caps will be delivered in plastic anthracite-grey solid-colored.

\*\* - In case of using a flush pull, all panels can reach 1000 mm. The track rail then will be 3000 mm.  
- For using a handle bar an indentation of approx. 120 mm is required.  
That means that the slow moving panel will have 976,7 mm, but track rail will remain at 3000 mm.  
- If length of track rail will exceed 3000 mm a surcharge will be applied.

**Glass door (8 - 13,5 mm) with glass overpanel and glass sidelights, 2 and 4 panels**

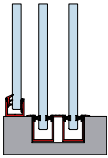

AL silver anod (150)	AL niro anod (157)	AL white p-coat (350)	AL special color anod (199)	AL special color p-coat (399)
				*

Art. No.	Description	€/Piece	€/Piece	€/Piece	€/Piece	€/Piece
----------	-------------	---------	---------	---------	---------	---------

**MUTO Premium Telescopic 80  
Complete sets, prepared for option with DORMOTION**

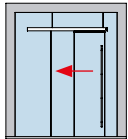

**36.719 Set 22**  
For max. 1000 mm panel width (slow moving panel)  
for max. 3000 mm width of track rail\*\*  
incl. sidelight  
Consisting of:  
1 profile set Telescopic  
4 clamp carriers (for 8-13,5 mm glass thickness)  
with anti-jump device  
endstops incl. safety catch  
1 Telescopic rope system  
**recessed floor guide set**  
2 end caps incl. view protection brushes  
DIN Right  
Opening direction left, closing direction right

Basic*	1719,00	1831,00	1719,00	2138,00	2138,00
Surcharge per mm	0,40	0,40	0,40	0,40	0,40

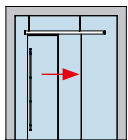

**36.720 Set 23**  
For max. 1000 mm panel width (slow moving panel)  
for max. 3000 mm width of track rail\*\*  
incl. sidelight  
Consisting of:  
1 profile set Telescopic  
4 clamp carriers (for 8-13,5 mm glass thickness)  
with anti-jump device  
endstops incl. safety catch  
1 Telescopic rope system  
**recessed floor guide set**  
2 end caps  
incl. view protection brushes  
DIN Left  
Opening direction right, closing direction left

Basic*	1719,00	1831,00	1719,00	2138,00	2138,00
Surcharge per mm	0,40	0,40	0,40	0,40	0,40

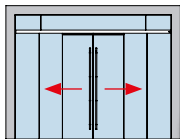

**36.724 Set 24**  
incl. sidelight  
Consisting of:  
1 profile set Telescopic  
8 clamp carriers (for 8-13,5 mm glass thickness)  
with anti-jump device  
endstops incl. safety catch  
1 Telescopic rope system  
**recessed floor guide set**  
2 end caps incl. view protection brushes

3439,00	3662,00	3439,00	4277,00	4277,00
---------	---------	---------	---------	---------

**Single components (optional)**

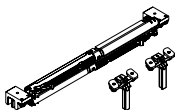

**36.786** MUTO Premium Telescopic 80 DORMOTION unit  
incl. starter

(000)
199,00

\* With assemblies in special color (399) the end caps will be delivered in plastic anthracite-grey solid-colored.

\*\* - In case of using a flush pull, all panels can reach 1000 mm. The track rail then will be 3000 mm.  
- For using a handle bar an indentation of approx. 120 mm is required.  
That means that the slow moving panel will have 976,7 mm, but track rail will remain at 3000 mm.  
- If length of track rail will exceed 3000 mm a surcharge will be applied.

LSG accessories, Status-indicator and integrated locking mechanism on pages 130-131.

Timber door (28 - 50 mm) for installation at wall, 2 and 4 panels

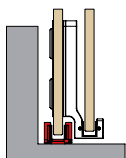

AL silver anod (150)	AL niro anod (157)	AL white p-coat (350)	AL special color anod (199)	AL special color p-coat (399)
----------------------	--------------------	-----------------------	-----------------------------	-------------------------------

\*

Art. No. Description €/Piece €/Piece €/Piece €/Piece €/Piece

MUTO Premium Telescopic 80 Complete sets, prepared for option with DORMOTION

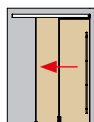

36.725	<b>Set 25</b> For max. 1000 mm panel width (slow moving panel) for max. 3000 mm width of track rail** Consisting of: 1 profile set Telescopic 4 clamp carriers with anti-jump device endstops incl. safety catch 1 Telescopic rope system <b>1 moving floor guide</b> <b>1 floor guide</b> 2 end caps incl. view protection brushes DIN Right Opening direction left, closing direction right	Basic*	1482,00	1573,00	1482,00	1831,00	1831,00
		Surcharge per mm	0,40	0,40	0,40	0,40	0,40

36.792	<b>Set 25.1</b> do., for installation under lintel resp. with wall connection at 90° from closing direction	Basic*	1482,00	1573,00	1482,00	1831,00	1831,00
		Surcharge per mm	0,40	0,40	0,40	0,40	0,40

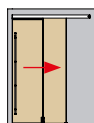

36.726	<b>Set 26</b> For max. 1000 mm panel width (slow moving panel) for max. 3000 mm width of track rail** Consisting of: 1 profile set Telescopic 4 clamp carriers with anti-jump device endstops incl. safety catch 1 Telescopic rope system 1 moving floor guide <b>1 floor guide</b> <b>2 end caps</b> incl. view protection brushes DIN Left Opening direction right, closing direction left	Basic*	1482,00	1573,00	1482,00	1831,00	1831,00
		Surcharge per mm	0,40	0,40	0,40	0,40	0,40

36.793	<b>Set 26.1</b> do., for installation under lintel resp. with wall connection at 90° from closing direction	Basic*	1482,00	1573,00	1482,00	1831,00	1831,00
		Surcharge per mm	0,40	0,40	0,40	0,40	0,40

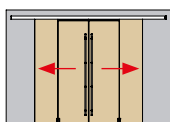

36.733	<b>Set 27</b> Consisting of: 1 profile set Telescopic 8 clamp carriers with anti-jump device endstops incl. safety catch 1 Telescopic rope system <b>2 moving floor guides</b> <b>2 floor guides</b> 2 end caps incl. view protection brushes	Basic*	2964,00	3146,00	2964,00	3662,00	3662,00
		Surcharge per mm	0,40	0,40	0,40	0,40	0,40

\* With assemblies in special color (399) the end caps will be delivered in plastic anthracite-grey solid-colored.

\*\* - In case of using a flush pull, all panels can reach 1000 mm. The track rail then will be 3000 mm.  
- For using a handle bar an indentation of approx. 120 mm is required.  
That means that the slow moving panel will have 976,7 mm, but track rail will remain at 3000 mm.  
- If length of track rail will exceed 3000 mm a surcharge will be applied.

**Timber door ( 28 - 50 mm) for installation at ceiling/with sidelight, 2 and 4 panels**

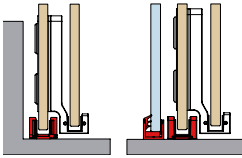

AL silver anod (150)	AL niro anod (157)	AL white p-coat (350)	AL special color anod (199)	AL special color p-coat (399)
----------------------	--------------------	-----------------------	-----------------------------	-------------------------------

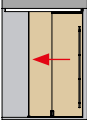
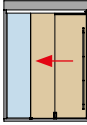
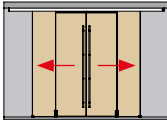
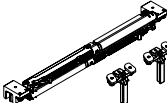
Art. No.	Description	€/Piece	€/Piece	€/Piece	€/Piece	€/Piece	
<b>MUTO Premium Telescopic 80</b>							
<b>Complete sets, prepared for option with DORMOTION</b>							
	<b>36.727 Set 28</b> For max. 1000 mm panel width (slow moving panel) for max. 3000 mm width of track rail** Consisting of: 1 profile set Telescopic 4 clamp carriers with anti-jump device endstops incl. safety catch 1 Telescopic rope system <b>1 moving floor guide</b> <b>1 floor guide</b> 2 end caps incl. view protection brushes DIN Right Opening direction left, closing direction right	Basic* Surcharge per mm	1482,00 0,40	1573,00 0,40	1482,00 0,40	1831,00 0,40	1831,00 0,40
	<b>36.794 Set 28.1</b> do., for installation under lintel resp. with wall connection at 90° from closing direction	Basic* Surcharge per mm	1482,00 0,40	1573,00 0,40	1482,00 0,40	1831,00 0,40	1831,00 0,40
	<b>36.728 Set 29</b> For max. 1000 mm panel width (slow moving panel) for max. 3000 mm width of track rail** incl. sidelight Consisting of: 1 profile set Telescopic 4 clamp carriers with anti-jump device endstops incl. safety catch 1 Telescopic rope system <b>1 moving floor guide</b> <b>1 floor guide</b> 2 end caps incl. view protection brushes DIN Right Opening direction left, closing direction right	Basic* Surcharge per mm	1703,00 0,40	1820,00 0,40	1703,00 0,40	2145,00 0,40	2145,00 0,40
	<b>36.734 Set 30</b> Consisting of: 1 profile set Telescopic 8 clamp carriers with anti-jump device endstops incl. safety catch 1 Telescopic rope system <b>2 moving floor guides</b> <b>2 floor guides</b> 2 end caps incl. view protection brushes		2964,00	3146,00	2964,00	3662,00	3662,00
	<b>36.786</b> MUTO Premium Telescopic 80 DORMOTION unit incl. starter	(000) 199,00					

\* With assemblies in special color (399) the end caps will be delivered in plastic anthracite-grey solid-colored.

\*\* - In case of using a flush pull, all panels can reach 1000 mm. The track rail then will be 3000 mm.  
- For using a handle bar an indentation of approx. 120 mm is required.  
That means that the slow moving panel will have 976,7 mm, but track rail will remain at 3000 mm.  
- If length of track rail will exceed 3000 mm a surcharge will be applied.

LSG accessories, Status-indicator and integrated locking mechanism on pages 130-131.

Timber door ( 28 - 50 mm) for installation at ceiling/with sidelight, 2 and 4 panels

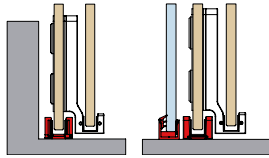

AL silver anod (150)	AL niro anod (157)	AL white p-coat (350)	AL special color anod (199)	AL special color p-coat (399)
----------------------	--------------------	-----------------------	-----------------------------	-------------------------------

\*

Art. No.	Description	€/Piece	€/Piece	€/Piece	€/Piece	€/Piece	
<b>MUTO Premium Telescopic 80</b>							
<b>Complete sets, prepared for option with DORMOTION</b>							
	<b>36.729 Set 31</b> For max. 1000 mm panel width (slow moving panel) for max. 3000 mm width of track rail** Consisting of: 1 profile set Telescopic 4 clamp carriers with anti-jump device endstops incl. safety catch 1 Telescopic rope system <b>1 moving floor guide</b> <b>1 floor guide</b> 2 end caps incl. view protection brushes DIN Left Opening direction right, closing direction left	Basic*	1482,00	1573,00	1482,00	1831,00	1831,00
		Surcharge per mm	0,40	0,40	0,40	0,40	0,40
	<b>36.795 Set 31.1</b> do., for installation under lintel resp. with wall connection at 90° from closing direction	Basic*	1482,00	1573,00	1482,00	1831,00	1831,00
		Surcharge per mm	0,40	0,40	0,40	0,40	0,40
	<b>36.730 Set 32</b> For max. 1000 mm panel width (slow moving panel) for max. 3000 mm width of track rail** incl. sidelight Consisting of: 1 profile set Telescopic 4 clamp carriers with anti-jump device endstops incl. safety catch 1 Telescopic rope system <b>1 moving floor guide</b> <b>1 floor guide</b> 2 end caps incl. view protection brushes DIN Left Opening direction right, closing direction left	Basic*	1703,00	1820,00	1703,00	2145,00	2145,00
		Surcharge per mm	0,40	0,40	0,40	0,40	0,40
	<b>36.735 Set 33</b> incl. sidelight Consisting of: 1 profile set Telescopic 8 clamp carriers with anti-jump device endstops incl. safety catch 1 Telescopic rope system <b>2 moving floor guides</b> <b>2 floor guides</b> 2 end caps incl. view protection brushes	Basic*	3407,00	3641,00	3407,00	4290,00	4290,00

\* With assemblies in special color (399) the end caps will be delivered in plastic anthracite-grey solid-colored.

\*\* - In case of using a flush pull, all panels can reach 1000 mm. The track rail then will be 3000 mm.  
- For using a handle bar an indentation of approx. 120 mm is required.  
That means that the slow moving panel will have 976,7 mm, but track rail will remain at 3000 mm.  
- If length of track rail will exceed 3000 mm a surcharge will be applied.



**Timber door (28 - 50 mm) with glass overpanel and glass sidelights, 2 and 4 panels**

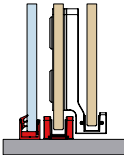

AL silver anod (150)	AL niro anod (157)	AL white p-coat (350)	AL special color anod (199)	AL special color p-coat (399)
				*

Art. No.	Description	€/Piece	€/Piece	€/Piece	€/Piece	€/Piece
----------	-------------	---------	---------	---------	---------	---------

**MUTO Premium Telescopic 80**  
Complete sets, prepared for option with DORMOTION

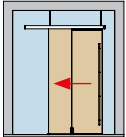

**36.731 Set 34**  
For max. 1000 mm panel width (slow moving panel)  
for max. 3000 mm width of track rail\*\*  
incl. sidelight  
Consisting of:  
1 profile set Telescopic  
4 clamp carriers with anti-jump device  
endstops incl. safety catch  
1 Telescopic rope system  
**1 moving floor guide**  
**1 floor guide**  
2 end caps incl. view protection brushes  
DIN Right  
Opening direction left, closing direction right

Basic*	1719,00	1831,00	1719,00	2138,00	2138,00
Surcharge per mm	0,40	0,40	0,40	0,40	0,40

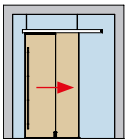

**36.732 Set 35**  
For max. 1000 mm panel width (slow moving panel)  
for max. 3000 mm width of track rail\*\*  
incl. sidelight  
Consisting of:  
1 profile set Telescopic  
4 clamp carriers with anti-jump device  
endstops incl. safety catch  
1 Telescopic rope system  
**1 moving floor guide**  
**1 floor guide**  
2 end caps incl. view protection brushes  
DIN Left  
Opening direction right, closing direction left

Basic*	1719,00	1831,00	1719,00	2138,00	2138,00
Surcharge per mm	0,40	0,40	0,40	0,40	0,40

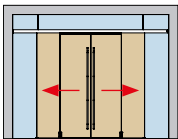

**36.736 Set 36**  
incl. sidelight  
Consisting of:  
1 profile set Telescopic  
8 clamp carriers with anti-jump device  
endstops incl. safety catch  
1 Telescopic rope system  
**2 moving floor guides**  
**2 floor guides**  
2 end caps incl. view protection brushes

3439,00	3662,00	3439,00	4277,00	4277,00
---------	---------	---------	---------	---------

**Single components (optional)**

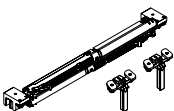

**36.786** MUTO Premium Telescopic 80 DORMOTION unit  
incl. starter

(000)
199,00

\* With assemblies in special color (399) the end caps will be delivered in plastic anthracite-grey solid-colored.



\*\* - In case of using a flush pull, all panels can reach 1000 mm. The track rail then will be 3000 mm.  
- For using a handle bar an indentation of approx. 120 mm is required.  
That means that the slow moving panel will have 976,7 mm, but track rail will remain at 3000 mm.  
- If length of track rail will exceed 3000 mm a surcharge will be applied.

LSG accessories, Status-indicator and integrated locking mechanism on pages 130-131.





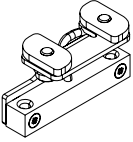
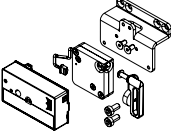
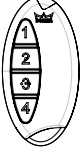
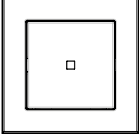
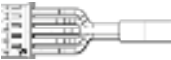



MUTO Comfort integrated locking mechanism/Status-indicator

Sliding

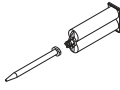
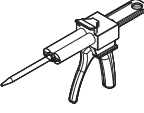
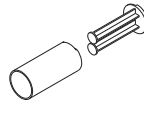
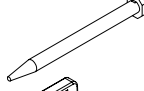
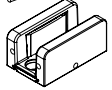
Base parts (000)	AL silver anod (150)	AL niro anod (157)	AL white p-coat (350)	AL special color anod (199)	AL special color p-coat (399)
------------------	----------------------	--------------------	-----------------------	-----------------------------	-------------------------------

Art. No.	Description	€/Piece	€/Piece	€/Piece	€/Piece	€/Piece	€/Piece
<b>Single components</b>							
	<b>36.840 MUTO Status-indicator-Set for Comfort L, Premium XL and Premium Self-Closing</b> consisting of: 1 Sensor 1 Receiver 1 Cable	332,00					
	<b>36.842 MUTO Integrated locking mechanism for Comfort L, Premium XL and Premium Self-Closing (no safety lock)</b> consisting of: 1 Receiver unit 1 Locking mechanism 1 Stopper L 1 Stopper XL 1 Battery	401,00					
<b>Please note: Not applicable for Synchro version.</b>							
	<b>36.845 Battery for MUTO Integrated locking mechanism</b>	15,00					
	<b>36.848 MUTO Remote control for Comfort L, Premium XL and Premium Self-Closing</b> 1 Remote control 1 Battery	101,00					
	<b>36.849 MUTO Wall switch with transmitter for Comfort L, Premium XL and Premium Self-Closing</b> 1 Wall switch 1 Battery	74,50					
	<b>36.855 MUTO Status-indicator (Cable-Set) for Comfort L, Premium XL and Premium Self-Closing</b> upgrade of the locking mechanism with a status-indicator	50,50					
	<b>29301003 Concealed transmitter BRC-T</b> DORMA bi-directional flush-mounted radio transmitter BRC-T, battery-operated, for installation in a switch with a deep flush-mounting box or a surface-mounted elbow switch/switch pad. Also suitable for heavy-duty applications In conjunction with DORMA stainless steel elbow switches; only suitable for use in conjunction with the DORMA radio receiver BRC-R, Art. No. 29302002 and additional radio push-button set 84020081	75,50					

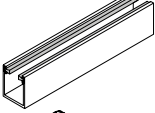
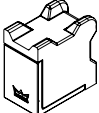
## MUTO Comfort Accessories

Art. No.	Description	Base parts (000)	AL silver anod (150)	AL niro anod (157)	AL white p-coat (350)	AL special color anod (199)	AL special color p-coat (399)
		€/Piece	€/Piece	€/Piece	€/Piece	€/Piece	€/Piece
<b>Single components</b>							
	<b>36.270 MUTO Comfort L 80 LSG-Set</b> Accessory set for use of laminated safety glass consisting of: 2 Gaskets 4 Injector screws	10,50					
	<b>36.468 MUTO Premium XL 80/150 LSG-Set</b> Accessory set for use of laminated safety glass consisting of: 2 Gaskets 4 Injector screws	11,00					
	<b>07.631 Special adhesive and mixing jet for use with LSG</b> (sufficient for ca. 10 clamp carriers)	84,00					
	<b>07.629 Automix-Squeezer</b> for use in combination with Art.-No. 07.631	111,00					
	<b>07.628 Automix-Adapter</b> for use in combination with Art. No. 07.631	9,00					
	<b>07.630 Automix-Adapter</b> for use in combination with Art.-No. 07.631	3,30					
	<b>36.105 MUTO Floor guide</b> infinitely adjustable for glass thicknesses up to 13,5 mm	23,50	26,00				
	<b>MUTO Telescopic moving floor guide</b>						
	<b>36.787</b> DIN Right, Opening direction left, closing direction right	110,00	118,00				
	<b>36.788</b> DIN Left, Opening direction right, closing direction left	110,00	118,00				
	<b>36.791 MUTO Telescopic moving floor guide for timber panels</b>	60,00	64,00				
	<b>MUTO Floor guide profile</b> with brushes						
	<b>36.561</b> stock length 6000 mm	211,00					
	<b>36.562</b> in fixed length	€/m	46,50				
	<b>36.851 MUTO Floor stopp</b> for Comfort M, L and Premium XL for glass- or timber panels	31,00	35,50				
	<b>36.890 MUTO Distance space set (2 pcs.)</b> For installation at ceiling between two walls	25,00					
	<b>Profile for false ceilings</b>						
	<b>36.821</b> stock length 6000 mm	120,00	137,00	120,00	164,00	164,00	
	<b>36.820</b> in fixed length	€/m	25,00	28,50	25,00	34,00	34,00

Sliding

MUTO Comfort Accessories

Sliding

Art. No.	Description	Base parts (000)	AL silver anod (150)	AL niro anod (157)	AL white p-coat (350)	AL special color anod (199)	AL special color p-coat (399)
		€/m	€/m	€/m	€/m	€/m	€/m
<b>MUTO carrier profile for vertical brush sealings</b>							
36.826	stock length: 4500 mm		12,50	13,00			
36.827	fix length up to 4500 mm		16,00	16,50			
<b>MUTO carrier profile with vertical brush sealing fix length up to 4500 mm</b>							
36.828	for gaps 13-16 mm		16,50	17,00			
36.829	for gaps 16-19 mm		17,00	17,50			
36.830	for gaps 19-23 mm		17,00	17,50			
36.831	for gaps 23-27 mm		17,50	18,00			
<b>MUTO vertical brush sealing fix length up to 4500 mm</b>							
36.860	for gaps 13-16 mm		0,60				
36.861	for gaps 16-19 mm		0,80				
36.862	for gaps 19-23 mm		0,80				
36.863	for gaps 23-27 mm		1,10				
<b>MUTO vertical brush sealing</b>							
36.864	for gaps 13-16 mm (300 m roll)	€/Stück	124,00				
36.865	for gaps 16-19 mm (250 m roll)		155,00				
36.866	for gaps 19-23 mm (250 m roll)		155,00				
36.867	for gaps 23-27 mm (150 m roll)		155,00				

# RS 120



Technical data	
Glass	TSG
glass thickness	8, 10, 12 mm
max. door panel weight	120 kg
Applications	1-/2 panels, side lights, Synchro version (Glass- and timber panels)
Material	Aluminium
Finishes	Eloxal and RAL colors
Kind of installation	Installation to wall/ceiling
Specials	Tested acc. DIN EN 1527 no glasspreparation Readjustable without dismantling +5/-5 mm

Example view for RS 120 installation at wall

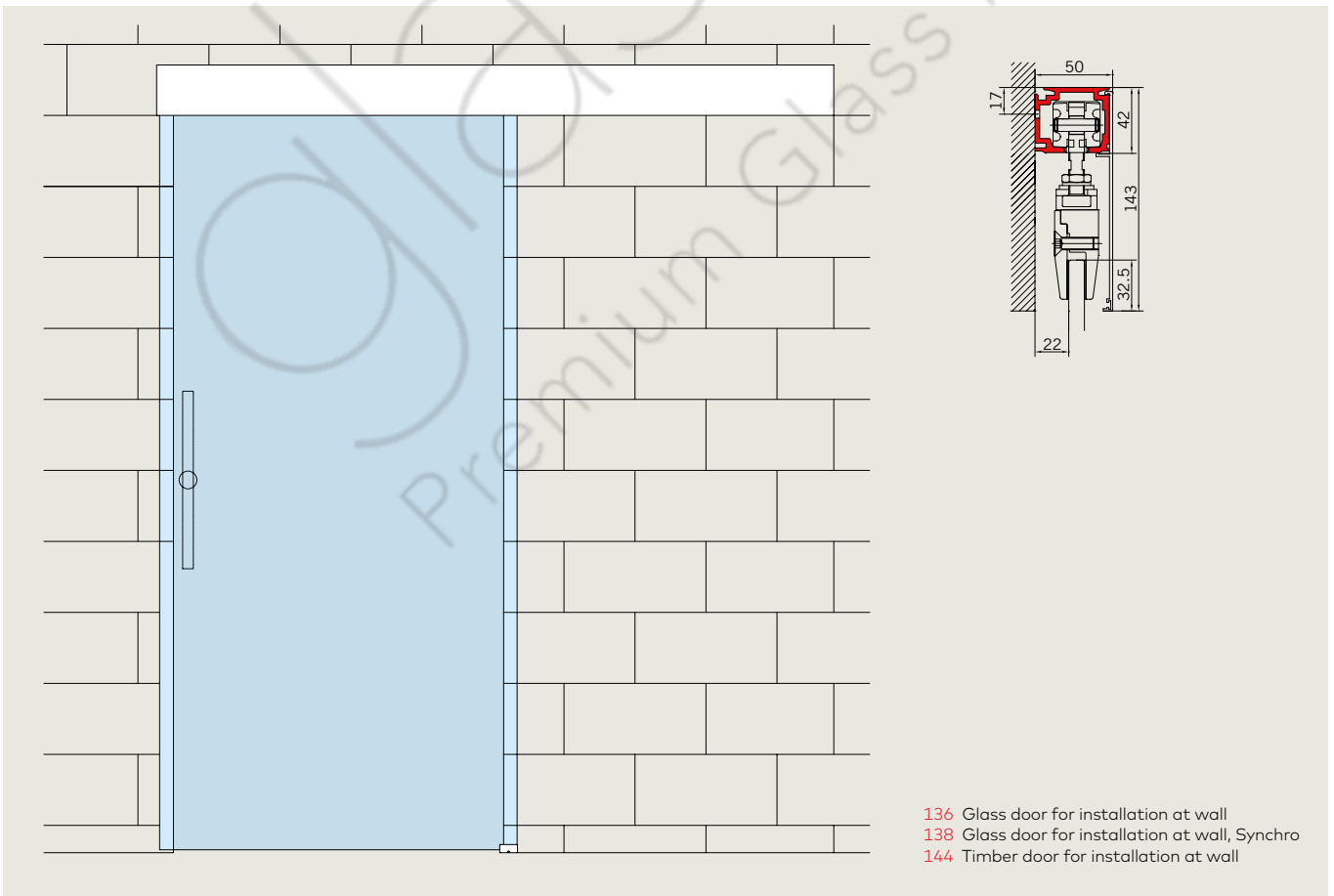

Example view for RS 120 installation at ceiling

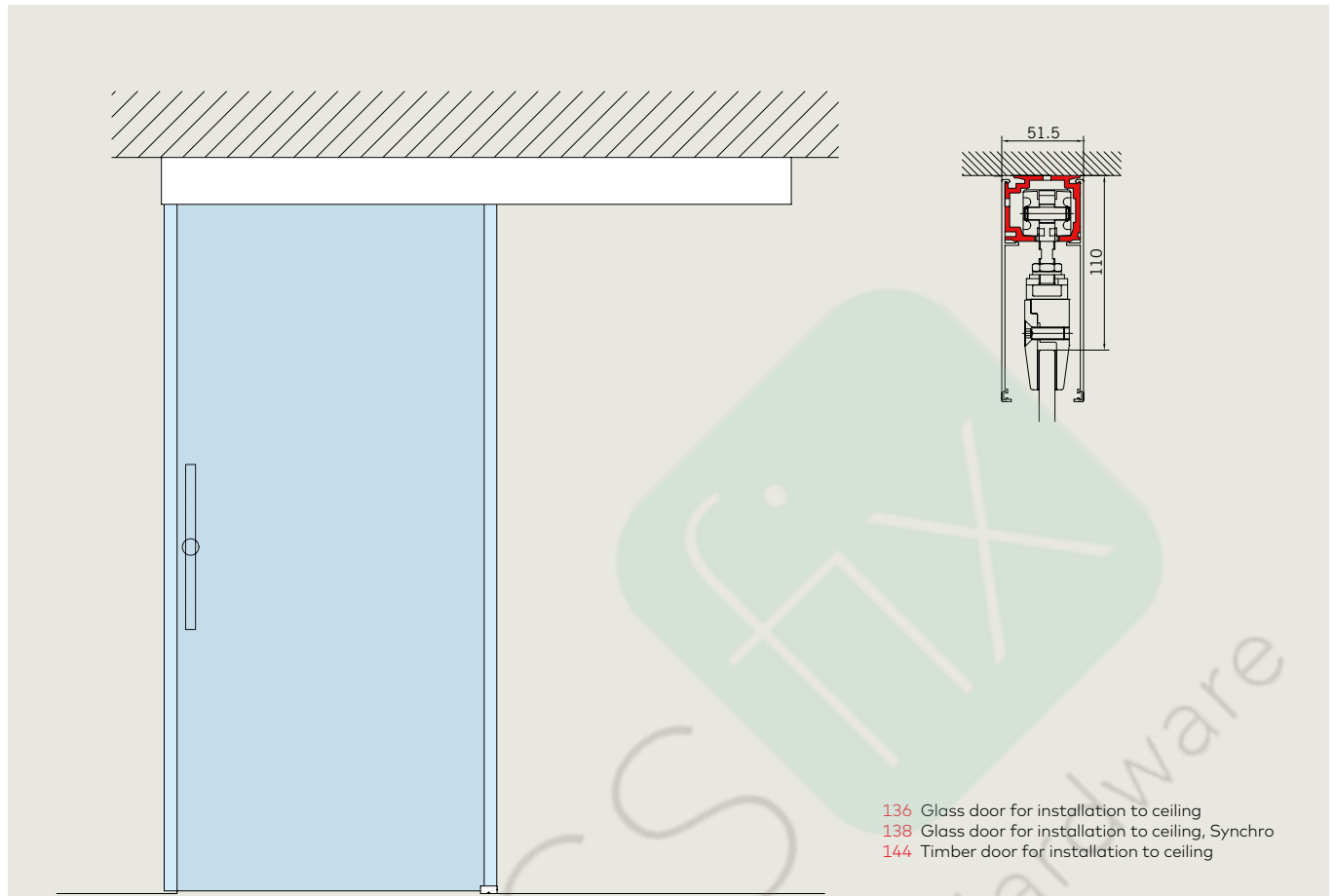

Sliding

Example view for RS 120 with glass sidelights

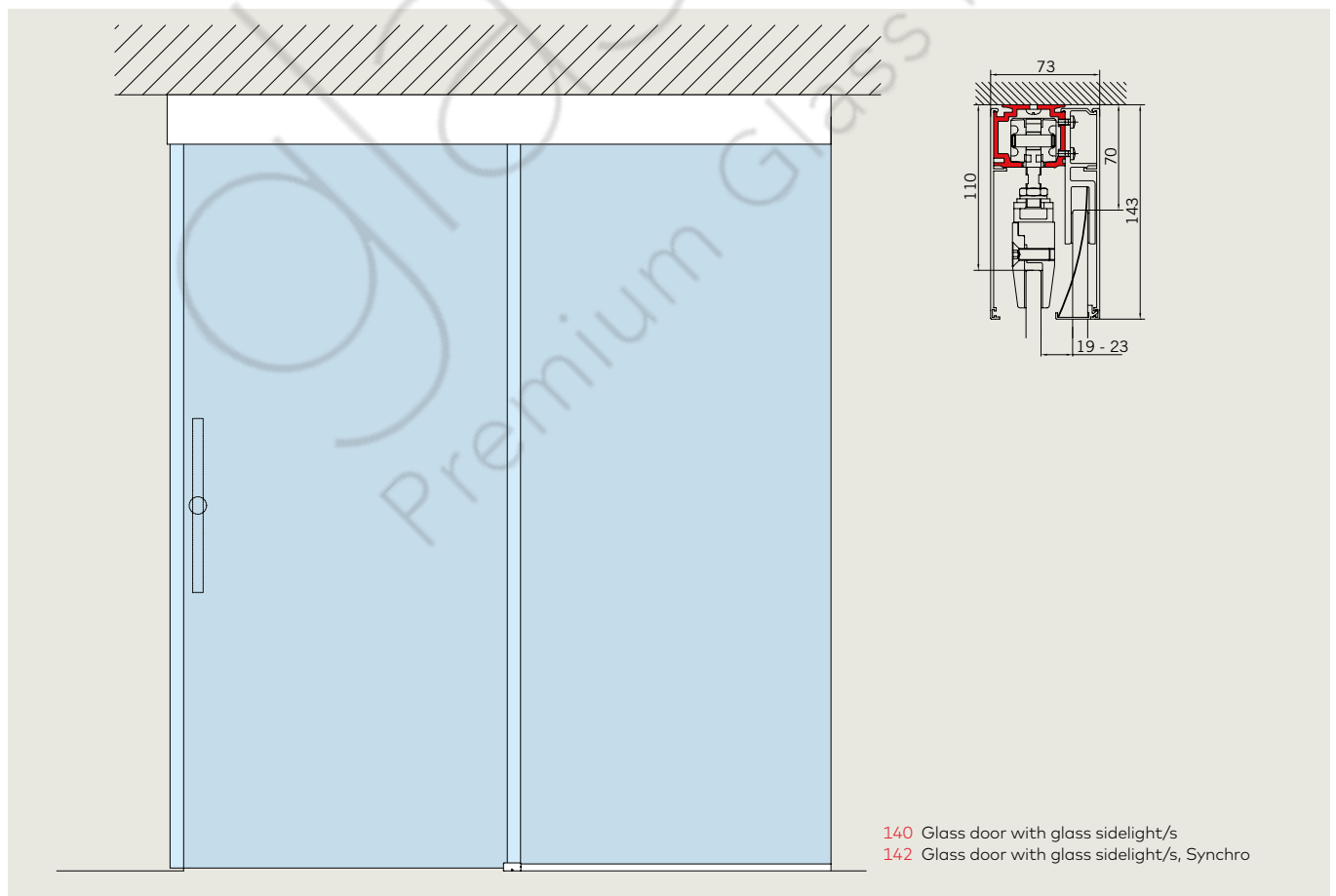

**Glass door (8 and 10 mm) for installation to wall / ceiling**

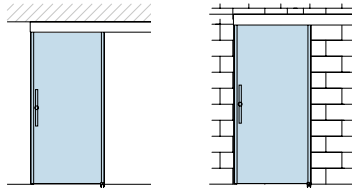

Base parts (000)	AL sim satin stainl steel anod C31 (113)	AL traffic white p-coat (300)	AL special color anod (199)	AL special color p-coat (399)
------------------	--	-------------------------------	-----------------------------	-------------------------------

Art. No.	Description	€/Piece	€/Piece	€/Piece	€/Piece	€/Piece
----------	-------------	---------	---------	---------	---------	---------

**Complete sets**

**Aluminium track profile = door width x 2  
max. panel weight = 120 kg,  
for 8 and 10 mm glass thickness**

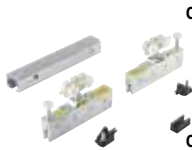

**07.101** Set, complete with accessories for 950 mm panel width

233,00



**07.102** Set, complete with accessories for 1450 mm panel width

266,00

**Set**

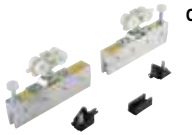

**07.125** **Accessory set complete,** consisting of:  
2 carriers with clamping patch (8 and 10 mm glass thickness) and support screw  
2 end stops  
1 floor guide

163,00

**Single components**



**07.118** **Pair of gaskets (aluminium)** for 12 mm glass thickness (for 2 clamping patches)

4,40









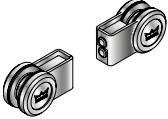

**07.123** **Additional carrier with clamping patch** for panel weight up to 150 kg

72,00

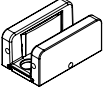

### Glass door (8 and 10 mm) for installation to wall / ceiling

Art. No.	Description	Base parts (000)	AL mill finish (100)	AL silver EV1 anod (101)	AL sim satin stain steel anod C31 (113)	AL traffic white p-coat (300)	AL special color anod (199)	AL special color p-coat (399)
		€/m	€/m	€/m	€/m	€/m	€/m	€/m
<b>Single components</b>								
	<b>07.121</b> Track with fixing holes 6000 mm stock length	34,00						
	<b>07.131</b> in fixed length	41,00						
	<b>Cover profile (clip-on)</b> with connecting web for view protection cover profile 07.137/138 6000 mm stock length							
	<b>07.140</b>		20,00	34,50	20,00	34,50	34,50	
	<b>07.141</b> in fixed length		25,00	43,00	25,00	43,00	43,00	
	<b>29.420</b> Door steady, to prevent glass edges of double sliding doors bumping into each other (glass preparation)	€/Pair 64,50						
	<b>07.127</b> Endcap for mounting on wall, including screws, LH/RH		€/Piece 17,00	€/Piece 25,00	€/Piece 17,00	€/Piece 25,00	€/Piece 25,00	€/Piece 25,00
	<b>07.129</b> Endcap for mounting on ceiling including screws, LH/RH		€/Piece 17,00	€/Piece 25,00	€/Piece 17,00	€/Piece 25,00	€/Piece 25,00	€/Piece 25,00
	<b>21.431</b> Guide rail with brush seal, fixed length up to 6.000 mm	49,00			61,00			
	<b>21.432</b> stock length 3.000 mm	€/Piece 117,00						
	<b>21.430</b> stock length 6.000 mm	€/Piece 219,00						
	<b>36.105</b> MUTO Floor guide infinitely adjustable for glass thicknesses up to 13,5 mm		€/Piece 23,50	(150)	€/Piece 26,00	(157)		
	<b>07.126</b> Floor guide	€/Piece 7,50						

Sliding

**Glass door (8 and 10 mm) for installation at wall and ceiling, Synchro**

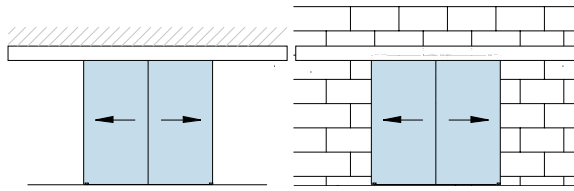

Base parts (000)	AL sim satin stainl steel anod C31 (113)	AL traffic white p-coat (300)	AL special color anod (199)	AL special color p-coat (399)
------------------	--	-------------------------------	-----------------------------	-------------------------------

Art. No.	Description	€/Piece	€/Piece	€/Piece	€/Piece	€/Piece
----------	-------------	---------	---------	---------	---------	---------

**Complete set**



**07.150 RS 120 Synchro Set**  
 For double leaf synchronously opening system,  
 max. panel width = 2 x 1000 mm,  
 max. weight = 80 kg per panel,  
 consisting of:  
 2 x accessory set 07.125  
 1 x deflexion accessory set incl. gear belt

**610,00**

**Track, sidelight profile, cover profile and view protection profile have to be ordered separately**

**Single components**



**07.118 Pair of gaskets (aluminium)**  
 for 12 mm glass thickness (for 2 clamping patches)

**4,40**







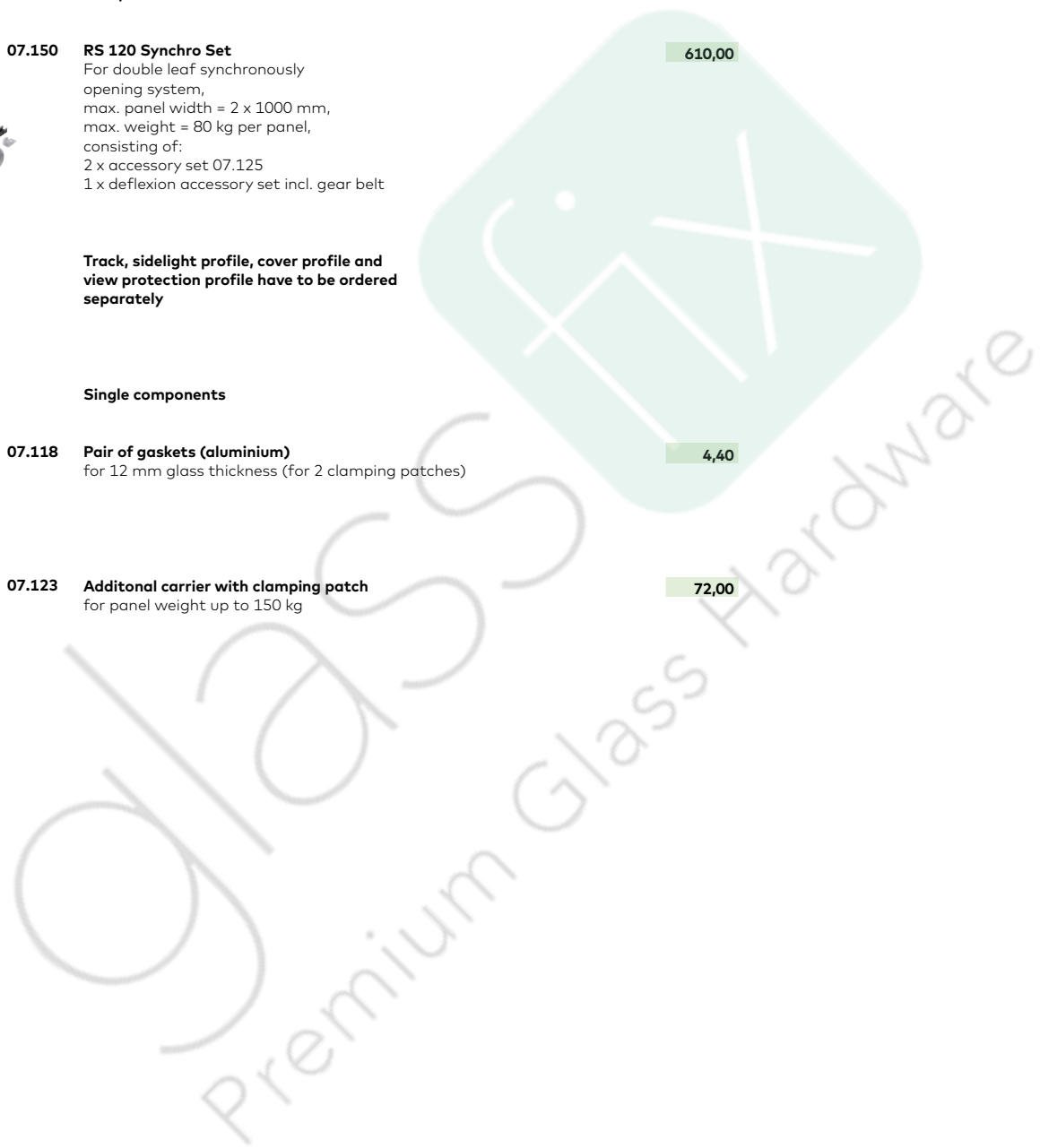

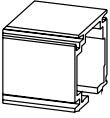

**07.123 Additional carrier with clamping patch**  
 for panel weight up to 150 kg

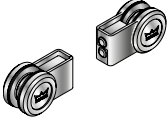
**72,00**

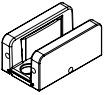

### Glass door (8 and 10 mm) for installation at wall and ceiling, Synchro





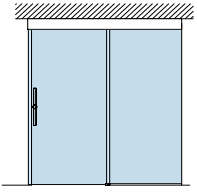

Art. No.	Description	Base parts (000)	AL mill finish (100)	AL silver EV1 anod (101)	AL sim satin stain steel anod C31 (113)	AL traffic white p-coat (300)	AL special color anod (199)	AL special color p-coat (399)
		€/m	€/m	€/m	€/m	€/m	€/m	€/m
<b>Single components</b>								
	<b>07.121</b> Track with fixing holes 6000 mm stock length	34,00						
	<b>07.131</b> in fixed length	41,00						
	<b>Cover profile (clip-on)</b> with connecting web for view protection cover profile 07.137/138 6000 mm stock length							
	<b>07.140</b>		20,00	34,50	20,00	34,50	34,50	
	<b>07.141</b> in fixed length		25,00	43,00	25,00	43,00	43,00	
	<b>29.420</b> Door steady, to prevent glass edges of double sliding doors bumping into each other (glass preparation)	€/Pair 64,50						
	<b>07.127</b> Endcap for mounting on wall, including screws, LH/RH		€/Piece 17,00	€/Piece 25,00	€/Piece 17,00	€/Piece 25,00	€/Piece 25,00	€/Piece 25,00
	<b>07.129</b> Endcap for mounting on ceiling including screws, LH/RH		€/Piece 17,00	€/Piece 25,00	€/Piece 17,00	€/Piece 25,00	€/Piece 25,00	€/Piece 25,00
	<b>21.431</b> Guide rail with brush seal, fixed length up to 6.000 mm	49,00			61,00			
	<b>21.432</b> stock length 3.000 mm	€/Piece 117,00						
	<b>21.430</b> stock length 6.000 mm	€/Piece 219,00						
	<b>36.105</b> MUTO Floor guide infinitely adjustable for glass thicknesses up to 13,5 mm		€/Piece 23,50	€/Piece 26,00	(150)	(157)		
	<b>07.126</b> Floor guide	€/Piece 7,50						

Glass door with sidelight/s (8 and 10 mm)









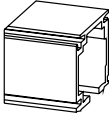

Base parts (000)	AL sim satin stainl steel anod C31 (113)	AL traffic white p-coat (300)	AL special color anod (199)	AL special color p-coat (399)
------------------	--	-------------------------------	-----------------------------	-------------------------------

Sliding

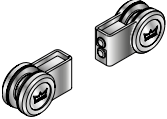
Art. No.	Description	€/Piece	€/Piece	€/Piece	€/Piece	€/Piece
<b>Complete sets</b>						
<b>Aluminium track = door width x 2</b> max. panel weight = 120 kg for 8 and 10 mm glass thickness						
 07.101	Set, complete with accessories, for 950 mm panel width	233,00				
 07.102	Set, complete with accessories, for 1450 mm panel width	266,00				
<b>Set</b>						
 07.125	<b>Accessory set complete,</b> consisting of: 2 carriers with clamping patch (8 and 10 mm glass thickness) and support screw 2 end stops 1 floor guide	163,00				
<b>Single components</b>						
 07.118	<b>Pair of gaskets (aluminium)</b> for 12 mm glass thickness (for 2 clamping patches)	4,40				
 07.123	<b>Additional carrier with clamping patch</b> for panel weight up to 150 kg	72,00				
 07.122	<b>Side panel profile without fixing holes,</b> for 8, 10 and 12 mm glass 6000 mm stock length	€/m 34,00				
07.132	in fixed length	€/m 41,00				

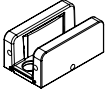
### Glass door with sidelight/s (8 and 10 mm)

Art. No.	Description	Base parts (000)	AL mill finish (100)	AL silver EV1 anod (101)	AL sim satin stain steel anod C31 (113)	AL traffic white p-coat (300)	AL special color anod (199)	AL special color p-coat (399)
€ /m	€ /m	€ /m	€ /m	€ /m	€ /m	€ /m	€ /m	
<b>Single components</b>								
	<b>07.121</b> Track with fixing holes 6000 mm stock length	34,00						
	<b>07.131</b> in fixed length	41,00						
	<b>Cover profile (clip-on)</b> with connecting web for view protection cover profile 07.137/138 6000 mm stock length			20,00	34,50	20,00	34,50	34,50
	<b>07.140</b> 6000 mm stock length			25,00	43,00	25,00	43,00	43,00
	<b>07.141</b> in fixed length							
	<b>07.138</b> Bottom view protection cover profile 6000 mm stock length, (only in combination with sidelight profile 07.132 / 122 and cover profile 07.141 / 140)			8,50			13,50	13,50
	<b>07.137</b> Bottom view protection cover profile, in fixed length, (only in combination with sidelight profile 07.132 / 122 and cover profile 07.141 / 140)			10,00		10,00	15,50	15,50
	<b>29.420</b> Door steady, to prevent glass edges of double sliding doors bumping into each other (glass preparation)	€/Pair 64,50						
	<b>21.431</b> Guide rail with brush seal, fixed length up to 6.000 mmm	49,00			61,00			
	<b>21.432</b> stock length 3.000 mm	€/Piece 117,00						
	<b>21.430</b> stock length 6.000 mm	€/Piece 219,00						
	<b>36.105</b> MUTO Floor guide infinitely adjustable for glass thicknesses up to 13,5 mm			(150) €/Piece 23,50	(157) €/Piece 26,00			
	<b>07.126</b> Floor guide	€/Piece 7,50						

Glass door with sidelight/s (8 and 10 mm), Synchro

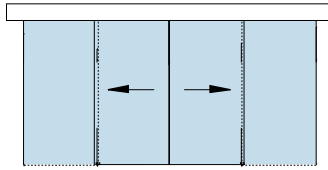

Base parts (000)	AL sim satin stainl steel anod C31 (113)	AL traffic white p-coat (300)	AL special color anod (199)	AL special color p-coat (399)
------------------	--	-------------------------------	-----------------------------	-------------------------------

Art. No.	Description	€/Piece	€/Piece	€/Piece	€/Piece	€/Piece
----------	-------------	---------	---------	---------	---------	---------

Set



**07.150 RS 120 Synchro Set**  
 For double leaf synchronously opening system,  
 max. panel width = 2 x 1000 mm,  
 max. weight = 80 kg per panel,  
 consisting of:  
 2 x accessory set 07.125  
 1 x deflexion accessory set incl. gear belt

610,00

**Track, sidelight profile, cover profile and view protection profile have to be ordered separately**

Single components



**07.118 Pair of gaskets (aluminium)**  
 for 12 mm glass thickness (for 2 clamping patches)

4,40



**07.122 Side panel profile without fixing holes,**  
 for 8, 10 and 12 mm glass  
 6000 mm stock length

€/m  
 34,00





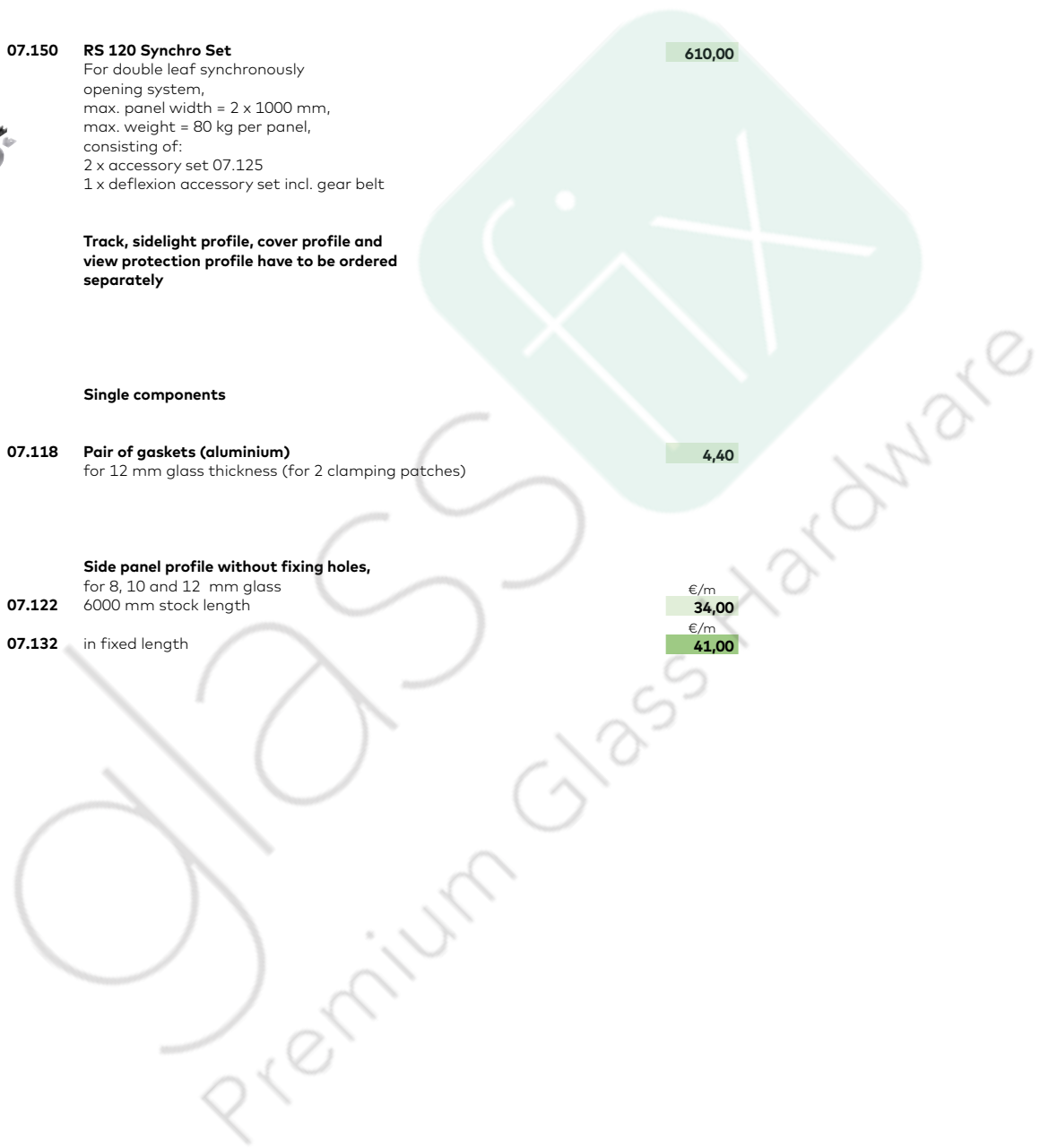

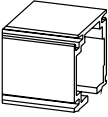

**07.132** in fixed length

€/m  
 41,00

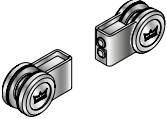

Sliding

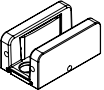
### Glass door with sidelight/s (8 and 10 mm), Synchro

Art. No.	Description	Base parts (000)	AL mill finish (100)	AL silver EV1 anod (101)	AL sim satin stain steel anod C31 (113)	AL traffic white p-coat (300)	AL special color anod (199)	AL special color p-coat (399)
<b>Single components</b>								
	<b>07.121</b> Track with fixing holes 6000 mm stock length	34,00						
	<b>07.131</b> in fixed length	41,00						
	<b>Cover profile (clip-on)</b> with connecting web for view protection cover profile 07.137/138 6000 mm stock length							
	<b>07.140</b> 6000 mm stock length		20,00	34,50	20,00	34,50	34,50	
	<b>07.141</b> in fixed length		25,00	43,00	25,00	43,00	43,00	
	<b>07.138</b> Bottom view protection cover profile 6000 mm stock length, (only in combination with sidelight profile 07.132 / 122 and cover profile 07.141 / 140)		8,50			13,50	13,50	
	<b>07.137</b> Bottom view protection cover profile, in fixed length, (only in combination with sidelight profile 07.132 / 122 and cover profile 07.141 / 140)		10,00			10,00	15,50	15,50
	<b>29.420</b> Door steady, to prevent glass edges of double sliding doors bumping into each other (glass preparation)	€/Pair 64,50						
	<b>21.431</b> Guide rail with brush seal, fixed length up to 6.000 mmm		49,00		61,00			
	<b>21.432</b> stock length 3.000 mm	€/Piece 117,00						
	<b>21.430</b> stock length 6.000 mm	€/Piece 219,00						
	<b>36.105</b> MUTO Floor guide infinitely adjustable for glass thicknesses up to 13,5 mm				(150) €/Piece 23,50	(157) €/Piece 26,00		
	<b>07.126</b> Floor guide	€/Piece 7,50						

Timber door (8 and 10 mm) for installation at wall and ceiling

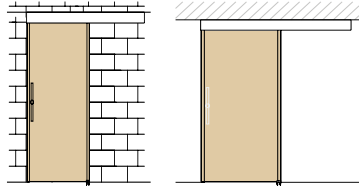

Art. No. Description

Base parts (000)	AL silver EV1 anod (101)	AL sim satin stain steel anod C31 (113)	AL traffic white p-coat (300)	AL special color anod (199)	AL special color p-coat (399)
€/m	€/m	€/m	€/m	€/m	€/m

Sliding

Set

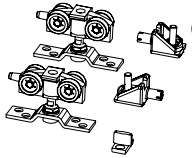

**07.135 Accessory set complete for timber applications,** consisting of:  
2 carriers  
2 end stops with safety catch  
1 floor guide

€/Piece  
**80,50**

Single components

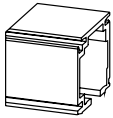

**07.121 Track with fixing holes**  
6000 mm stock length

**34,00**

**07.131** in fixed length

**41,00**



**07.140 Cover profile (clip-on)**  
with connecting web for view protection  
cover profile 07.137/138  
6000 mm stock length

**20,00 34,50 20,00 34,50 34,50**

**07.141** in fixed length

**25,00 43,00 25,00 43,00 43,00**



**07.226 Floor guide for timber door panel**

€/Piece  
**1,00**



# MANET



reddot design award

**Attention:** The products in this chapter are not allowed for structural glazings requiring approval in each individual case.



Technical data	
Glass	TSG (Compact), TSG and LSG (2 x TSG) (Concept)
Glass thickness	8, 10, 12 mm (Compact), 8 - 17 mm (Concept)
max. door panel weight	100 Kg (Compact), 120 Kg (Concept)
Applications	1-/2 panels (glass or timber), overpanel, sidelight, toughened glass assembly
Material	Stainless steel AISI 303 (stainless steel AISI 316 on request), (not for indoor swimming pools or salt-water pools)
Finishes	Satin stainless steel
Kind of installation	Installation at wall or glass
Specials	Readjustable without dismantling +2,5/-2,5 mm Single point fittings with clamping disc or countersunk

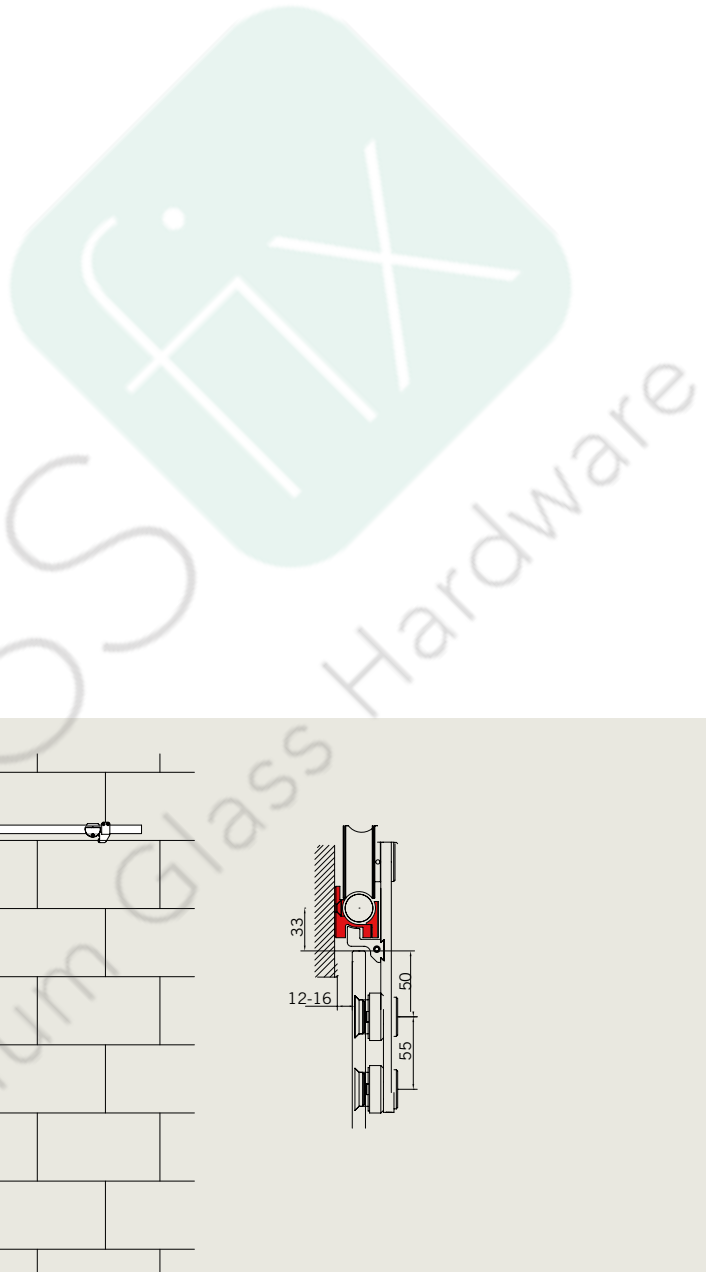

Example view for MANET Compact installation at wall

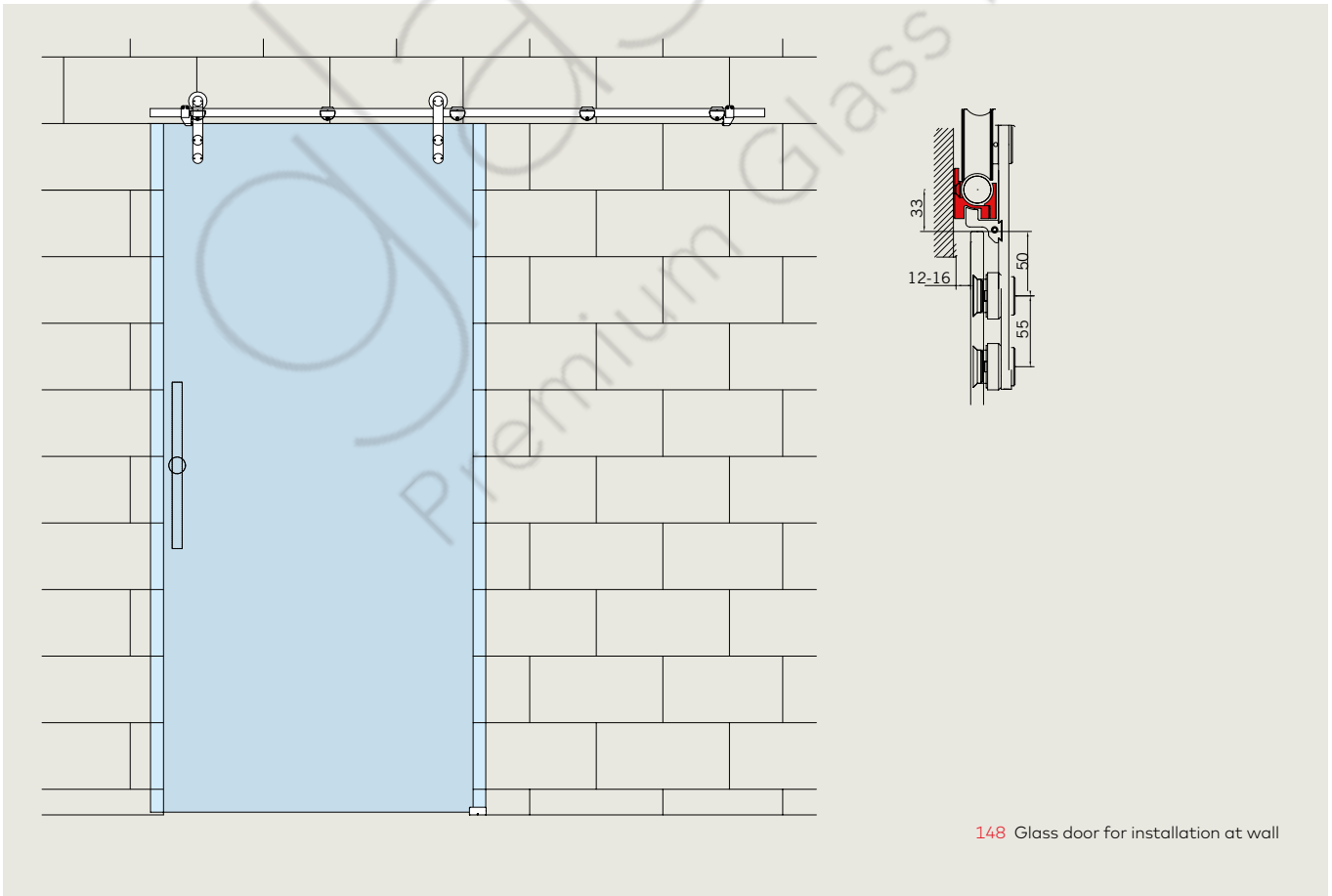

148 Glass door for installation at wall

**Example view for MANET Compact with glass overpanel and glass sidelight**

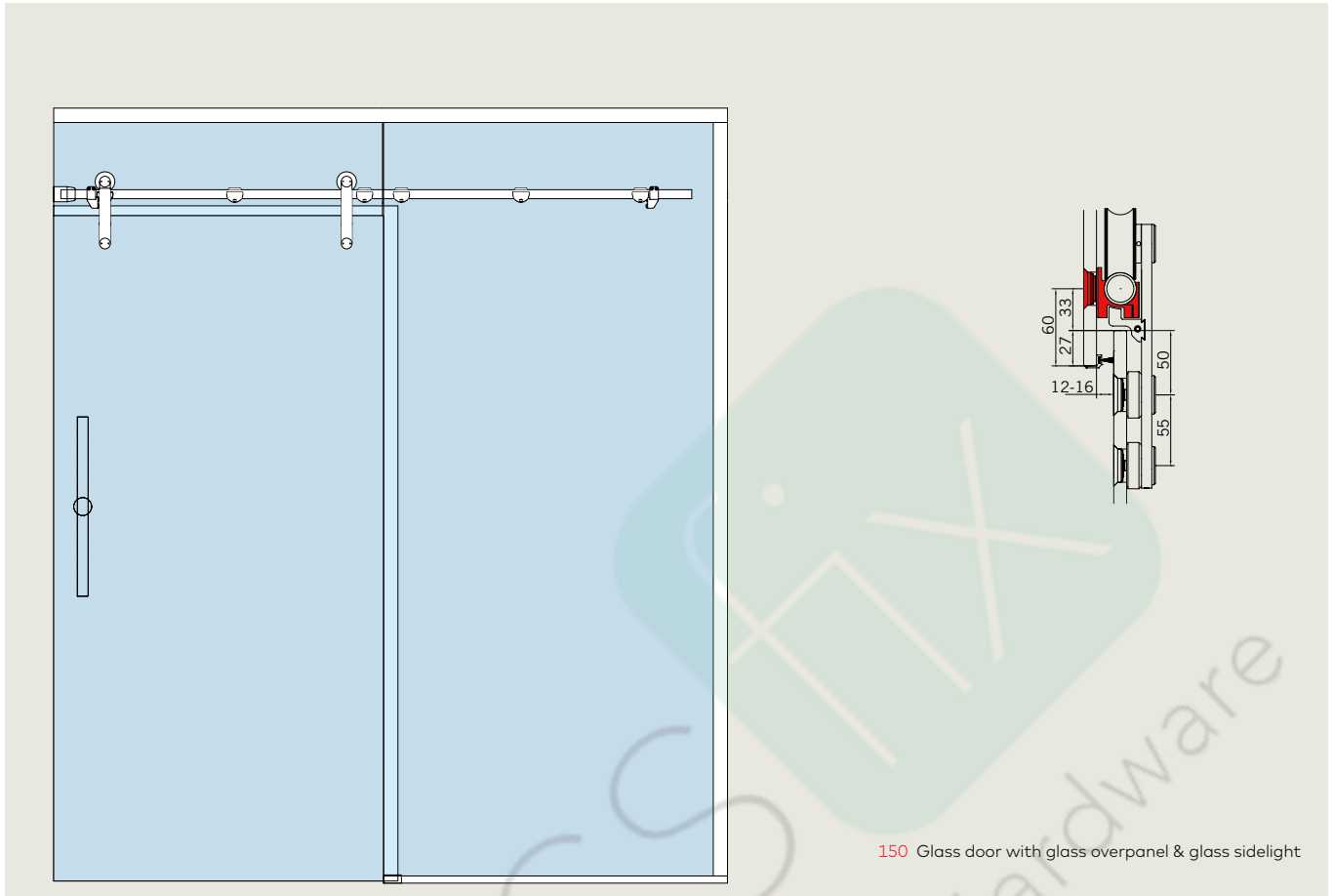

**Example view for MANET Compact with glass overpanel and glass sidelights**

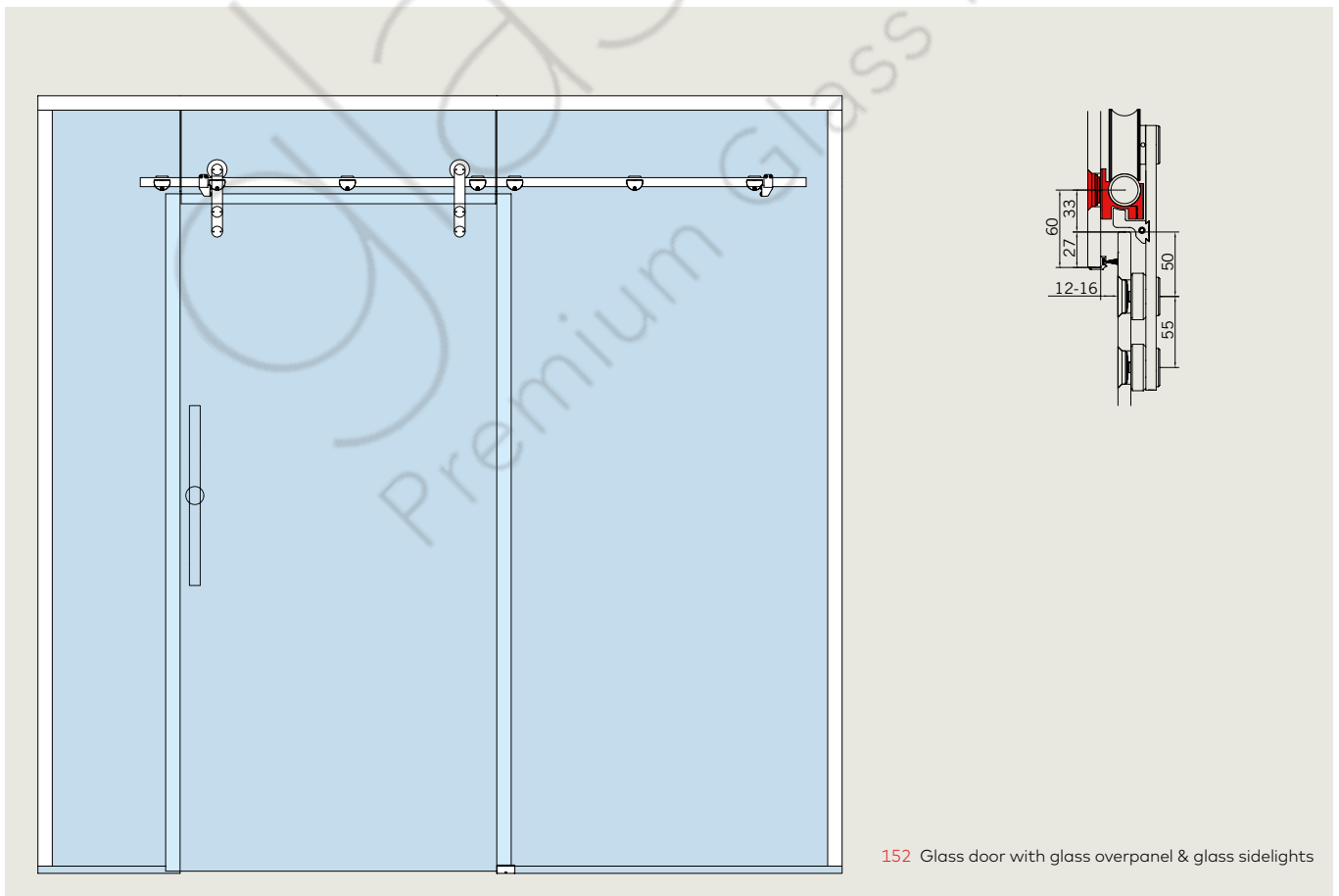

SET 4.1

Satin  
stainl  
steel  
(700)

Sliding

Art. No.	Description	€/Piece
<b>Complete set</b>		
<b>Sliding door MANET Compact for mounting to wall for 8 – 12 mm glass, countersunk single-point fixings</b>		
29.916	SET 4.1 with clamp brackets for fixing track to wall	725,00
29.925	SET 4.1 with 16 mm extended clamp brackets for fixing track to wall	734,00

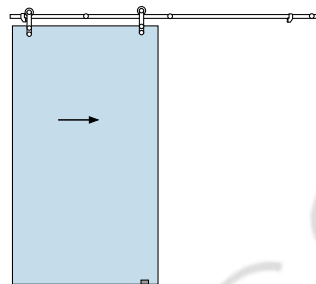

consisting of:  
5 Clamp brackets track/wall  
respectively  
5 Clamp brackets track/wall with 16 mm extended distance between wall and glass

2 Roller Classic carriers incl.  
single-point fixing 8 – 12 mm glass  
1 Door stop LH  
1 Door stop RH  
1 Floor guide

21.436	<b>Not covered by the set:</b> Sliding track tube in fixed length* incl. end plugs	€/m 37,00
--------	--	--------------



\* When ordering please indicate length!

**SET 4.2**

Satin  
stainl  
steel  
(700)

Sliding

Art. No.	Description	€/Piece
<b>Complete set</b>		
<b>Sliding door MANET Compact for mounting to wall for 8 – 12 mm glass, clamping disc single-point fixings</b>		
29.917	SET 4.2 with clamp brackets for fixing track to wall	741,00
29.926	SET 4.2 with 16 mm extended clamp brackets for fixing track to wall	753,00

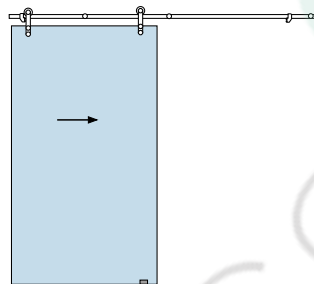

- consisting of:
- 5 Clamp brackets track/wall respectively
  - 5 Clamp brackets track/wall with 16 mm extended distance between wall and glass
  - 2 Roller Classic carriers incl. single-point fixing 8 – 12 mm glass
  - 1 Door stop LH
  - 1 Door stop RH
  - 1 Floor guide

21.436	<b>Not covered by the set:</b> Sliding track tube in fixed length* incl. end plugs	€/m 37,00
--------	--	--------------



\* When ordering please indicate length!

SET 5.1

Satin  
stainl  
steel  
(700)

Sliding

Art. No.	Description	€/Piece
<b>Complete set</b>		
	<b>Sliding door MANET Compact for mounting to glass, connected to wall on one side for 8 - 12 mm glass (sliding doors), 10 - 12 mm glass (fixed elements), countersunk single-point fixings</b>	
29.918	SET 5.1	<b>858,00</b>

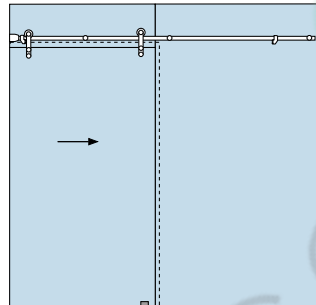

- consisting of:
- 6 Clamp brackets for glass, countersunk single-point fixing
  - 2 Roller Classic carriers incl. single-point fixing 8 - 12 mm glass
  - 1 Wall fixing
  - 1 Door stop LH
  - 1 Door stop RH
  - 1 Floor guide

**21.436** **Not covered by the set:**  
Sliding track tube in fixed length\*  
incl. end plugs

€/m  
**37,00**



\* When ordering please indicate length!

**SET 5.2**

Satin  
stainl  
steel  
(700)

Sliding

Art. No.	Description	€/Piece
<b>Complete set</b>		
<b>Sliding door MANET Compact for mounting to glass, connected to wall on one side for 8 - 12 mm glass (sliding doors), 10 - 12 mm glass (fixed elements), clamping disc single-point fixings</b>		
29.919	SET 5.2	948,00

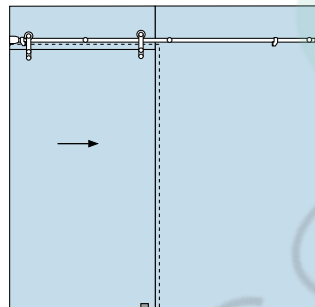

- consisting of:
- 6 Clamp brackets for glass, clamping disc single-point fixing
  - 2 Roller Classic carriers incl. single-point fixing 8 - 12 mm glass
  - 1 Wall fixing
  - 1 Door stop LH
  - 1 Door stop RH
  - 1 Floor guide

**21.436** **Not covered by the set:**  
Sliding track tube in fixed length\*  
incl. end plugs

€/m  
**37,00**



\* When ordering please indicate length!

SET 6.1

Satin  
stainl  
steel  
(700)

Sliding

Art. No. Description €/Piece

Complete set

**Sliding door MANET Compact  
for mounting to glass,  
sidelight both sides  
for 8 – 12 mm glass (sliding doors),  
10 – 12 mm glass (fixed elements),  
countersunk single-point fixings**

29.920 SET 6.1

899,00

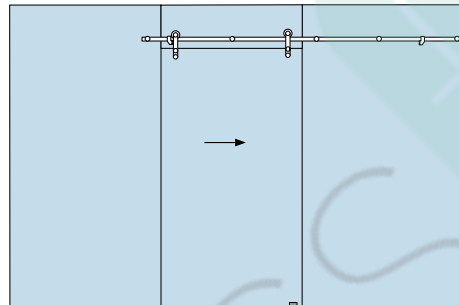

consisting of:

- 7 Clamp brackets for glass, countersunk single-point fixing
- 2 Roller Classic carriers incl. single-point fixing 8 – 12 mm glass
- 1 Door stop LH
- 1 Door stop RH
- 1 Floor guide

**21.436 Not covered by the set:**  
Sliding track tube in fixed length\*  
incl. end plugs

€/m  
37,00



\* When ordering please indicate length!



**SET 6.2**

Satin  
stainl  
steel  
(700)

Sliding

Art. No.	Description	€/Piece
<b>Complete set</b>		
<b>Sliding door MANET Compact for mounting to glass, sidelight both sides for 8 – 12 mm glass (sliding doors), 10 – 12 mm glass (fixed elements), clamping disc single-point fixings</b>		
29.921	SET 6.2	<b>955,00</b>

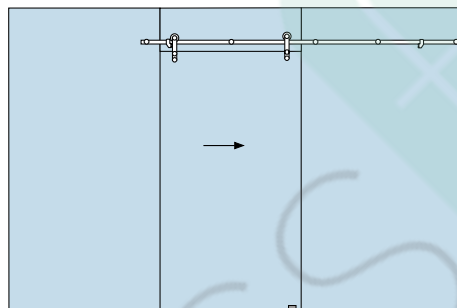

- consisting of:
- 7 Clamp brackets for glass, clamping disc single-point fixing
  - 2 Roller Classic carriers incl. single-point fixing 8 – 12 mm glass
  - 1 Door stop LH
  - 1 Door stop RH
  - 1 Floor guide

<b>21.436</b>	<b>Not covered by the set:</b> Sliding track tube in fixed length* incl. end plugs	€/m <b>37,00</b>
---------------	--	---------------------











\* When ordering please indicate length!

Accessories





Sliding

Base parts (000)  
Satin stainl steel (700)

Art. No.	Description	€/Piece	€/Piece
	<b>21.446 Sliding door lock with ratchet brace</b> for 10/12 mm glass (only AISI 316L)		<b>236,00</b>
	<b>21.448 Dead lock</b> for 8 - 12 mm glass		<b>94,50</b>
	<b>21.449 Dead lock with profile cylinder rose</b> on inside for 8 - 12 mm glass		<b>152,00</b>
	<b>05.194 Eccentric bushing</b> for dead lock 21.448 / 21.449 / 21.450		<b>23,00</b>
	<b>14.206 Profile cylinder</b> for dead lock 21.448 / 21.449		<b>21,00</b>
	<b>05.190 Strike plate</b>		<b>13,50</b>
	<b>29.217 5 pcs. of clip-on cover with spring for single-point fixing</b> <b>29.219 do. (AISI 316L)</b>		<b>21,00</b> <b>29,50</b>
	<b>21.134 Assembling tool for MANET</b> single-point fixings (also usable as nut for torque wrenches)		<b>12,50</b>
	<b>21.137 Hole gauge</b>		<b>20,00</b>

## Single components for Sliding doors

Satin  
stainl  
steel  
(700)

Art. No.	Description	€/Piece
<b>Components for sliding doors</b>		
	<b>29.422 Roller carrier CLASSIC*</b> only lug with roller including antijump mechanism for tube/solid track	149,00
	<b>29.423</b> do. (AISI 316L)	205,00
	<b>29.424 Roller carrier TREND*</b> only lug with roller including antijump mechanism for tube/solid track	202,00
<b>2 pcs. single-point fixing</b> for roller carrier TREND/CLASSIC		
	<b>29.430</b> countersunk for 8 - 12 mm glass	36,00
	<b>29.431</b> do. (AISI 316L)	65,00
	<b>29.432</b> clamping disc for 8 - 12 mm glass	37,00
	<b>29.433</b> do. (AISI 316L)	80,50
	<b>29.435</b> countersunk for 13.5-17.5 mm glass	47,00
	<b>29.437</b> countersunk for 19 mm glass	47,00
<b>Components for timber doors</b>		
<b>2 pcs. single-point fixing for roller carrier</b> TREND/CLASSIC 20 - 40 mm panel thickness,		
	<b>29.510</b> countersunk	38,00
	<b>29.520</b> clamping disc	51,00

\* When ordering the sliding door roller without track no guarantee for the function of the roller will be given.

Single components for Sliding doors









Sliding

Base parts (000)  
Satin stainless steel (700)

Art. No.	Description	€/Piece	€/Piece
<b>Solid sliding tracks and components</b>			
	<b>Track drilled</b> for glass fixing, fixed length up to 6,000 mm	€/m	<b>183,00</b>
	<b>21.405</b> <b>21.456</b> do. (AISI 316L)		<b>258,00</b>
	for wall fixing, fixed length up to 6,000 mm	€/m	<b>198,00</b>
	<b>21.406</b> <b>21.457</b> do. (AISI 316L)		<b>269,00</b>
	<b>Track undrilled</b> for fixing with clamp brackets fixed length up to 6,000 mm	€/m	<b>96,50</b>
	<b>21.407</b> <b>21.458</b> do. (AISI 316L)		<b>186,00</b>
	(For connection of tracks: single length max. 5,000 mm)		
	<b>21.404</b> <b>Connection for track 180°</b> , incl. frontal preparation in tracks		<b>116,00</b>
	<b>Angled connection for track</b> , 90° - 180°		
	<b>21.442</b> <b>21.443</b> incl. frontal preparation in tracks do. (AISI 316L)		<b>134,00</b> <b>163,00</b>
	<b>Single-point fixing</b> , track to glass, fixed, countersunk		
	<b>29.460</b> 10/12 mm glass		<b>16,50</b>
	<b>29.461</b> do. (AISI 316L)		<b>22,00</b>
	<b>29.450</b> 13.5 - 15.5 mm glass		<b>24,50</b>
	<b>29.451</b> 17.5 mm glass		<b>24,50</b>
<b>29.471</b> 8 mm glass (AISI 316L)		<b>44,00</b>	
	<b>Single-point fixing</b> , track to glass, fixed, clamping disc		
	<b>29.465</b> <b>29.466</b> 10/12 mm glass thickness do. (AISI 316L)		<b>32,50</b> <b>51,00</b>
	<b>Single-point fixing</b> , track to glass, fixed, countersunk, centred		
	<b>29.462</b> 10/12 mm glass thickness		<b>24,50</b>
	<b>29.463</b> do. (AISI 316L)		<b>31,00</b>
	<b>29.455</b> 13,5 - 15,5 mm glass thickness		<b>32,00</b>
	<b>29.456</b> 17,5 mm glass thickness		<b>32,00</b>
<b>29.473</b> 8 mm (AISI 316L)		<b>40,00</b>	

## Single components for Sliding doors

Satin  
stainl  
steel  
(700)

Art. No.	Description	€/Piece
 29.467	<b>Single-point fixing, track to glass,</b> centering, clamping disc, 10/12 mm glass	34,50
 21.346	<b>Flange fixing track to wall</b> do. (AISI 316L)	6,50
21.347		11,00
 21.412	<b>Flange fixing track to wall,</b> adjustable Attention: min. distance glass to wall 32 mm	31,50
 21.170	<b>Flange fixing for double track</b> 10 - 13,5 mm glass	18,00
 21.315	<b>Ceiling retainer for track,</b> carrying function, (AISI 316L)	164,00
 29.530	<b>Single-point fixing, track to glass,</b> 10/12 mm glass fixed for timber door panel 35 - 40 mm countersunk	32,50
 29.460	for timber door panel 20 - 30 mm countersunk clamping disc	16,50
29.465		32,50
 29.531	<b>Single-point fixing, track to glass,</b> 10/12 mm glass centering for timber door panel 35 - 40 mm countersunk	44,00
 29.462	for timber door panel 20 - 30 mm countersunk clamping disc	24,50
29.467		34,50

Sliding

Single components for Sliding doors





Satin  
stainl  
steel  
(700)

Sliding

Art. No.	Description	€/Piece
	<b>Sliding track tube incl. end caps</b> stock length 3,000 mm do. (AISI 316L)	<b>101,00</b> <b>187,00</b>
	21.527	€ / m
	21.530	<b>37,00</b> <b>69,00</b>
	21.436 fixed length up to 6,000 m do. (AISI 316L)	
	21.532	
	alternative: Solid track undrilled (see page 156)	
	<b>Sliding track tube, bent</b> r = min 600 mm max. curve length 2.6 m max. curve length 5.6 m	<b>381,00</b> <b>591,00</b>
	21.409	
	21.413	
	<b>29.505 Thread insert for sliding track tube</b> (for use with angled connection 21.535 / 21.536)	<b>18,50</b>
	<b>29.506 Connection sliding track tube</b>	<b>35,00</b>
	<b>21.535 Angled connection for track tube,</b> 90°-180°	
	<b>Clamp bracket, fixing track to glass,</b> countersunk single-point fixing for 10, 12 and 13.5 mm glass do. (AISI 316L)	<b>57,00</b> <b>81,50</b>
	29.176	
	29.185	
	<b>Clamp bracket, fixing track to glass,</b> clamping disc single-point fixing for 10, 12 and 13.5 mm glass do. (AISI 316L)	<b>60,00</b> <b>92,50</b>
	29.177	
	29.186	
	<b>29.175 Clamp bracket, fixing track to wall</b> do. (AISI 316L)	<b>42,50</b> <b>57,50</b>
	29.184	

## Single components for Sliding doors

Satin  
stainl  
steel  
(700)









Art. No.	Description	€/Piece
	<b>29.178</b> <b>Clamp bracket, fixing track to wall</b> with 16 mm extended distance between wall and glass	<b>49,00</b>
	<b>29.179</b> <b>Clamp bracket, fixing for track to glass,</b> for timber door panel 35 - 40 mm <b>29.180</b> countersunk clamping disc	<b>58,50</b> <b>69,00</b>
	<b>21.316</b> <b>Ceiling retainer for sliding track,</b> carrying function, (AISI 316L)	<b>235,00</b>
	<b>21.317</b> do. for double leaf sliding door	<b>276,00</b>

Single components for Sliding doors

Sliding



AL  
sim satin  
stainl steel  
anod C31  
(113)

Satin  
stainl  
steel  
(700)

Art. No.	Description	€/Piece	€/Piece
	<b>Aluminium brush profile,</b> for 8 mm glass, similar to satin stainless steel stock length 3,000 mm	<b>30,50</b>	
	<b>07.402</b>	€/m	
<b>07.403</b>	fixed length up to 6,000 mm	<b>17,50</b>	
	<b>Aluminium brush profile, for 10/12 mm glass,</b> similar to satin stainless steel stock length 3,000 mm	<b>30,50</b>	
	<b>07.400</b>	€/m	
<b>07.401</b>	fixed length up to 6,000 mm	<b>17,50</b>	
	<b>29.425</b> <b>Door stop left hand</b>	<b>83,00</b>	
	<b>29.427</b> do. (AISI 316L)	<b>135,00</b>	
	<b>29.426</b> <b>Door stop right hand</b>	<b>83,00</b>	
	<b>29.428</b> do. (AISI 316L)	<b>135,00</b>	
	<b>29.494</b> <b>Roller at glass</b> 8 - 12 mm glass, countersunk	<b>100,00</b>	
	<b>29.495</b> 8 - 12 mm glass, clamping disc	<b>105,00</b>	
	<b>29.493</b> <b>Door stop for roller at glass</b>	<b>71,00</b>	
	<b>29.483</b> do. (AISI 316L)	<b>115,00</b>	
	<b>29.497</b> <b>Anti-jump mechanism for roller at glass</b> 8 - 12 mm glass, countersunk	<b>79,50</b>	
	<b>29.498</b> 8 - 12 mm glass, clamping disc	<b>87,50</b>	
	<b>29.148</b> <b>Glass-glass connector</b> for 8 - 12 mm glass	<b>63,50</b>	
	<b>29.368</b> do. (AISI 316L)	<b>81,50</b>	

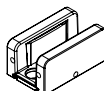

### Single components for Sliding doors

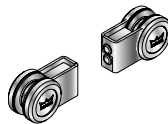

		Base parts (000)	AL mill finish (100)	AL sim satin stain steel anod C31 (113)	Satin stain steel (700)
Art. No.	Description	€/Piece	€/Piece	€/Piece	€/Piece
	<b>21.431</b> <b>Guide rail with brush seals,</b> fixed length up to 6,000 mm		€/m <b>49,00</b>	€/m <b>61,00</b>	
	<b>21.432</b> stock length 3,000 mm		<b>117,00</b>		
	<b>21.430</b> stock length 6,000 mm		<b>219,00</b>		
	<b>36.105</b> <b>MUTO Floor guide</b> infinitely adjustable for glass thicknesses up to 13,5 mm			(157) <b>26,00</b>	
	<b>07.226</b> <b>Floor guide for timber doors</b>		<b>1,00</b>		
	<b>29.445</b> <b>Wall fixing for solid tracks and tubes</b>				<b>43,50</b>
	<b>29.446</b> do. (AISI 316L)				<b>76,00</b>
	<b>29.420</b> <b>Door steady,</b> to prevent glass edges of double sliding doors bumping into each other		€/Pair <b>64,50</b>		
	<b>29.221</b> <b>Anti-jump device</b> Packing unit: 2 Pcs.				<b>31,50</b>

Sliding

Single-point fixings

Sliding

Satin  
stainl  
steel  
(700)

Art. No.	Description	€/Piece
	<b>20.601</b> Single-point fixing Ø 24 glass / wall, adjustable, M6-fixing screw	14,00
	<b>20.611</b> Single-point fixing Ø 24 glass / wall with base flange 4 mm, adjustable, M6-fixing screw	25,00
	<b>Single-point fixing, S32/35 series glass/wall, countersunk</b>	
	<b>not adjustable, fixed distance to wall 6 mm</b>	
	<b>29.205</b> 8/10 mm glass	19,00
	<b>29.215</b> 12 mm glass	23,00
	<b>29.243</b> 13.5 mm glass	24,50
	<b>29.247</b> 15 mm glass	26,00
	<b>29.251</b> 17.5 mm glass	27,00
	<b>adjustable, fixed distance to wall 8.5 - 11.5 mm</b>	
	<b>29.200</b> 8/10 mm glass	28,00
	<b>29.210</b> 12 mm glass	32,00
	<b>29.240</b> 13.5 mm glass	33,50
	<b>29.244</b> 15 mm glass	35,00
	<b>29.248</b> 17.5 mm glass	36,00
	<b>adjustable, fixed distance to wall 11.5 - 14.5 mm</b>	
	<b>29.201</b> 8/10 mm glass	28,00
	<b>29.211</b> 12 mm glass	32,00
	<b>29.241</b> 13.5 mm glass	33,50
	<b>29.245</b> 15 mm glass	35,00
	<b>29.249</b> 17.5 mm glass	36,00
	<b>adjustable, fixed distance to wall 14.5 - 22 mm</b>	
	<b>29.202</b> 8/10 mm glass	28,00
	<b>29.212</b> 12 mm glass	32,00
	<b>29.242</b> 13.5 mm glass	33,50
	<b>29.246</b> 15 mm glass	35,00
	<b>29.250</b> 17.5 mm glass	36,00

## Single-point fixings









Satin  
stainl  
steel  
(700)

Art. No.	Description	€/Piece
	<b>Single-point fixing, S32/35 series glass/wall, clamping disc</b>	
	<b>not adjustable, fixed distance to wall 6 mm</b>	
29.730	8/10 mm glass	23,00
29.731	12 mm glass	27,50
29.732	13.5 mm glass	29,50
29.733	15 mm glass	31,00
29.734	17.5 mm glass	32,50
	<b>adjustable, fixed distance to wall 8.5 - 11.5 mm</b>	
29.700	8/10 mm glass	34,00
29.705	12 mm glass	38,50
29.710	13.5 mm glass	39,50
29.715	15 mm glass	41,50
29.720	17.5 mm glass	43,00
	<b>adjustable, fixed distance to wall 11.5 - 14.5 mm</b>	
29.701	8/10 mm glass	34,00
29.706	12 mm glass	38,50
29.711	13.5 mm glass	39,50
29.716	15 mm glass	41,50
29.721	17.5 mm glass	43,00
	<b>adjustable, fixed distance to wall 11.5 - 14.5 mm</b>	
29.702	8/10 mm glass	34,00
29.707	12 mm glass	38,50
29.712	13.5 mm glass	39,50
29.717	15 mm glass	41,50
29.722	17.5 mm glass	43,00

Connectors

Sliding

Satin  
stainl  
steel  
(700)

Art. No.	Description	€/Piece
	<b>Pivoting glass clamp</b> inclusive screw sets for 8 - 12, 13.5 - 17.5 and 17.5 - 21.5 mm glass	
 29.160		27,50
29.165	do., clamping disc	36,00
 21.141	<b>Pivoting wall fixing</b>	34,50
 29.149	<b>Clamping connector</b> for 8 - 12 mm glass	59,00
	<b>Connecting rods</b>	
 21.355	Length 52.5 mm	22,00
21.356	Length 60 mm	22,00
21.357	Length 82 mm	22,00
21.358	Length 103 mm	22,00
 21.146	<b>Column ceiling/floor fixing</b>	43,00
 29.145	<b>Glass/ceiling or glass/floor</b> connector 90°, for 8 - 12 mm glass (only supporting, no carrying function)	64,50
	<b>Ceiling connector</b> (carrying function max. 35 kg/piece) for 8 - 12 mm glass	
 29.337	with countersunk single-point fixing do. (AISI 316L)	101,00
29.339		159,00
29.338	with clamping disc single-point fixing	106,00
	<b>Glass/glass corner connector</b> 90°-180°, for 8 - 12 mm glass, with connecting rod	
 29.120	52.5 mm	78,00
29.122	60 mm	78,00
29.125	82 mm	78,00
29.130	103 mm	78,00
	<b>Glass/wall corner connector</b> 90°-180°, for 8 - 12 mm glass, with connecting rod	
 29.139	52.5 mm	83,50
29.140	60 mm	83,50
29.142	82 mm	83,50

# RSP 80



Technical data	
Glass	TSG
Glass thickness	8, 10 mm
max. door panel weight	80 kg
Applications	1-/2 panels, glass and timber panels
Material	Aluminium
Finishes	EV1 Deco
Kind of installation	Installation at wall
Specials	tested according DIN EN 1527 Readjustable without dismantling +2,5/-2,5 mm

Example view for RSP 80 installation at wall

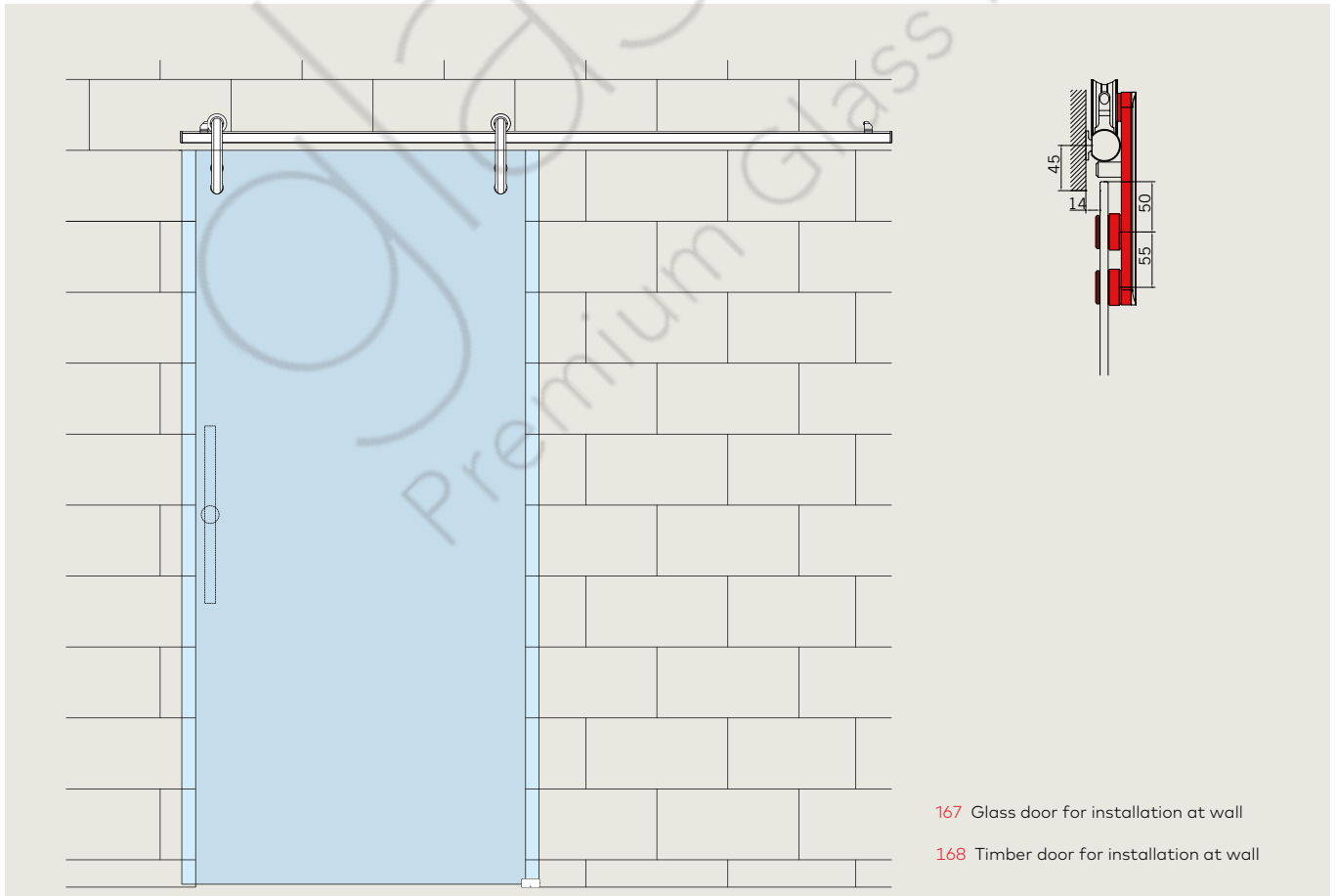

- 167 Glass door for installation at wall
- 168 Timber door for installation at wall

## Glass door (8 and 10 mm) for installation at wall

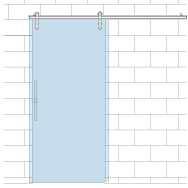

AL  
silver  
anod  
(150)

AL  
EV1-Deco  
anod  
(114)

Art. No.	Description	€/Piece	€/Piece
	<b>30.700 Complete set</b>  <b>RSP 80 Sliding door set</b> for 8 mm and 10 mm glass consisting of track profile for max. panel width 1080 mm, roller carriers, stops and floor guide		<b>504,00</b>
	<b>Set</b>		
	<b>30.701 RSP 80 accessory set for glass doors</b> consisting of roller carriers, stops and floor guide		<b>386,00</b>
	<b>Single components</b>		
	<b>30.705 RSP 80 track profile for mounting to wall</b> stock length 6000 mm	€/m	<b>63,50</b>
	<b>30.706</b> in fixed length (Recommendation: The door width should not go below 800 mm; this means normally a track length of ca. 1600 mm.)	€/m	<b>74,50</b>
	<b>36.105 MUTO Floor guide</b> infinitely adjustable for glass thicknesses up to 13,5 mm		<b>23,50</b>

Timber door (25 – 40 mm) for installation at wall

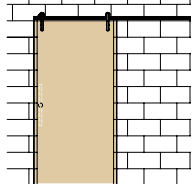

Base parts (000) AL EV1-Deco anod (114)

Art. No. Description €/Piece €/Piece

Complete set

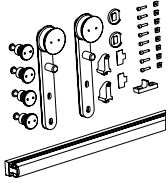

30.707 RSP 80 Sliding door set for timber applications track profile for max. panel width 1080 mm, roller carriers, stops and floor guide

504,00

Set

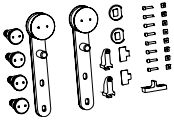

30.708 RSP 80 accessory set for timber applications consisting of roller carriers, stops and floor guide

386,00

Single components

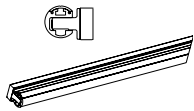

30.712 RSP 80 track profile for mounting to wall stock length 6000 mm

€/m 63,50

30.713 in fixed length (Recommendation: The door width should not go below 800 mm; this means normally a track length of ca. 1600 mm.)

€/m 74,50



07.226 Floor guide for timber door panel

1,00



Sliding



Notes



# CS 80 MAGNEO

Sliding



Technical data	
Glass	TSG
Glass thickness	8, 10, 12 mm
Max. door weight	80 kg
Applications	Single-panel, side lights, at glass
Material	Aluminium
Finishes	EV1
Kind of installation	On-wall/In-wall/Glass-to-glass
Specials	Near-silent operation thanks to mag-lev technology Locking function in accordance with standards DIN 18650, ANSI and BSI

Example view for CS 80 MAGNEO on-wall installation

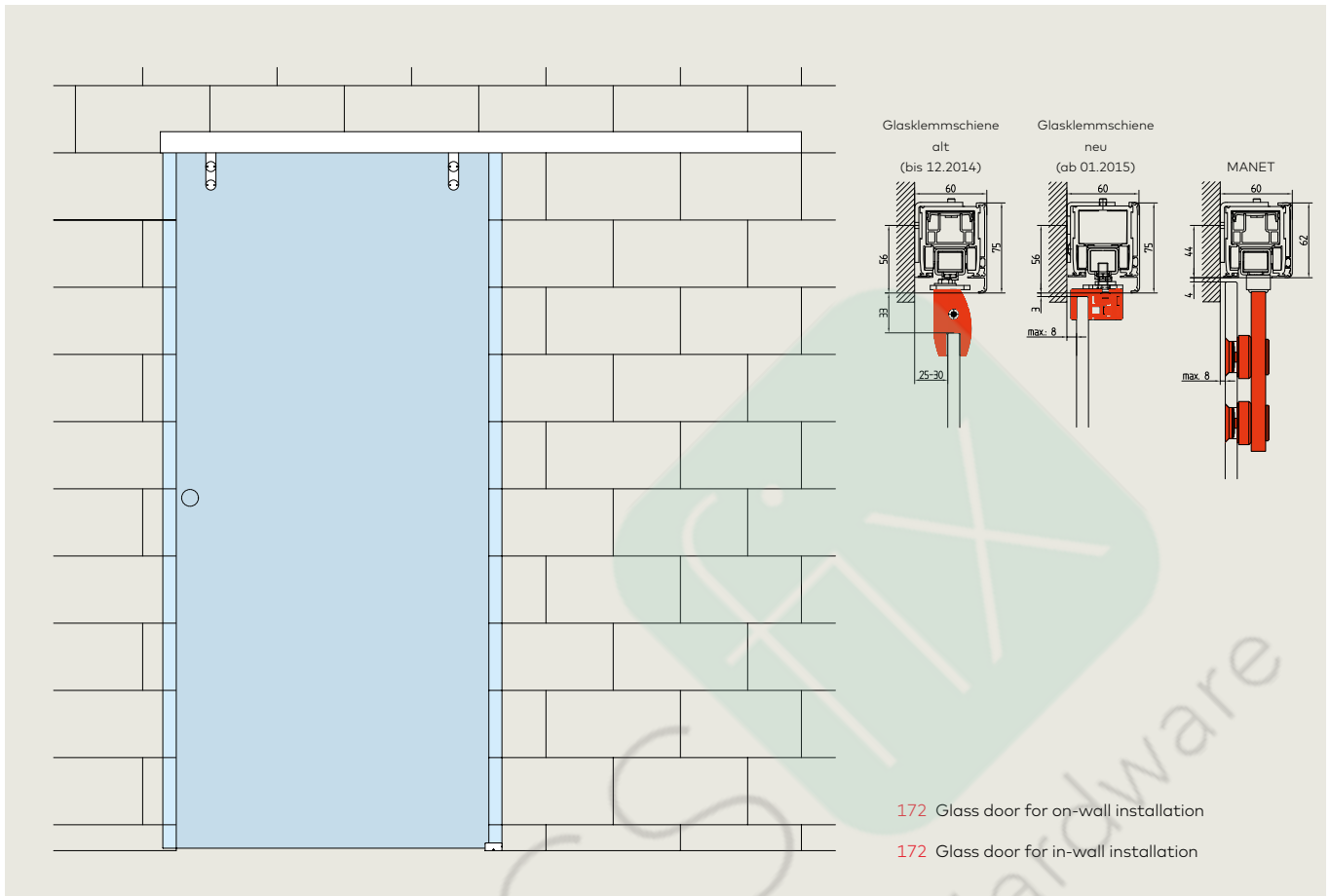

Sliding

Example view for CS 80 MAGNEO on glass overpanel and with glass side screen(s)/side light(s)

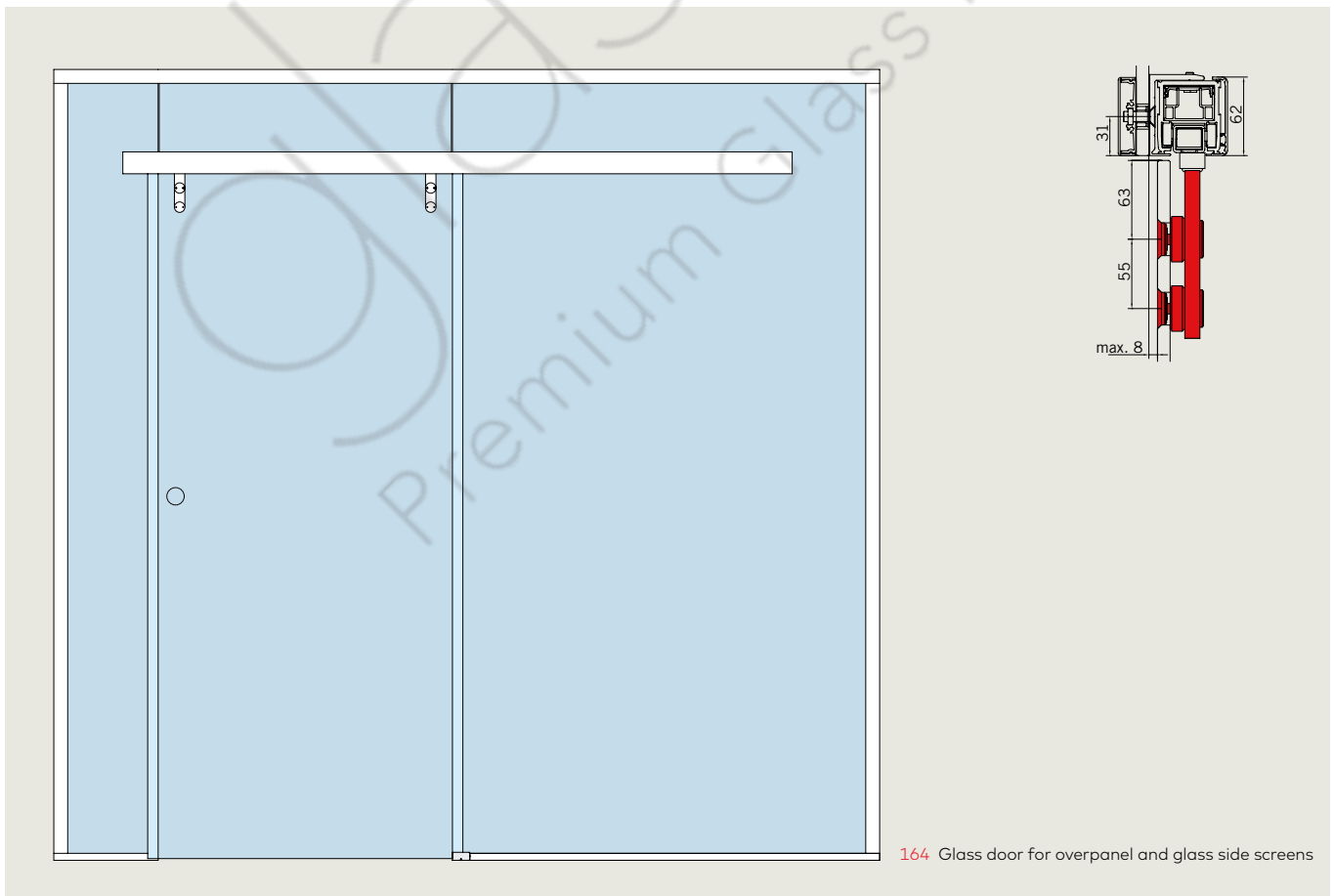

## Glass door for in-wall installation/on-wall installation

AL  
silver EV1  
anod  
(101)

Art. No.	Description	€/Piece
----------	-------------	---------

**Examples of complete sets****Operator packages CS 80 MAGNEO 1.1 for on-wall installation / MANET**

CS 80 MAGNEO operator with cover and MANET fixing kit, MANET door kit, power supply cable and floor guide, track length (excluding cover) 1,750 mm, for a max. travel of 875 mm  
Comprising: 84010001, 84000061, 84000077, 84020040

CS 80 MAGNEO operator with cover and MANET fixing kit, MANET door kit, power supply cable and floor guide, track length (excluding cover) 2,000 mm, for a max. travel of 1,000 mm  
Comprising: 84010002, 84000062, 84000077, 84020040

CS 80 MAGNEO operator with cover and MANET fixing kit, MANET door kit, power supply cable and floor guide, track length (excluding cover) 2,250 mm, for a max. travel of 1,125 mm  
Comprising: 84010003, 84000063, 84000077, 84020040

**Operator packages CS 80 MAGNEO 1.2, on-wall installation, glass clamping rail**

CS 80 MAGNEO operator with cover and glass clamping rail fixing kit, glass clamping rail door kit, power supply cable and floor guide, track length (excluding cover) 1,750 mm, for a max. travel of 875 mm  
Comprising: 84010001, 84000051, 84000079, 84020040

CS 80 MAGNEO operator with cover and glass clamping rail fixing kit, glass clamping rail door kit, power supply cable and floor guide, track length (excluding cover) 2,000 mm, for a max. travel of 1,000 mm  
Comprising: 84010002, 84000052, 84000080, 84020040

CS 80 MAGNEO operator with cover and glass clamping rail fixing kit, glass clamping rail door kit, power supply cable and floor guide, track length (excluding cover) 2,250 mm, for a max. travel of 1,125 mm  
Comprising: 84010003, 84000053, 84000081, 84020040

**Operator package CS 80 MAGNEO 1.3, in-wall installation / glass clamping rail**

CS 80 MAGNEO operator with glass clamping rail door kit and power supply cable, track length 1,750 mm, for a max. travel of 875 mm Comprising: 84010001, 84000079, 84020040

CS 80 MAGNEO operator with glass clamping rail door kit and power supply cable, track length 2,000 mm, for a max. travel of 1,000 mm Comprising: 84010002, 84000080, 84020040

CS 80 MAGNEO operator with glass clamping rail door kit and power supply cable, track length 2,250 mm, for a max. travel of 1,125 mm Comprising: 84010032, 84000081, 84020040

**In order to determine the lengths required, please use the formula shown on page 181.  
The profiles are unmachined and drilling work will need to be carried out on site.**

LV1: Clear passage width 875 mm, operator length or track length 1,750 mm

LV2: Clear passage width 1,000 mm, operator length or track length 2,000 mm

LV3: Clear passage width 1,125 mm, operator length or track length 2,250 mm

## Glass door for in-wall installation/on-wall installation

AL  
silver EV1  
anod  
(101)

Art. No.	Description	€/Piece
<b>Examples of complete sets</b>		
<b>Operator packages CS 80 MAGNEO 1.4 for on-wall installation / timber panels</b>		
<p>CS 80 MAGNEO operator with cover and timber panel fixing kit, timber panels, power supply cable and floor guide, track length (excluding cover) 1,750 mm, for a max. travel of 875 mm Comprising: 84010001, 8400001, 84000071, 84020040</p>		
<p>CS 80 MAGNEO operator with cover and timber panel fixing kit, timber panels, power supply cable and floor guide, track length (excluding cover) 2,000 mm, for a max. travel of 1,000 mm Comprising: 84010002, 84000052, 84000071, 84020040</p>		
<p>CS 80 MAGNEO operator with cover and timber panel fixing kit, timber panels, power supply cable and floor guide, track length (excluding cover) 2,250 mm, for a max. travel of 1,125 mm Comprising: 84010003, 84000053, 84000071, 84020040</p>		
<b>Operator package CS 80 MAGNEO 1.5, in-wall installation / timber panels</b>		
<p>CS 80 MAGNEO operator with timber panel door kit and power supply cable, track length 1,750 mm, for a max. travel of 875 mm Comprising: 84010001, 8400071, 84020040</p>		
<p>CS 80 MAGNEO operator with timber panel door kit and power supply cable, track length 2,000 mm, for a max. travel of 1,000 mm Comprising: 84010002, 8400071, 84020040</p>		
<p>CS 80 MAGNEO operator with timber panel door kit and power supply cable, track length 2,250 mm, for a max. travel of 1,125 mm Comprising: 84010003, 8400071, 84020040</p>		
<p><b>In order to determine the lengths required, please use the formula shown on page 181. The profiles are unmachined and drilling work will need to be carried out on site</b></p>		
<p>LV1: Clear passage width 875 mm, operator length or track length 1,750 mm LV2: Clear passage width 1,000 mm, operator length or track length 2,000 mm LV3: Clear passage width 1,125 mm, operator length or track length 2,250 mm</p>		

Glass door for glass-to-glass installation / glass overpanels and glass side screens

AL  
silver EV1  
anod  
(101)

Art. No. Description €/Piece

**Modular system components**

**Operator packages, CS 80 MAGNEO 1.6, glass-to-glass installation / glass clamping rail**

CS 80 MAGNEO operator with cover and glass clamping rail fixing kit, glass clamping rail door kit, power cable and floor guide, glass-to-glass installation set, mounting profile, internal cover, retaining profile, cover profile, operator length in total (including end covers): 1,840 mm, for a max. travel of 875 mm  
Comprising: 84010001, 84020006, 84000079, 84020074, 34002799140 x 1,840 mm, 34002899140 x 1,840 mm, 34002999140 x 1,840 mm, 34003099140 x 1,840 mm

CS 80 MAGNEO operator with cover and glass clamping rail fixing kit, glass clamping rail door kit, power cable and floor guide, glass-to-glass installation set, mounting profile, internal cover, retaining profile, cover profile, operator length in total (including end covers): 2,090 mm, for a max. travel of 1,000 mm  
Comprising: 84010002, 84020006, 84000080, 84020074, 34002799140 x 2,090 mm, 34002899140 x 2,090 mm, 34002999140 x 2,090 mm, 34003099140 x 2,090 mm

CS 80 MAGNEO operator with cover and glass clamping rail fixing kit, glass clamping rail door kit, power cable and floor guide, glass-to-glass installation set, mounting profile, internal cover, retaining profile, cover profile, operator length in total (including end covers): 2,340 mm, for a max. travel of 1,125 mm  
Comprising: 84010003, 84020006, 84000081, 84020074, 34002799140 x 2,340 mm, 34002899140 x 2,340 mm, 34002999140 x 2,340 mm, 34003099140 x 2,340 mm

**Operator packages, CS 80 MAGNEO 1.7, glass-to-glass installation / MANET**

CS 80 MAGNEO operator with cover and MANET fixing kit, MANET door kit, power cable and floor guide, glass-to-glass installation set, mounting profile, internal cover, retaining profile, cover profile, operator length in total (including end covers): 1,840 mm, for a max. travel of 875 mm  
Comprising: 84010001, 84020006, 84000072, 84020071, 34002799140 x 1,840 mm, 34002899140 x 1,840 mm, 34002999140 x 1,840 mm, 34003099140 x 1,840 mm

CS 80 MAGNEO operator with cover and MANET fixing kit, MANET door kit, power cable and floor guide, glass-to-glass installation set, mounting profile, internal cover, retaining profile, cover profile, operator length in total (including end covers): 2,090 mm, for a max. travel of 1,000 mm  
Comprising: 84010002, 84020006, 84000072, 84020071, 34002799140 x 2,090 mm, 34002899140 x 2,090 mm, 34002999140 x 2,090 mm, 34003099140 x 2,090 mm

CS 80 MAGNEO operator with cover and MANET fixing kit, MANET door kit, power cable and floor guide, glass-to-glass installation set, mounting profile, internal cover, retaining profile, cover profile, operator length in total (including end covers): 2,340 mm, for a max. travel of 1,125 mm  
Comprising: 84010003, 84020006, 84000072, 84020071, 34002799140 x 2,340 mm, 34002899140 x 2,340 mm, 34002999140 x 2,340 mm, 34003099140 x 2,340 mm

**In order to determine the lengths required, please use the formula shown on page 181.  
The profiles are unmachined and drilling work will need to be carried out on site.**

LV1: Clear passage width 875 mm, operator length or track length 1,750 mm  
LV2: Clear passage width 1,000 mm, operator length or track length 2,000 mm  
LV3: Clear passage width 1,125 mm, operator length or track length 2,250 mm

Single components

Base parts (000)  
AL silver EV1 anod (101)  
AL sim satin stainl steel anod (107)

Sliding

Modular system components

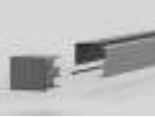
	<b>84010001</b>	<b>CS 80 MAGNEO operator incl. in-wall installation set</b> <b>Standard length LV1:</b> Operator length 1,750 mm without, or 1,840 mm with cover Clear passage width = 875 mm, operator length 1,750 mm	X	
	<b>84010002</b>	<b>Standard length LV2:</b> Operator length 2,000 mm without, or 2,090 mm with cover Clear passage width = 1,000 mm, operator length 2,000 mm	X	
	<b>84010003</b>	<b>Standard length LV3:</b> Operator length 2,250 mm without, or 2,340 mm with cover Clear passage width = 1,125 mm, operator length 2,250 mm	X	
	<b>84000051</b>	<b>Cover and fixing kit for timber panels and glass clamping rail</b> <b>Standard length LV1</b> Clear width = 875 mm, Operator length 1.750 mm		(101) X
	<b>84000052</b>	<b>Standard length LV2</b> Clear width = 1.000 mm, Operator length 2.000 mm		X
	<b>84000053</b>	<b>Standard length LV3</b> Clear width = 1.125 mm, Operator length 2.250 mm		X
	<b>84000054</b>	<b>Standard length LV1</b> Clear width = 875 mm, Operator length 1.750 mm		(107) X
	<b>84000055</b>	<b>Standard length LV2</b> Clear width = 1.000 mm, Operator length 2.000 mm		X
	<b>84000056</b>	<b>Standard length LV3</b> Clear width = 1.125 mm, Operator length 2.250 mm		X
	<b>84000061</b>	<b>Cover and fixing kit for MANET</b> <b>Standard length LV1</b> Clear width = 875 mm, Operator length 1.750 mm		(101) X
	<b>84000062</b>	<b>Standard length LV2</b> Clear width = 1.000 mm, Operator length 2.000 mm		X
	<b>84000063</b>	<b>Standard length LV3</b> Clear width = 1.125 mm, Operator length 2.250 mm		X
	<b>84000064</b>	<b>Standard length LV1</b> Clear width = 875 mm, Operator length 1.750 mm		(107) X
	<b>84000065</b>	<b>Standard length LV2</b> Clear width = 1.000 mm, Operator length 2.000 mm		X
	<b>84000066</b>	<b>Standard length LV3</b> Clear width = 1.125 mm, Operator length 2.250 mm		X
	<b>84000071</b>	<b>Timber panel door kit incl. floor guides</b>	X	
	<b>84000078</b>	<b>MANET door kit</b> incl. floor guides, alu silver EV1		(101) X
	<b>84000077</b>	<b>MANET door kit</b> incl. floor guides, alu sim. to satinised s/s		(107) X
	<b>84000079</b>	<b>Door kit, glass clamping rail incl. floor guides</b> <b>Standard length LV1</b> Clear width = 875 mm, Operator length 1.750 mm		(101) X
	<b>84000080</b>	<b>Standard length LV2</b> Clear width = 1.000 mm, Operator length 2.000 mm		X
	<b>84000081</b>	<b>Standard length LV3</b> Clear width = 1.125 mm, Operator length 2.250 mm		X
	<b>84000082</b>	<b>Standard length LV1</b> Clear width = 875 mm, Operator length 1.750 mm		(107) X
	<b>84000083</b>	<b>Standard length LV2</b> Clear width = 1.000 mm, Operator length 2.000 mm		X
	<b>84000084</b>	<b>Standard length LV3</b> Clear width = 1.125 mm, Operator length 2.250 mm		X
	<b>84020124</b>	<b>Backplate</b> <b>Standard length LV1</b> Clear width = 875 mm, Operator length 1.750 mm	X	
	<b>84020125</b>	<b>Standard length LV2</b> Clear width = 1.000 mm, Operator length 2.000 mm	X	
	<b>84020126</b>	<b>Standard length LV3</b> Clear width = 1.125 mm, Operator length 2.250 mm	X	

Single components

Sliding











Base parts (000) AL silver EV1 anod (101) AL sim satin stainl steel anod (107)

Art. No.	Description	€/Piece	€/Piece
<b>Accessories</b>			
	84020101 <b>Recessed pull grips for timber and glass doors</b> , alu. silver EV 1		X
	84020102 <b>Recessed pull grips for timber and glass doors</b> , alu. sim. to satinised s/s		X
<b>Operator and door panel accessories</b>			
84020130	<b>Locking device</b> (failsafe/failsecure) To be used only in combination with program switch EPS-S3, Art. No. 16605501150		X
84020002	<b>Fixing set for in-wall installation</b>		X
<b>Operator fixing set, on-wall installation</b>			
84020003	<b>Standard length LV1</b> Clear width = 875 mm, Operator length 1.750 mm		X
84020004	<b>Standard length LV2</b> Clear width = 1.000 mm, Operator length 2.000 mm		X
84020005	<b>Standard length LV3</b> Clear width = 1.125 mm, Operator length 2.250 mm		X
84020006	<b>Glass-to-glass installation set</b> , alu silver EV1		X
84020007	<b>Glass-to-glass installation set</b> , alu sim. to satinised s/s (Operator fixing set: screws, protective film and plastic grommets)		X
84020040	<b>Power supply cable</b> For 230V +/- 10%		X
	<b>End covers</b>		
	84020071	Height 62 mm (MANET), alu silver EV1	X
	84020072	Height 62 mm (MANET), alu sim. to satinised s/s	X
	84020074	Height 75 mm (glass clamping rail + timber), alu silver EV1	X
	84020075	Height 75 mm (glass clamping rail + timber), alu sim. to satinised s/s	X
84020090	<b>Cover profile set for wall connection</b>		X
84020112	<b>Guide rail, timber panels, for LV3</b> Length 1,125 mm		X
84020123	<b>Floor guide, in-wall installation</b> for timber panels		X
92212001	<b>Floor slider guide on board (frame)</b>		X
33438001150	<b>Floor guide, external configuration (glass)</b>		X



## Single components



Base  
parts  
(000)

Art. No.	Description	€/Piece
<b>Accessories for switch-type convenience activators, wired</b>		
	<b>19144701170 Flush switch S55</b> white, with frame-type trim	X
	<b>16605501150 Program switch EPS-S3</b> 3-position, electronic, S55, flush, Off-Automatic-Permanent Open	X
	<b>16610601175 Internal program switch, MAGNEO</b> Only for wall-face installation, integrated in the end cover	X
	<b>5076831332 Magic Switch</b> Proximity radar switch, concealed, incl. flush-mounting box	X
<b>Accessories for radio-type convenience activators</b>		
	<b>29302002</b> Radio receiver BRC-R	X
	<b>84020081</b> Radio pushbutton accessory set, always needed with radio technique	X
	<b>29301004 Hand-held transmitter BRC-H</b> DORMA bi-directional hand-held transmitter BRC-H for radio remote control, battery-operated, two channels with feedback LED, shock-proof design with DORMA fob, for use in conjunction with the DORMA radio receiver BRC-R, Art. No. 29302002 and additional radio push-button set 84020081	X
	<b>29304001 Hand-held transmitter BRC-H</b> DORMA bi-directional hand-held transmitter BRC-H for radio remote control, battery-operated, four channels with feedback LED, shock-proof design with DORMA fob, for use in conjunction with the DORMA radio receiver BRC-R, Art. No. 29302002 and additional radio push-button set 84020081 Requisite battery type: 1 x 1.5 V LR03 (AAA)	X
	<b>29301005 Wall-mounted transmitter BRC-W</b> DORMA bi-directional wireless wall-mounted transmitter BRC-W for radio control, battery-operated, incl. toggle switch and frame-type trim, similar to 55 mm design, of white plastics, can either be screwed to the substrate or integrated in existing System 55 device box, suitable for internal use, light-duty, for use in conjunction with the DORMA radio receiver BRC-R Art. No. 29302002, and additional radio push-button set 84020081, Requisite battery type, 2 x 1.5V LR03 (AAA)	X
	<b>29301003 Concealed transmitter BRC-T</b> DORMA bi-directional flush-mounted radio transmitter BRC-T, battery-operated, for installation in a switch with a deep flush-mounting box or a surface-mounted elbow switch/switch pad. Also suitable for heavy-duty applications In conjunction with DORMA stainless steel elbow switches; only suitable for use in conjunction with the DORMA radio receiver BRC-R, Art. No. 29302002 and additional radio push-button set 84020081	X

Single components

Sliding

Base parts (000)   Plastic black (803)   Plastic satin chromed (804)   Plastic traffic white (805)

Art.-Nr.	Description	€/Piece	€/Piece	€/Piece	€/Piece
<b>Single components</b>					
	<b>86113000</b> Radar motion detector Prosecure Opti-Motion Stereo, white				X
	<b>86112000</b> Radar motion detector Prosecure Opti-Motion Stereo, silver			X	
	<b>86111000</b> Radar motion detector Prosecure Opti-Motion Stereo, black		X		
<b>84020030</b>	Auxiliary sensor mounting bracket	X			
		X			
		X			

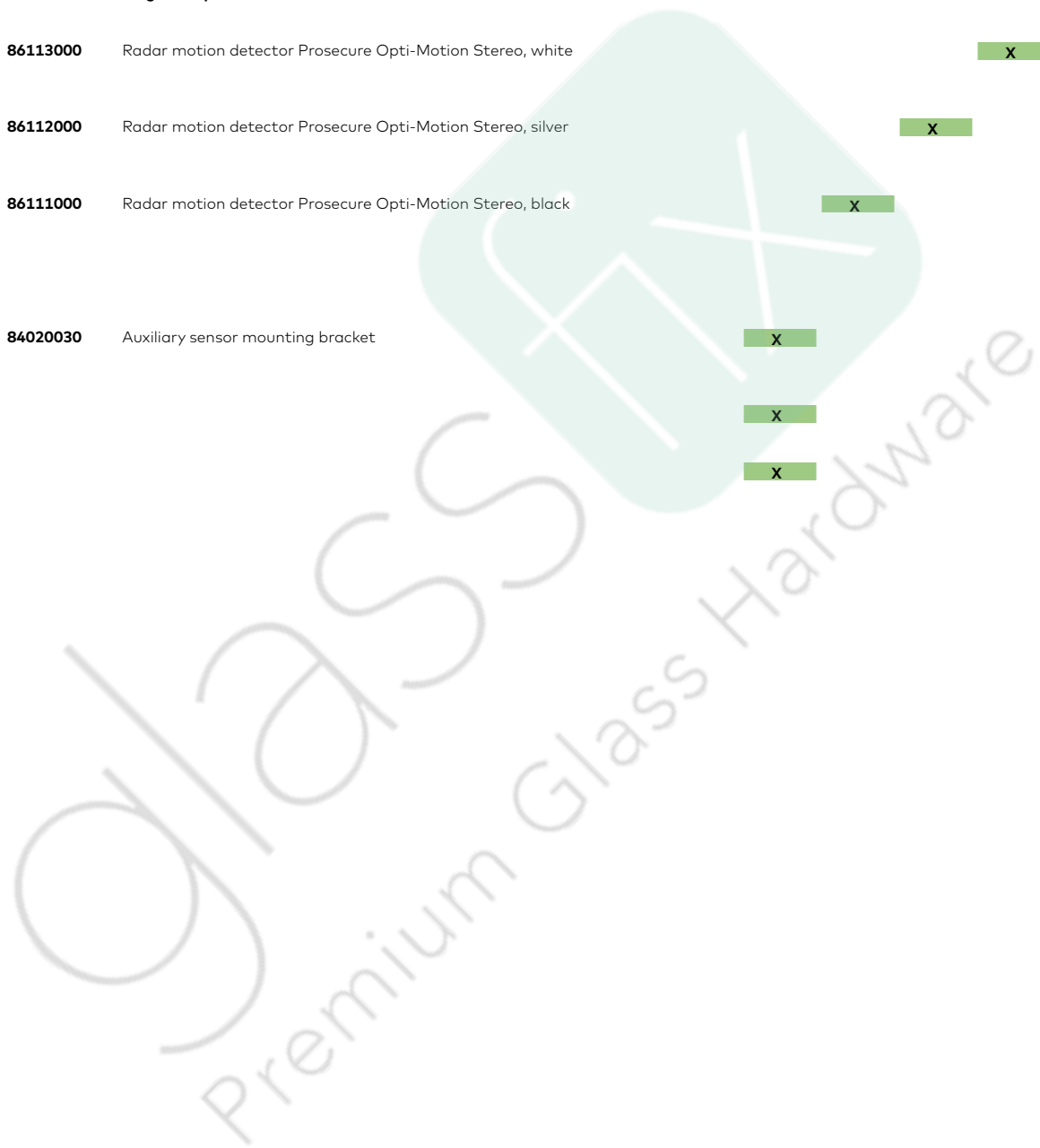

Single components

Art. No.	Description	Base parts (000)	AL mill finish (100)	AL silver EV1 anod (101) AL sim satin stainl steel anod (107)
		€/Piece	€/Piece	€/Piece
<b>Standard-length profiles for glass fixing system</b>				
34002798140	Mounting profile for glass fixing system		X	
34002799140	Mounting profile for glass fixing system, alu silver EV1			X
34002797140	Mounting profile for glass fixing system, alu sim. to satinised s/s			X
34002899140	Glass clamping rail for glass fixing system	X		
34002998140	Cover profile for glass fixing system		X	
34002999140	Cover profile for glass fixing system, alu silver EV1			X
34002997140	Cover profile for glass fixing system, alu sim. to satinised s/s			X
34003198140	Internal cover 62 mm		X	
34003199140	Internal cover 62 mm, alu silver EV1			X
34003197140	Internal cover 62 mm, alu sim. to satinised s/s			X
34003499140	Spacer profile, for glass fixing system	X		
34002599140	Operator profile, for glass fixing system	X		
34003098140	Internal cover 75 mm		X	
34003099140	Internal cover 75 mm, alu silver EV1			X
34003097140	Internal cover 75 mm, alu sim. to satinised s/s			X

Sliding

Single components

Sliding

Art. No.	Description	Base parts	AL	AL
		(000)	mill finish (100)	silver EV1 anod (101) AL sim satin stainl steel anod (107)
		€/Piece	€/Piece	€/Piece
<b>Profile in stock length 6250 mm</b>				
34002701120	Mounting profile for glass fixing system	X		
34002702120	Mounting profile for glass fixing system, alu silver EV1			X (101)
34002703120	Mounting profile for glass fixing system, alu sim. to satinised s/s			X (107)
34002801120	Glass clamping rail for glass fixing system	X		
34002901120	Cover profile for glass fixing system		X	
34002902120	Cover profile for glass fixing system, alu silver EV1			X (101)
34002903120	Cover profile for glass fixing system, alu sim. to satinised s/s			X (107)
34003103120	Internal cover 62 mm		X	
34003102120	Internal cover 62 mm, alu silver EV1			X (101)
34003104120	Internal cover 62 mm, alu sim. to satinised s/s			X (107)
34003003120	Spacer profile, for glass fixing system	X		
34003002120	Operator profile, for glass fixing system	X		
34003004120	Internal cover 75 mm		X	
34003401120	Internal cover 75 mm, alu silver EV1			X (101)
34002502120	Internal cover 75 mm, alu sim. to satinised s/s			X (107)

**The CS 80 MAGNEO system.**

Choose your system and required length based on your installation requirements:  
 The CS 80 MAGNEO operator door kit contains all the necessary components needed to complete the installation apart from the door leaf and activation devices.

- LV1** for driving paths F of up to 875 mm
- LV2** for driving paths F of up to 1,000 mm
- LV3** for driving paths F of up to 1,125 mm

**Driving path F = passage width DB + door panel projection AB**

DB =

A<sup>B</sup> =

F =

LV1  LV2  LV3

**Clear opening: on-wall mounting**

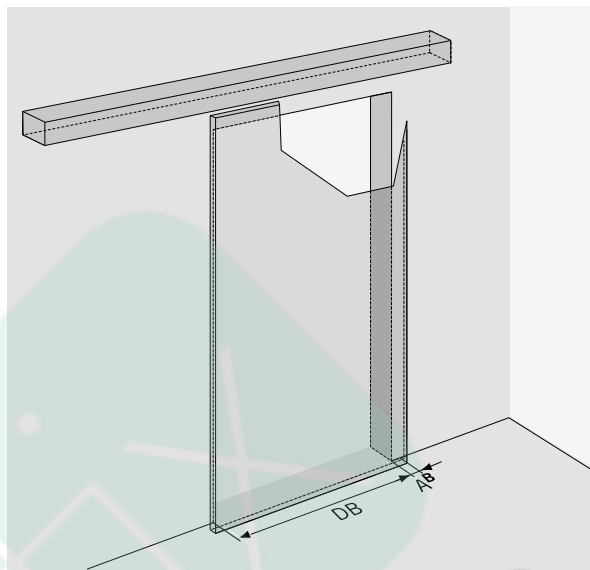

glass Premium Glass Hardware

Sliding

# STUDIO Rondo

Single action



Technical data	
Glass	TSG
Glass thickness	8, 10 mm
max. door weight	45 kg / 55 kg (OFFICE hinges)
Lock application	non-locking latch, profile cylinder, warded key, toilet lock, KABA cylinder
Applications	1-/2 panels, sidelight
Material	Aluminium, Brass
Finishes	Anodised- and RAL-Colors (coated), Brass
Specials	Tested acc. DIN 12209, Lock insert with „low-noise-whisper“ functionality, Adjustable lever handle follower (with the exception of „Non-locking latch, lever forward“)

## Manual single action door systems

### STUDIO

- 182 STUDIO Rondo
- 190 STUDIO Classic
- 196 STUDIO Gala 2.0
- 202 STUDIO Arcos
- 210 STUDIO Medio

### OFFICE

- 214 OFFICE Junior
- 220 OFFICE Classic
- 226 OFFICE Arcos

### 232 Special hinges

### 236 PORTEO

### ALEXA door frames

- 240 AT 23 / AT 23E
- 244 AT 44
- 250 AT 50 with AT 44 / AT 50 with MR 28
- 256 Order form

### General accessories for the single action door range

- 258 Frame pivots for internal doors
- 260 Frame pockets, push-on sleeves, strike plates
- 262 Door rails for internal doors
- 266 Floor bearings, profile cylinders, door bolts, door catches, floor sockets
- 270 Door closers, door closer accessories

### Example view for STUDIO Rondo

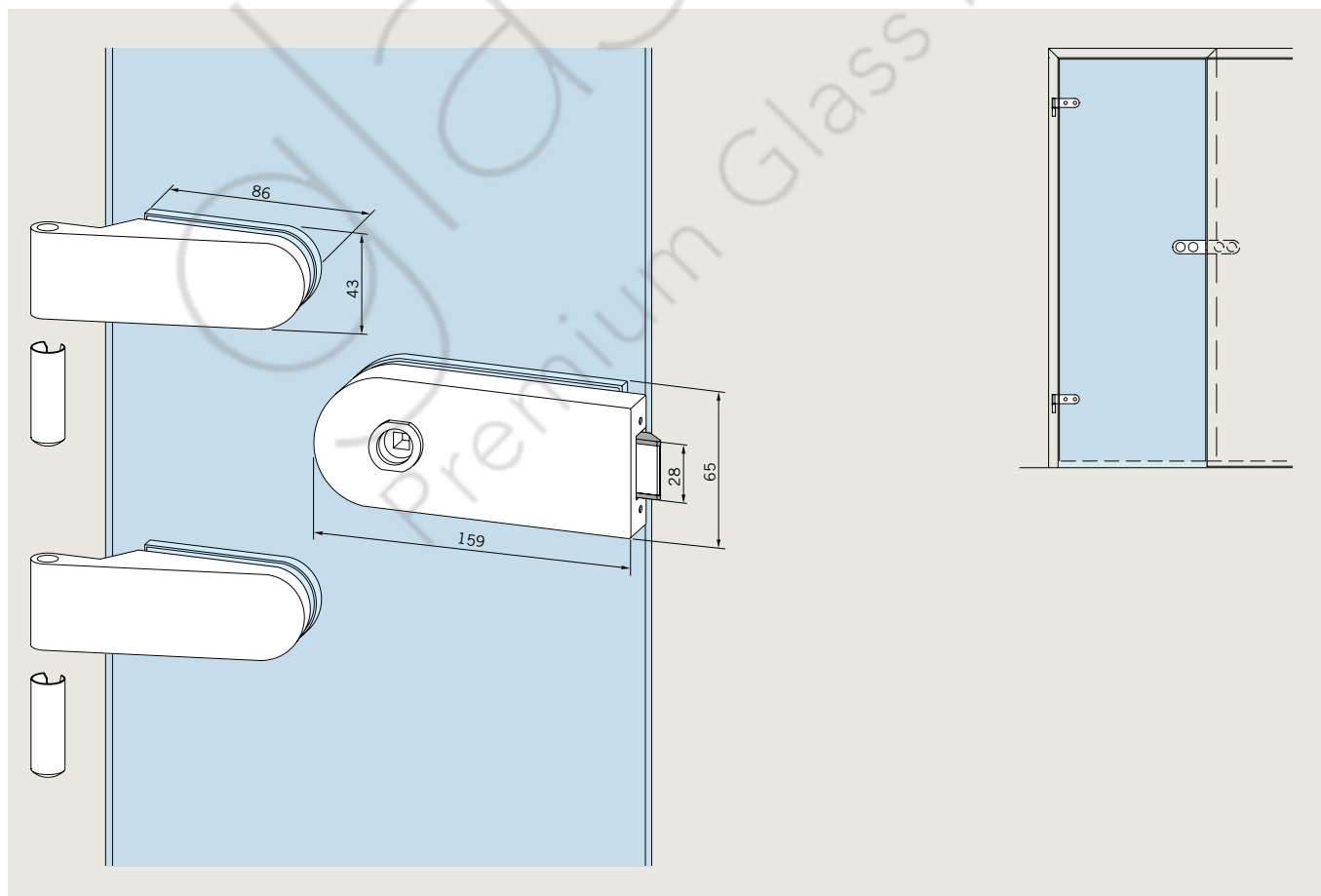

Complete sets

AL  
silver  
anod  
(150)

AL  
niro  
anod  
(157)

Art. No. Description €/Piece €/Piece

With follower  
for 8, 10 mm glass thickness (door weight 55 kg)

Single action

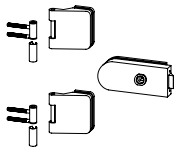

**51.739** **Combination:**  
**STUDIO Rondo Lock & OFFICE Classic hinges**  
STUDIO Rondo Lock non-locking latch, without lever,  
for lever forward, with follower for 8/10 mm glass thickness,  
incl. 2 OFFICE Junior hinges and sleeves,  
2 frame parts for timber frames

143,00 192,00

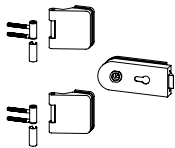

**51.740** **Combination:**  
**STUDIO Rondo Lock & OFFICE Classic hinges**  
STUDIO Rondo Lock profile cylinder, without lever,  
with follower for 8/10 mm glass thickness,  
incl. 2 OFFICE Junior hinges and sleeves,  
2 frame parts for timber frames

143,00 192,00

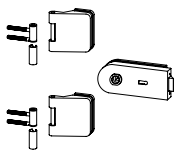

**51.741** **Combination:**  
**STUDIO Rondo Lock & OFFICE Junior hinges**  
STUDIO Rondo Lock warded key, without lever,  
with follower for 8/10 mm glass thickness,  
incl. 2 OFFICE Junior hinges and sleeves,  
2 frame parts for timber frames

143,00 192,00



Application of 10 mm glass thickness at 24 mm rebate  
depth possible (special latch on request)

Complying to the current DIN EN 12209.  
Separately and successfully tested with 200,000 latch  
and 200,000 locking bolt operating cycles..

All locks with low noise whisper functionality.  
Plus adjustable handle follower +1,5°-1°  
(with the exception of „Non-locking latch, lever forward“).



## Sets (locks, hinges and sleeves)

Art. No.	Description	AL silver anod (150)	AL traffic white p-coat (300)	AL brass-colored EV3 anod (105)	AL niro anod (157)	AL dark bronze DB 14 anod (108)	Brass polish chromed (501) Brass polish varnished (502)	AL special color anod (199)	AL special color p-coat (399)	
<b>With follower for 8 mm glass thickness</b>										
	10.100	Non-locking latch	120,00	120,00	144,00	173,00	144,00	300,00	217,00	217,00
	10.101	Non-locking latch, lever forward	120,00	120,00	144,00	173,00	144,00	300,00	217,00	217,00
	10.102	Prepared for profile cylinder	120,00	120,00	144,00	173,00	144,00	300,00	217,00	217,00
	10.108	Prepared for KABA cylinder	149,00			201,00			243,00	243,00
	10.103	Warded key	120,00	120,00	151,00	173,00	151,00	300,00	217,00	217,00
	10.106	Toilet lock	161,00	161,00	189,00	224,00	197,00	383,00	263,00	263,00
	10.120	Strike-box	127,00	127,00		183,00		304,00	227,00	227,00
<b>With follower for 10 mm glass thickness</b>										
	10.130	Non-locking latch	122,00			176,00	only (501) 303,00	220,00	220,00	
	10.131	Non-locking latch, lever forward	122,00			176,00	303,00	220,00	220,00	
	10.132	Prepared for profile cylinder	122,00			176,00	only (501) 303,00	220,00	220,00	
	10.129	Prepared for KABA cylinder	152,00					248,00	248,00	
	10.133	Warded key	122,00			176,00	only (501) 303,00	220,00	220,00	
	10.134	Toilet lock	163,00			227,00	only (501) 386,00	266,00	266,00	
	10.125	Strike-box	130,00			186,00	only (501) 308,00	230,00	230,00	

Application of 10 mm glass thickness at 24 mm rebate depth possible (special latch on request)

Complying to the current DIN EN 12209. Separately and successfully tested with 200,000 latch and 200,000 locking bolt operating cycles..

All locks with low noise whisper functionality. Plus adjustable handle follower +1,5°-1° (with the exception of „Non-locking latch, lever forward“).

Sets (locks, hinges and sleeves)

AL silver anod (150)    AL niro anod (157)    Brass polish chromed (501) Brass polish varnished (502)    AL special color anod (199)    AL special color p-coat (399)













Art. No.	Description	€/Piece	€/Piece	€/Piece	€/Piece	€/Piece	
<b>For levers with roses for 8 mm glass thickness</b>							
	10.110	Non-locking latch	142,00	203,00	only (501) 319,00	254,00	254,00
	10.111	Non-locking latch, lever forward	142,00	203,00	only (501) 319,00	254,00	254,00
	10.112	Prepared for profile cylinder	142,00	203,00	only (501) 319,00	254,00	254,00
	10.118	Prepared for KABA cylinder	169,00			281,00	281,00
	10.113	Warded key	142,00	203,00	only (501) 319,00	254,00	254,00
	10.120	Strike-box	127,00	183,00	304,00	227,00	227,00
<b>For levers with roses for 10 mm glass thickness</b>							
10.135	Non-locking latch	144,00	207,00		257,00	257,00	
10.136	Non-locking latch, lever forward	144,00	207,00		257,00	257,00	
10.137	Prepared for profile cylinder	144,00	207,00		257,00	257,00	
10.139	Prepared for KABA cylinder	172,00			283,00	283,00	
10.138	Warded key	144,00	207,00		257,00	257,00	
10.125	Strike-box	130,00	186,00		230,00	230,00	

Application of 10 mm glass thickness at 24 mm rebate depth possible (special latch on request)

Complying to the current DIN EN 12209. Separately and successfully tested with 200,000 latch and 200,000 locking bolt operating cycles..

All locks with low noise whisper functionality. Plus adjustable handle follower +1,5°-1° (with the exception of „Non-locking latch, lever forward“).

Single components

Art. No.	Description	AL silver anod (150)	AL traffic white p-coat (300)	AL brass-colored EV3 anod (105)	AL niro anod (157)	AL dark bronze DB 14 anod (108)	Brass polish chromed (501) Brass polish varnished (502)	AL special color anod (199)	AL special color p-coat (399)
<b>Locks with follower for 8 – 10 mm glass thickness</b>									
	10.200 Non-locking latch	83,50	83,50	101,00	118,00	101,00	172,00	152,00	152,00
	10.201 Non-locking latch, lever forward	83,50	83,50	101,00	118,00	101,00	172,00	152,00	152,00
	10.202 Prepared for profile cylinder	83,50	83,50	101,00	118,00	101,00	172,00	152,00	152,00
	10.203 Warded key	83,50	83,50	101,00	118,00	101,00	172,00	152,00	152,00
	10.207 Prepared for KABA cylinder	111,00			146,00			180,00	180,00
	10.206 Toilet lock	129,00	129,00		175,00		256,00	199,00	199,00
	10.220 Strike-box	91,00	91,00	109,00	128,00		176,00	163,00	163,00
<b>Locks for levers with roses for 8 – 10 mm glass thickness</b>									
	10.210 Non-locking latch	108,00	108,00		152,00		183,00	193,00	193,00
	10.211 Non-locking latch, lever forward	108,00	108,00		152,00		only (501) 183,00	193,00	193,00
	10.212 Prepared for profile cylinder	108,00	108,00		152,00		183,00	193,00	193,00
	10.213 Warded key	108,00	108,00		152,00		only (501) 183,00	193,00	193,00
	10.217 Prepared for KABA cylinder	136,00						222,00	222,00

Application of 10 mm glass thickness at 24 mm rebate depth possible (special latch on request)

All locks with low noise whisper functionality. Plus adjustable handle follower +1,5°-1° (with the exception of „Non-locking latch, lever forward“).



Single components

AL silver anod (150)	AL traffic white p-coat (300)	AL brass-colored EV3 anod (105)	AL niro anod (157)	AL dark bronze DB 14 anod (108)	Brass polish chromed (501)	Brass polish varnished (502)	AL special color anod (199)	AL special color p-coat (399)
----------------------	-------------------------------	---------------------------------	--------------------	---------------------------------	----------------------------	------------------------------	-----------------------------	-------------------------------

Single action

Art. No.	Description	€/Piece	€/Piece	€/Piece	€/Piece	€/Piece	€/Piece	€/Piece	€/Piece	€/Piece
<b>Door hinges for 8 mm glass thickness</b>										
	10.230 Rondo, incl. sleeve	25,00	25,00	30,00	33,50	30,00	81,00	81,00	43,50	43,50
	10.234 Door hinges with sleeve and filling piece for 40 mm rebate depth (Please indicate glass thickness)	36,50			51,50				63,00	63,00
	10.231 Hinge STUDIO Rondo with frame pivot for aluminium frames	42,00	42,00		75,50				75,50	75,50
	10.232 Hinge STUDIO Rondo with frame pivot for wooden frames	42,00	42,00	49,50	75,50	49,50			75,50	75,50
	10.235 Hinge STUDIO Rondo with frame pivot for wooden frames, strengthened version	55,00			97,50				97,50	97,50
	10.233 Door hinges for 28-30 mm rebate depth (Please indicate glass thickness and rebate depth)	49,50			69,50				81,00	81,00
	10.420 Filling piece with screws suitable for 10.230 for 31 - 39 mm rebate depth (Please indicate glass thickness and rebate depth)	26,00			35,50				38,00	38,00
	10.244 Hinge, glass to glass -LH	79,00			118,00				118,00	118,00
	10.246 do. -RH	79,00			118,00				118,00	118,00

## Single components

Art. No.	Description	AL	AL	AL	AL	Brass	AL	AL
		silver anod (150)	brass- colored EV3 anod (105)	niro anod (157)	dark bronze DB 14 anod (108)	polish chromed (501) Brass polish varnished (502)	special color anod (199)	special color p-coat (399)
		€/Piece	€/Piece	€/Piece	€/Piece	€/Piece	€/Piece	€/Piece
<b>Door hinges for 10 mm glass thickness</b>								
	<b>10.236</b> Rondo, incl. sleeve	26,00	34,50			82,00	45,50	45,50
	<b>10.237</b> Hinge STUDIO Rondo with frame pivot for aluminium frames	43,50	76,50				76,50	76,50
	<b>10.238</b> Hinge STUDIO Rondo with frame pivot for wooden frames	43,50	76,50				76,50	76,50
	<b>10.239</b> Hinge STUDIO Rondo with frame pivot for wooden frames, strengthened version	56,00	68,00	98,50			98,50	98,50
	<b>10.234</b> Door hinges with sleeve and filling piece for 40 mm rebate depth (Please indicate glass thickness)	36,50	51,50				63,00	63,00
	<b>10.233</b> Door hinges for 28 – 30 mm rebate depth (Please indicate glass thickness)	49,50	69,50				81,00	81,00
	<b>10.420</b> Filling piece with screws suitable for 10.230 for 31 – 39 mm rebate depth (Please indicate glass thickness)	26,00	35,50				38,00	38,00
	<b>10.245</b> Hinge, glass to glass fixing - LH	80,00	119,00				119,00	119,00
	<b>10.247</b> Hinge, glass to glass fixing -RH	80,00	119,00				119,00	119,00
<b>Frame parts</b>								
	<b>10.424</b> Frame pivot for wooden frames/STUDIO	(000) 5,00						

Further frame parts on pages 258 – 259

# STUDIO Classic

Single action



Technical data	
Glass	TSG
Glass thickness	8, 10 mm
max. door weight	45 kg / 55 kg (OFFICE hinges)
Lock application	non-locking latch, profile cylinder, warded key, toilet lock, KABA cylinder
Applications	1-/2 panels, sidelight
Material	Aluminium
Finishes	Anodised- and RAL-Colors (coated)
Specials	Tested acc. DIN 12209, Lock insert with „low-noise-whisper“ functionality, Adjustable lever handle follower (with the exception of „Non-locking latch, lever forward“)

## Manual single action door systems

### STUDIO

- 182 STUDIO Rondo
- 190 STUDIO Classic
- 196 STUDIO Gala 2.0
- 202 STUDIO Arcos
- 210 STUDIO Medio

### OFFICE

- 214 OFFICE Junior
- 220 OFFICE Classic
- 226 OFFICE Arcos

### 232 Special hinges

### 236 PORTEO

### ALEXA door frames

- 240 AT 23 / AT 23E
- 244 AT 44
- 250 AT 50 with AT 44 / AT 50 with MR 28
- 256 Order form

### General accessories for the single action door range

- 258 Frame pivots for internal doors
- 260 Frame pockets, push-on sleeves, strike plates
- 262 Door rails for internal doors
- 266 Floor bearings, profile cylinders, door bolts, door catches, floor sockets
- 270 Door closers, door closer accessories

### Example view for STUDIO Classic

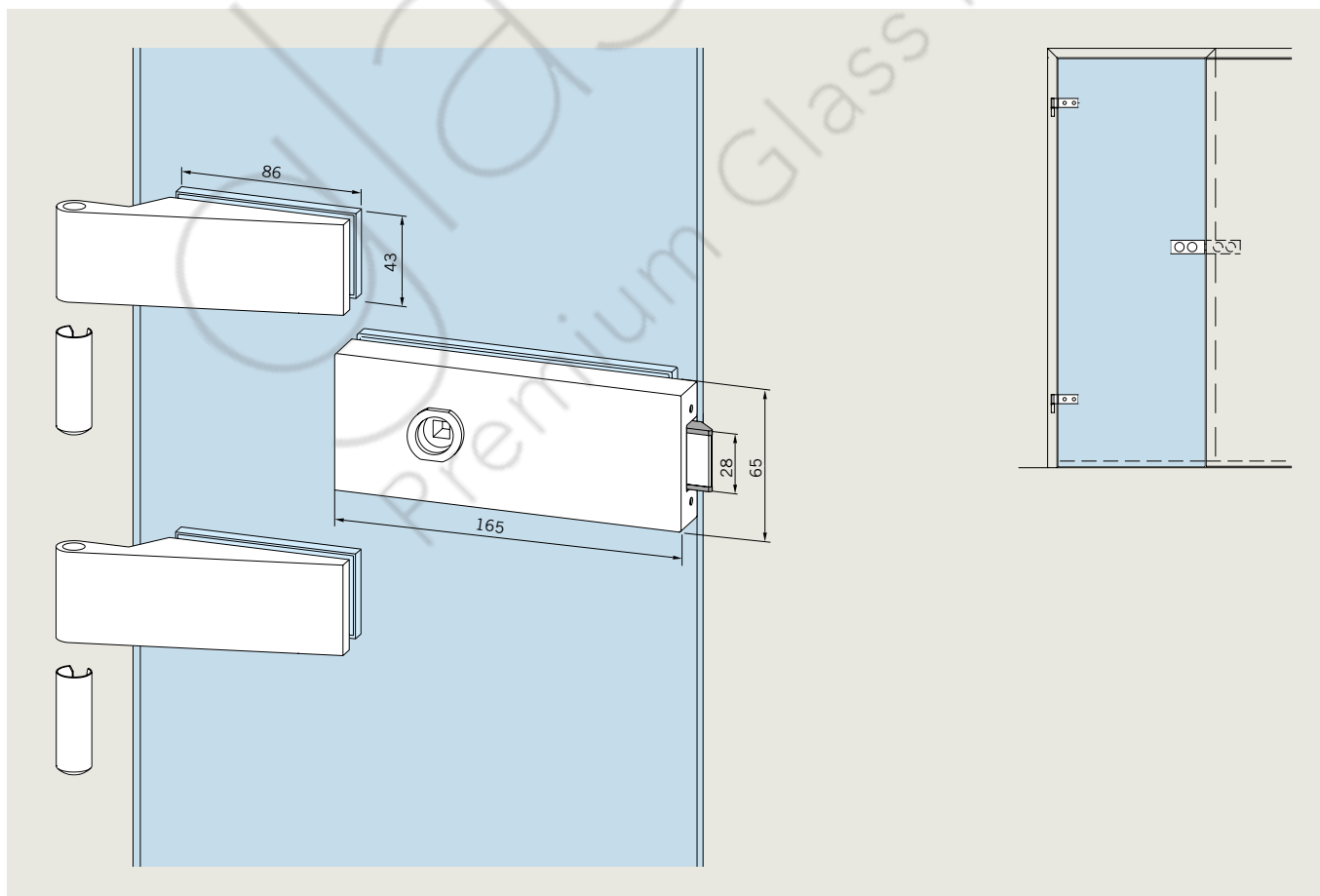

Complete sets

AL silver anod (150) AL niro anod (157)

Art. No. Description €/Piece €/Piece

Single action

With follower for 8, 10 mm glass thickness (door weight 55 kg)

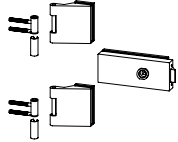

**51.746** **Combination: STUDIO Classic Lock & OFFICE Classic hinges**  
STUDIO Classic lock non-locking latch, without lever, for lever forward, with follower for 8/10 mm glass thickness, incl. 2 OFFICE Classic hinges and sleeves, 2 frame parts for timber frames

143,00 192,00

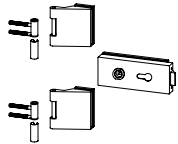

**51.747** **Combination: STUDIO Classic Lock & OFFICE Classic hinges**  
STUDIO Classic lock profile cylinder, without lever, with follower for 8/10 mm glass thickness, incl. 2 OFFICE Junior hinges and sleeves, 2 frame parts for timber frames

143,00 192,00

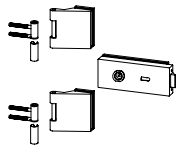

**51.748** **Combination: STUDIO Classic Lock & OFFICE Classic hinges**  
STUDIO Classic lock warded key, without lever, with follower for 8/10 mm glass thickness, incl. 2 OFFICE Classic hinges and sleeves, 2 frame parts for timber frames

143,00 192,00



Application of 10 mm glass thickness at 24 mm rebate depth possible (special latch on request)

Complying to the current DIN EN 12209. Separately and successfully tested with 200,000 latch and 200,000 locking bolt operating cycles..

All locks with low noise whisper functionality. Plus adjustable handle follower +1,5°-1° (with the exception of „Non-locking latch, lever forward“).



## Sets (locks, hinges and sleeves)

Art. No.	Description	AL silver anod (150)	AL niro anod (157)	AL special color anod (199)	AL special color p-coat (399)
<b>With follower for 8 mm glass thickness</b>					
	10.050 Non-locking latch	120,00	173,00	217,00	217,00
	10.051 Non-locking latch, lever forward	120,00	173,00	217,00	217,00
	10.052 Prepared for profile cylinder	120,00	173,00	217,00	217,00
	10.049 Prepared for KABA cylinder	149,00		243,00	243,00
	10.053 Warded key	120,00	173,00	217,00	217,00
	10.054 Toilet lock	161,00	224,00	263,00	263,00
	10.034 Strike-box	127,00	183,00	227,00	227,00
<b>With follower for 10 mm glass thickness</b>					
	10.055 Non-locking latch	122,00	176,00	220,00	220,00
	10.056 Non-locking latch, lever forward	122,00	176,00	220,00	220,00
	10.057 Prepared for profile cylinder	122,00	176,00	220,00	220,00
	10.060 Prepared for KABA cylinder	152,00		248,00	248,00
	10.058 Warded key	122,00	176,00	220,00	220,00
	10.059 Toilet lock	163,00	227,00	266,00	266,00
	10.039 Strike-box	130,00	186,00	230,00	230,00
<b>For levers with roses, for 8 mm glass thickness</b>					
	10.030 Non-locking latch	142,00	203,00	254,00	254,00
	10.031 Non-locking latch, lever forward	142,00	203,00	254,00	254,00
	10.032 Prepared for profile cylinder	142,00	203,00	254,00	254,00
	10.028 Prepared for KABA cylinder	169,00		281,00	281,00
	10.033 Warded key	142,00	203,00	254,00	254,00
	10.034 Strike-box	127,00	183,00	227,00	227,00

**Application of 10 mm glass thickness at 24 mm rebate depth possible (special latch on request)**

Complying to the current DIN EN 12209.  
Separately and successfully tested with 200,000 latch and 200,000 locking bolt operating cycles..

All locks with low noise whisper functionality.  
Plus adjustable handle follower +1,5°-1°  
(with the exception of „Non-locking latch, lever forward“).

Sets (locks, hinges and sleeves) and single components

AL silver anod (150) AL traffic white p-coat (300) AL niro anod (157) AL special color anod (199) AL special color p-coat (399)

Art. No. Description €/Piece €/Piece €/Piece €/Piece €/Piece

For levers with roses, for 10 mm glass thickness

10.035	Non-locking latch	144,00	207,00	257,00	257,00
10.036	Non-locking latch, lever forward	144,00	207,00	257,00	257,00
10.037	Prepared for profile cylinder	144,00	207,00	257,00	257,00
10.029	Prepared for KABA cylinder	172,00		283,00	283,00
10.038	Warded key	144,00	207,00	257,00	257,00
10.039	Strike-box	130,00	186,00	230,00	230,00

Single components

Locks with follower for 8 – 10 mm glass thickness



10.001	Non-locking latch	83,50	83,50	118,00	152,00	152,00
10.002	Non-locking latch, lever forward	83,50	83,50	118,00	152,00	152,00
10.003	Prepared for profile cylinder	83,50	83,50	118,00	152,00	152,00
10.007	Prepared for KABA cylinder	111,00		146,00	180,00	180,00
10.004	Warded key	83,50	83,50	118,00	152,00	152,00
10.006	Toilet lock	129,00		175,00	199,00	199,00
10.005	Strike-box	91,00	91,00	128,00	163,00	163,00
10.512	Strike-box short	65,00		81,50	106,00	106,00



Application of 10 mm glass thickness at 24 mm rebate depth possible (special latch on request)

Complying to the current DIN EN 12209. Separately and successfully tested with 200,000 latch and 200,000 locking bolt operating cycles..

All locks with low noise whisper functionality. Plus adjustable handle follower +1,5°-1° (with the exception of „Non-locking latch, lever forward“).

Single action

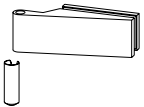
## Single components

Art. No.	Description	AL silver anod (150)	AL traffic white p-coat (300)	AL niro anod (157)	AL dark bronze DB 14 anod (108)	AL special color anod (199)	AL special color p-coat (399)
		€/Piece	€/Piece	€/Piece	€/Piece	€/Piece	€/Piece
<b>Locks for levers with roses for 8 – 10 mm glass thickness</b>							
10.040	Non-locking latch	108,00	152,00	193,00	193,00		
10.041	Non-locking latch, lever forward	108,00	152,00	193,00	193,00		
10.042	Prepared for profile cylinder	108,00	152,00	193,00	193,00		
10.044	Prepared for KABA cylinder	136,00		222,00	222,00		
10.043	Warded key	108,00	152,00	193,00	193,00		
<b>Door hinges for 8 mm glass thickness</b>							
 10.021	Classic, incl. sleeve	25,00	25,00	33,50	30,00	43,50	43,50
<b>Door hinges for 10 mm glass thickness</b>							
 10.020	Classic, incl. sleeve	26,00	34,50	45,50	45,50		
<b>Frame parts</b>							
 10.424	Frame pivot for wooden frames/Studio	(000) 5,00					

Further frame parts on pages 258 – 259

**Application of 10 mm glass thickness at 24 mm rebate depth possible (special latch on request)**

Complying to the current DIN EN 12209.  
Separately and successfully tested with 200,000 latch and 200,000 locking bolt operating cycles..

All locks with low noise whisper functionality.  
Plus adjustable handle follower +1,5°/-1°  
(with the exception of „Non-locking latch, lever forward“).

# STUDIO Gala 2.0

Single action



Technical data	
Glass	TSG
Glass thickness	8, 10 mm
max. door weight	45 kg / 55 kg (OFFICE hinges)
Lock application	non-locking latch, profile cylinder, warded key,
Applications	1-panel
Material	Aluminium
Finishes	Anodised- and RAL-Colors, Brass
Specials	Tested acc. DIN 12209, Lock insert with „low-noise-whisper“ functionality, Adjustable lever handle follower

## Manual single action door systems

### STUDIO

- 182 STUDIO Rondo
- 190 STUDIO Classic
- 196 STUDIO Gala 2.0
- 202 STUDIO Arcos
- 210 STUDIO Medio

### OFFICE

- 214 OFFICE Junior
- 220 OFFICE Classic
- 226 OFFICE Arcos

### 232 Special hinges

### 236 PORTEO

### ALEXA door frames

- 240 AT 23 / AT 23E
- 244 AT 44
- 250 AT 50 with AT 44 / AT 50 with MR 28
- 256 Order form

### General accessories for the single action door range

- 258 Frame pivots for internal doors
- 260 Frame pockets, push-on sleeves, strike plates
- 262 Door rails for internal doors
- 266 Floor bearings, profile cylinders, door bolts, door catches, floor sockets
- 270 Door closers, door closer accessories

### Example view for STUDIO Gala 2.0

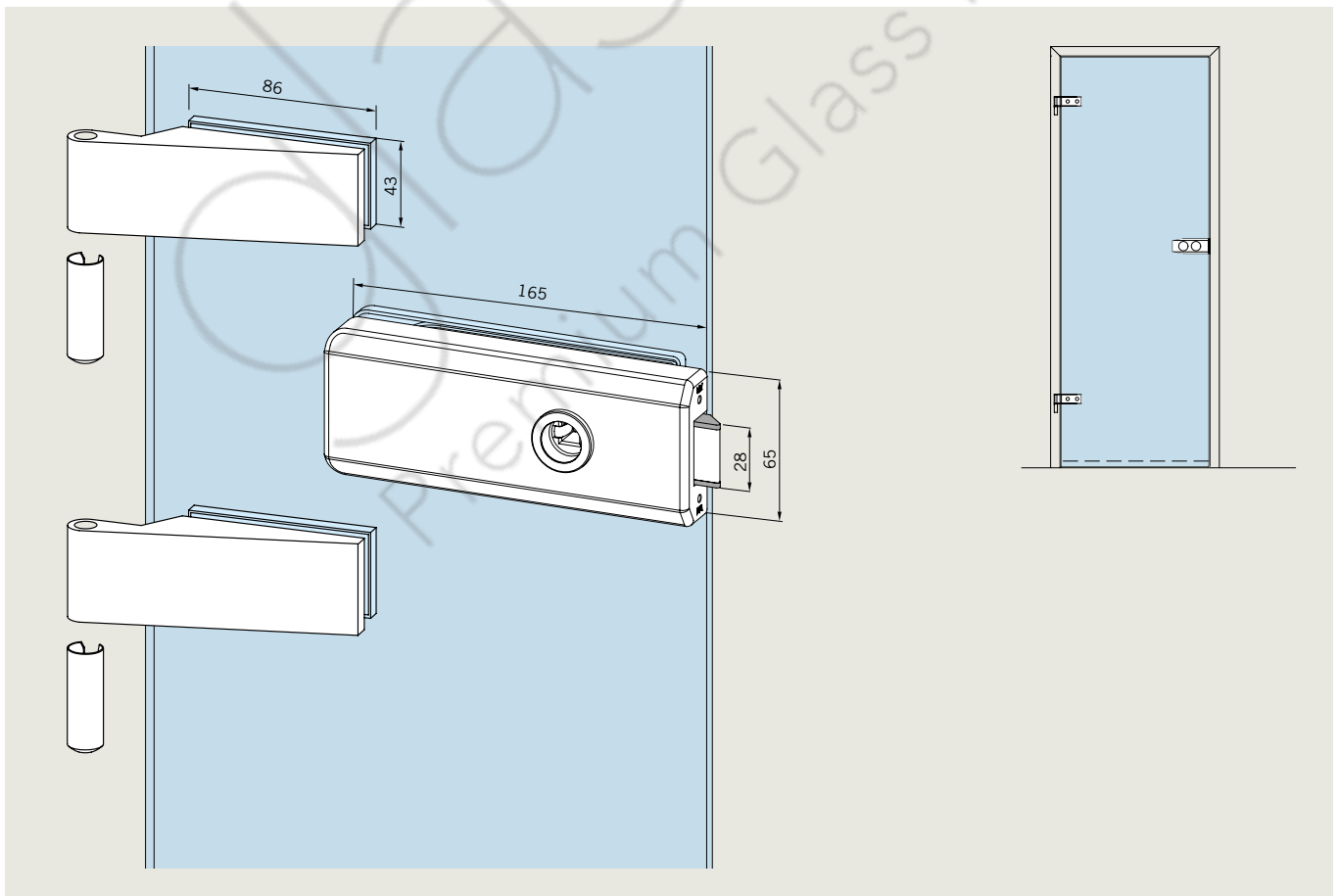

Complete sets

AL  
silver  
anod  
(150)

AL  
niro  
anod  
(157)

Art. No. Description €/Piece €/Piece

With follower,  
for 8, 10 mm glass thickness (door weight 55 kg)



**55.726** **Combination:**  
**STUDIO Gala 2.0 lock & OFFICE Classic hinges**  
STUDIO Gala 2.0 lock non-locking latch, without lever,  
for lever forward, with follower for 8/10 mm glass thickness  
incl. 2 OFFICE Classic hinges and sleeves,  
2 frame parts for timber frames

143,00 192,00



**55.727** **Combination:**  
**STUDIO Gala 2.0 lock & OFFICE Classic hinges**  
STUDIO Gala 2.0 lock profile cylinder, without lever,  
with follower for 8/10 mm glass thickness  
incl. 2 OFFICE Classic hinges and sleeves,  
2 frame parts for timber frames

143,00 192,00



**55.728** **Combination:**  
**STUDIO Gala 2.0 lock & OFFICE Classic hinges**  
STUDIO Gala 2.0 lock warded key, without lever,  
with follower for 8/10 mm glass thickness  
incl. 2 OFFICE Classic hinges and sleeves,  
2 frame parts for timber frames

143,00 192,00

Application of 10 mm glass thickness at 24 mm rebate  
depth possible (special latch on request)

Complying to the current DIN EN 12209.  
Separately and successfully tested with 200,000 latch  
and 200,000 locking bolt operating cycles..









All locks with low noise whisper functionality.  
Plus adjustable handle follower +1,5°-1°  
(with the exception of „Non-locking latch, lever forward“).

Single action



## Sets (locks, hinges and sleeves)

AL silver anod (150)	AL niro anod (157)	AL white p-coat (350)
-------------------------------	-----------------------------	--------------------------------

Art. No.	Description	€/Piece	€/Piece	€/Piece
<b>STUDIO Gala 2.0 locks and OFFICE Classic hinges</b>				
	<b>19.630</b> STUDIO Gala 2.0 Non-locking latch, with OFFICE Classic Hinges	120,00	173,00	120,00
	<b>19.631</b> STUDIO Gala 2.0 non-locking latch, lever forward*, with OFFICE Classic Hinges	120,00	173,00	120,00
	<b>19.632</b> STUDIO Gala 2.0 prepared for profile cylinder, with OFFICE Classic Hinges	120,00	173,00	120,00
	<b>19.633</b> STUDIO Gala 2.0 warded key, with OFFICE Classic Hinges	120,00	173,00	120,00
<b>STUDIO Gala 2.0 locks and STUDIO Classic hinges</b>				
	<b>19.620</b> STUDIO Gala 2.0 Schloss Non-locking latch, with STUDIO Classic hinges	120,00	173,00	120,00
	<b>19.621</b> STUDIO Gala 2.0 non-locking latch, lever forward, with STUDIO Classic hinges	120,00	173,00	120,00
	<b>19.622</b> STUDIO Gala 2.0 prepared for profile cylinder, with STUDIO Classic hinges	120,00	173,00	120,00
	<b>19.623</b> STUDIO Gala 2.0 warded key, with STUDIO Classic hinges	120,00	173,00	120,00

**Application of 10 mm glass thickness at 24 mm rebate depth possible (special latch on request)**









Complying to the current DIN EN 12209.  
Separately and successfully tested with 200,000 latch and 200,000 locking bolt operating cycles..

All locks with low noise whisper functionality.  
Plus adjustable handle follower +1,5°/-1°  
(with the exception of „Non-locking latch, lever forward“).

Single components

Base parts (000) AL silver anod (150) AL niro anod (157) AL white p-coat (350)

Single action

Art. No.	Description	€/Piece	€/Piece	€/Piece	€/Piece
<b>Locks with follower</b>					
	<b>19.610</b> Non-locking latch	83,50	118,00	83,50	83,50
	<b>19.611</b> Non-locking latch, lever forward*	83,50	118,00	83,50	83,50
	<b>19.612</b> Prepared for profile cylinder	83,50	118,00	83,50	83,50
	<b>19.613</b> Warded key	83,50	118,00	83,50	83,50
<b>Türbänder</b>					
	<b>11.288</b> Aluminium door hinge with sleeve	25,50	33,00	25,50	25,50
	<b>10.021</b> Classic, with sleeve	25,00	33,50	25,00	25,00
<b>Frame pivots</b>					
	<b>11.310</b> Frame pivot for wooden frames / Office	5,10			
	<b>10.424</b> Frame pivot for wooden frames / STUDIO	5,10			

Further frame parts on pages 258 – 259

**Application of 10 mm glass thickness at 24 mm rebate depth possible (special latch on request)**

Complying to the current DIN EN 12209. Separately and successfully tested with 200,000 latch and 200,000 locking bolt operating cycles..

All locks with low noise whisper functionality. Plus adjustable handle follower +1,5°-1° (with the exception of „Non-locking latch, lever forward“).



**Notes**



Single action

# STUDIO Arcos

Single action



reddot design award



Technical data	
Glass	TSG
Glass thickness	8, 10 mm
max. door weight	45 kg / 55 kg (OFFICE hinges)
Lock application	non-locking latch, profile cylinder, warded key, toilet lock, KABA cylinder
Applications	1-/2 panels, sidelight
Material	Aluminium, brass
Finishes	Anodised- and RAL-Colors (coated), brass
Specials	Tested acc. DIN 12209, Lock insert with „low-noise-whisper“ functionality, Adjustable lever handle follower (with the exception of „Non-locking latch, lever forward“)

## Manual single action door systems

### STUDIO

- 182 STUDIO Rondo
- 190 STUDIO Classic
- 196 STUDIO Gala 2.0
- 202 STUDIO Arcos
- 210 STUDIO Medio

### OFFICE

- 214 OFFICE Junior
- 220 OFFICE Classic
- 226 OFFICE Arcos

### 232 Special hinges

### 236 PORTEO

### ALEXA door frames

- 240 AT 23 / AT 23E
- 244 AT 44
- 250 AT 50 with AT 44 / AT 50 with MR 28
- 256 Order form

### General accessories for the single action door range

- 258 Frame pivots for internal doors
- 260 Frame pockets, push-on sleeves, strike plates
- 262 Door rails for internal doors
- 266 Floor bearings, profile cylinders, door bolts, door catches, floor sockets
- 270 Door closers, door closer accessories

### Example view for STUDIO Arcos

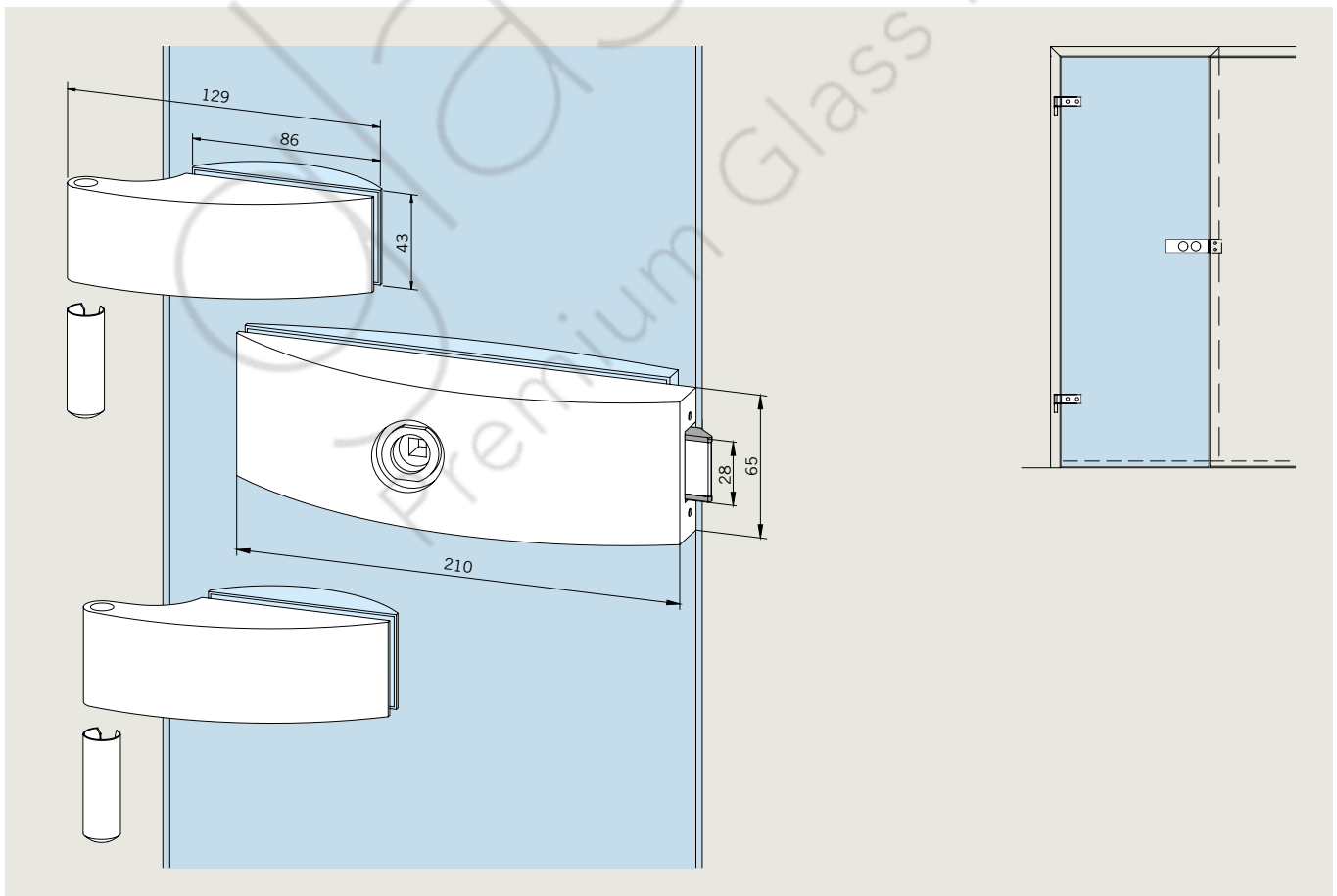

Complete sets

AL EV1-Deco  
anod (114)

AL niro  
anod (157)

Art. No. Description €/Piece €/Piece

With follower,  
for 8, 10 mm glass thickness (door weight 55 kg)

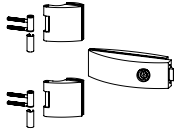

**51.718** **Combination:**  
**STUDIO Arcos & OFFICE Arcos hinges**  
STUDIO Classic lock non-locking latch, without lever, lever forward,  
with follower for 8/10 mm glass thickness,  
incl. 2 OFFICE Arcos hinges and sleeves,  
2 frame parts for timber frames

154,00 209,00

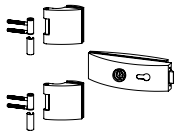

**51.719** **Combination:**  
**STUDIO Arcos & OFFICE Arcos hinges**  
STUDIO Classic lock profile cylinder, without lever,  
with follower for 8/10 mm glass thickness,  
incl. 2 OFFICE Arcos hinges and sleeves,  
2 frame parts for timber frames

154,00 209,00

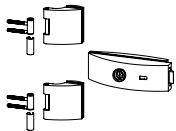

**51.720** **Combination:**  
**STUDIO Arcos & OFFICE Arcos hinges**  
STUDIO Classic lock warded key, without lever,  
with follower for 8/10 mm glass thickness,  
incl. 2 OFFICE Arcos hinges and sleeves,  
2 frame parts for timber frames





154,00 209,00

Application of 10 mm glass thickness at 24 mm rebate  
depth possible (special latch on request)

Complying to the current DIN EN 12209.  
Separately and successfully tested with 200,000 latch  
and 200,000 locking bolt operating cycles..

All locks with low noise whisper functionality.  
Plus adjustable handle follower +1,5°-1°  
(with the exception of „Non-locking latch, lever forward“).

## Complete sets (locks, hinges and sleeves)

Art. No.	Description	AL EV1-Deco anod (114)	AL traffic white p-coat (300)	AL niro anod (157)	Brass polish chromed (501) Brass polish varnished (502)	AL special color anod (199)	AL special color p-coat (399)
		€/Piece	€/Piece	€/Piece	€/Piece	€/Piece	€/Piece
<b>With follower for 8 mm glass thickness</b>							
	24.100 Non-locking latch	134,00	134,00	194,00	335,00	240,00	240,00
	24.101 Non-locking latch, lever forward	134,00	134,00	194,00	335,00	240,00	240,00
	24.102 Prepared for profile cylinder	134,00	134,00	194,00	335,00	240,00	240,00
	24.108 Prepared for KABA cylinder	161,00		222,00		268,00	268,00
	24.103 Warded key	134,00	134,00	194,00	335,00	240,00	240,00
	24.106 Toilet lock	180,00	180,00	250,00	428,00	294,00	294,00
	24.120 Strike-box	122,00	122,00	180,00	only (501) 317,00	222,00	222,00
<b>With follower for 10 mm glass thickness</b>							
	24.130 Non-locking latch	138,00		197,00	only (501) 337,00	243,00	243,00
	24.131 Non-locking latch, lever forward	138,00		197,00	only (501) 337,00	243,00	243,00
	24.132 Prepared for profile cylinder	138,00		197,00	only (501) 337,00	243,00	243,00
	24.129 Prepared for KABA cylinder	165,00		224,00		270,00	270,00
	24.133 Warded key	138,00		197,00	only (501) 337,00	243,00	243,00
	24.134 Toilet lock	182,00		253,00	only (501) 430,00	297,00	297,00
	24.125 Strike-box	127,00		182,00	only (501) 319,00	224,00	224,00

**Application of 10 mm glass thickness at 24 mm rebate  
depth possible (special latch on request)**

Complying to the current DIN EN 12209.  
Separately and successfully tested with 200,000 latch  
and 200,000 locking bolt operating cycles..

All locks with low noise whisper functionality.  
Plus adjustable handle follower +1,5°/-1°  
(with the exception of „Non-locking latch, lever forward“).

Complete sets (locks, hinges and sleeves)

AL EV1-Deco anod (114)    AL traffic white p-coat (300)    AL niro anod (157)    Brass polish chromed (501)    AL special color anod (199)    AL special color p-coat (399)

Single action

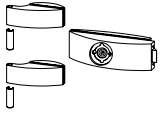
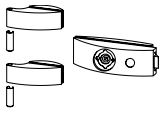
Art. No.	Description	€/Piece	€/Piece	€/Piece	€/Piece	€/Piece	€/Piece
<b>For levers with roses for 8 mm glass thickness</b>							
	<b>24.110</b> Non-locking latch	158,00	158,00	229,00		282,00	282,00
	<b>24.111</b> Non-locking latch, lever forward	158,00	158,00	229,00		282,00	282,00
	<b>24.112</b> Prepared for profile cylinder	158,00	158,00	229,00		282,00	282,00
	<b>24.118</b> Prepared for KABA cylinder	185,00		257,00		313,00	313,00
	<b>24.113</b> Warded key	158,00	158,00	229,00		282,00	282,00
	<b>24.120</b> Strike-box	122,00	122,00	180,00	317,00	222,00	222,00
<b>For levers with roses for 10 mm glass thickness</b>							
	<b>24.135</b> Non-locking latch	160,00		231,00		286,00	286,00
	<b>24.136</b> Non-locking latch, lever forward	160,00		231,00		286,00	286,00
	<b>24.137</b> Prepared for profile cylinder	160,00		231,00		286,00	286,00
	<b>24.139</b> Prepared for KABA cylinder	187,00		259,00		316,00	316,00
	<b>24.138</b> Warded key	160,00		230,00		286,00	286,00
	<b>24.125</b> Strike-box	127,00		180,00	319,00	224,00	224,00

Application of 10 mm glass thickness at 24 mm rebate depth possible (special latch on request)

Complying to the current DIN EN 12209. Separately and successfully tested with 200,000 latch and 200,000 locking bolt operating cycles..

All locks with low noise whisper functionality. Plus adjustable handle follower +1,5°-1° (with the exception of „Non-locking latch, lever forward“).

## Single components

Art. No.	Description	AL EV1-Deco anod (114)	AL traffic white p-coat (300)	AL niro anod (157)	Brass polish chromed (501) Brass polish varnished (502)	AL special color anod (199)	AL special color p-coat (399)
		€/Piece	€/Piece	€/Piece	€/Piece	€/Piece	€/Piece
<b>Locks with follower for 8 – 10 mm glass thickness</b>							
	<b>24.200</b> Non-locking latch	94,50	94,50	131,00	192,00	168,00	168,00
	<b>24.201</b> Non-locking latch, lever forward	94,50	94,50	131,00	192,00	168,00	168,00
	<b>24.202</b> Prepared for profile cylinder	94,50	94,50	131,00	192,00	168,00	168,00
	<b>24.207</b> Prepared for KABA cylinder	121,00		159,00		196,00	196,00
	<b>24.203</b> Warded key	94,50		131,00	192,00	168,00	168,00
	<b>24.206</b> Toilet lock	144,00	144,00	196,00	282,00	222,00	222,00
	<b>24.220</b> Strike-box	82,00	82,00	116,00	168,00	149,00	149,00
<b>Locks for levers with roses for 8 – 10 mm glass thickness</b>							
	<b>24.210</b> Non-locking latch	120,00		168,00		218,00	218,00
	<b>24.211</b> Non-locking latch, lever forward	120,00		168,00		218,00	218,00
	<b>24.212</b> Prepared for profile cylinder	120,00	120,00	168,00		218,00	218,00
	<b>24.217</b> Prepared for KABA cylinder	149,00		196,00		243,00	243,00
	<b>24.213</b> Warded key	120,00		168,00		218,00	218,00









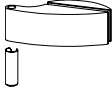

**Application of 10 mm glass thickness at 24 mm rebate depth possible (special latch on request)**

Complying to the current DIN EN 12209.  
Separately and successfully tested with 200,000 latch and 200,000 locking bolt operating cycles..

All locks with low noise whisper functionality.  
Plus adjustable handle follower +1,5°/-1°  
(with the exception of „Non-locking latch, lever forward“).

Single components

Single action

Art. No.	Description	Base parts (000)	AL EV1-Deco anod (114)	AL traffic white p-coat (300)	AL silver brilliant anod (103)	AL niro anod (157)	Brass polish chromed (501) Brass polish varnished (502)	AL special color anod (199)	AL special color p-coat (399)	
		€/Piece	€/Piece	€/Piece	€/Piece	€/Piece	€/Piece	€/Piece	€/Piece	
<b>Door hinges for 8 mm glass thickness</b>										
	<b>24.230</b> Arcos hinge, incl. sleeve		27,00	27,00	31,00	38,00	90,00	48,50	48,50	
	<b>25.450</b> Arcos hinge with frame pivot (from 01.05.18: <b>25.451</b> )		50,50	50,50		69,00		85,50	85,50	
<b>Door hinges for 10 mm glass thickness</b>										
	<b>24.236</b> Arcos hinge, incl. sleeve		29,00	29,00		39,00		49,50	49,50	
	<b>24.420</b> Filling piece with screws to use with 24.230 for 28 – 40 mm rebate depth (please indicate glass thickness and rebate depth)		29,00		34,50	40,00		42,00	42,00	
<b>Special hinges</b>										
	<b>25.401</b> Pair of ARCOS corner hinges for 8 mm glass thickness		54,50		68,50	81,00		83,00	83,00	
	<b>25.409</b> Pair of ARCOS corner hinges for 10 mm glass thickness		57,50		70,00	83,00		86,00	86,00	
	<b>12.016</b> Pair of floor/ceiling pivot bearing For 12.001 and 12.009		18,50							
	<b>12.014</b> Piece of floor/ceiling pivot bearing bottom left/ top right		10,00							
	<b>12.015</b> Piece of floor/ceiling pivot bearing bottom right/ top left		10,00							
	<b>12.003</b> Frame fixed pivot		10,00							
	<b>12.004</b> Screw-in pivot		8,90							
<b>Frame parts</b>										
	<b>10.424</b> Frame pivot for wooden frames/ STUDIO		5,00							
	<b>10.423</b> Frame pivot for steel frames/ STUDIO		3,70							
	Further frame parts on pages 258 – 259									



**Notes**



Single action

# STUDIO Medio

Single action



Technical data	
Glass	TSG
Glass thickness	8, 10 mm
max. door weight	depends on door hinge
Lock application	non-locking latch
Applications	1-/2 panels, sidelight
Material	Aluminium
Finishes	Anodised- and RAL-Colors (coated)
Specials	minimal measures

## Manual single action door systems

### STUDIO

- 182 STUDIO Rondo
- 190 STUDIO Classic
- 196 STUDIO Gala 2.0
- 202 STUDIO Arcos
- 210 STUDIO Medio

### OFFICE

- 214 OFFICE Junior
- 220 OFFICE Classic
- 226 OFFICE Arcos

### 232 Special hinges

### 236 PORTEO

### ALEXA door frames

- 240 AT 23 / AT 23E
- 244 AT 44
- 250 AT 50 with AT 44 / AT 50 with MR 28
- 256 Order form

### General accessories for the single action door range

- 258 Frame pivots for internal doors
- 260 Frame pockets, push-on sleeves, strike plates
- 262 Door rails for internal doors
- 266 Floor bearings, profile cylinders, door bolts, door catches, floor sockets
- 270 Door closers, door closer accessories

### Example view for STUDIO Medio

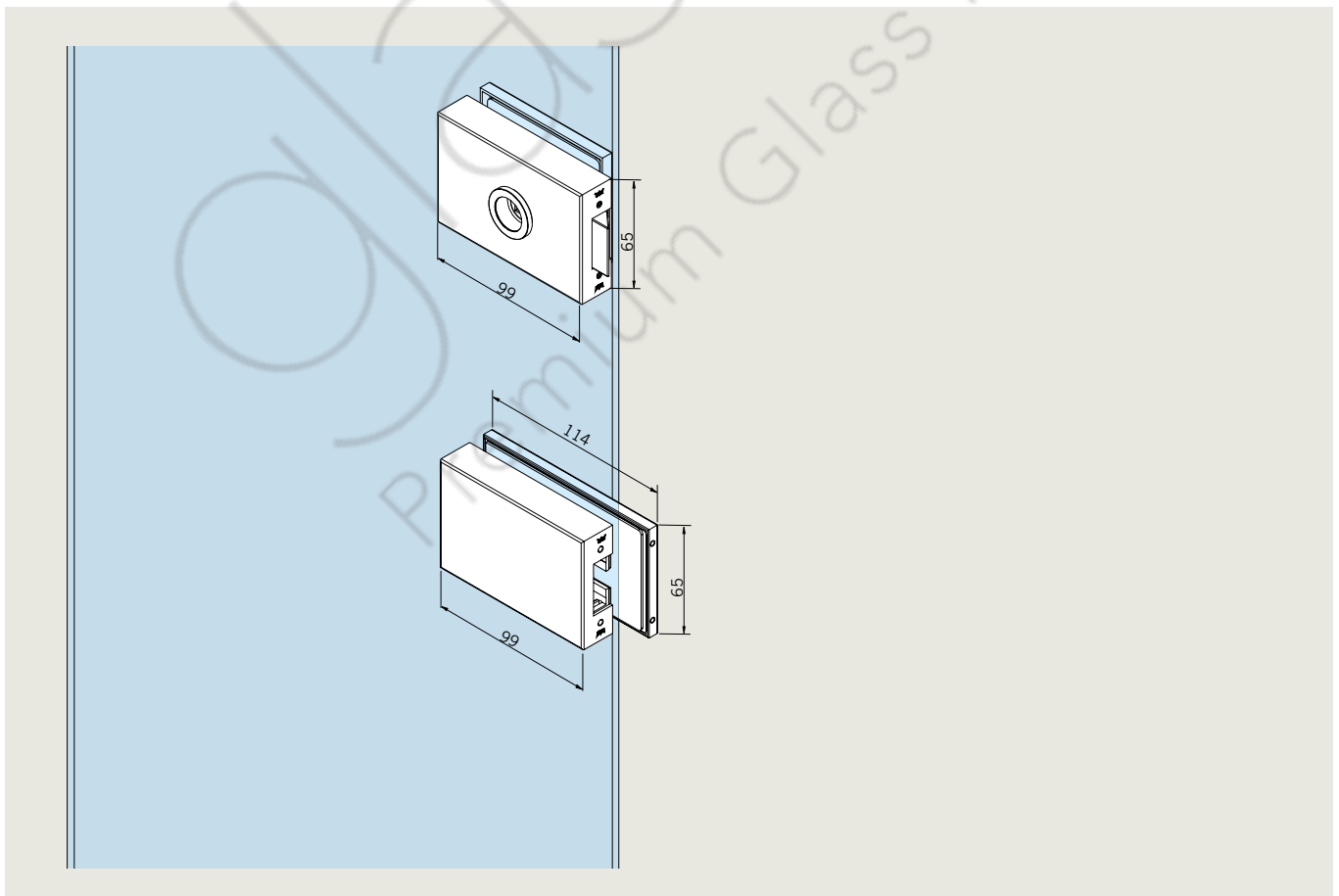

Complete sets and single components

AL EV1-Deco anod (114)	AL niro anod (157)	AL special color anod (199)	AL special color p-coat (399)
---------------------------------	-----------------------------	---	---

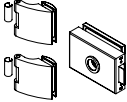
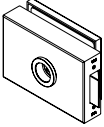
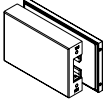
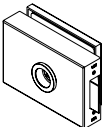
Art. No.	Description	€/Piece	€/Piece	€/Piece	€/Piece
	<b>10.511</b> <b>Combination:</b> <b>STUDIO Medio lock &amp; OFFICE Arcos hinges</b> STUDIO Medio lock non-locking latch, without lever, for lever forward, with follower for 8 mm Glass thickness, incl. 2 OFFICE Arcos hinges and sleeves		<b>134,00</b>		
	<b>Single components</b>				
	<b>STUDIO Medio lock with follower for 8 mm glass thickness</b>				
	<b>10.510</b> Non-locking latch	64,00	73,00	94,00	94,00
	<b>10.512</b> Strike-box	74,00	81,50	106,00	106,00
	<b>STUDIO Medio lock with follower for 10 mm glass thickness (in door frame with 24 mm rebate depth)</b>				
	<b>10.509</b> Non-locking, milled latch	65,00	74,50		

Single action

**Notes**



Single action

# OFFICE Junior

Single action



Technical data	
Glass	TSG
Glass thickness	8, 10 , 12 mm (please indicate with your order)
max. door weight	55 kg
Lock application	non-locking latch, profile cylinder, warded key, toilet lock, KABA cylinder
Applications	1-/2 panels, sidelight
Material	Aluminium, stainless steel, brass
Finishes	Anodised- and RAL-Colors (coated), stainless steel, brass
Specials	Tested acc. DIN 12209, Save for intense operational demands, Lock insert with „low-noise-whisper“ functionality, Adjustable lever handle follower

## Manual single action door systems

### STUDIO

- 182 STUDIO Rondo
- 190 STUDIO Classic
- 196 STUDIO Gala 2.0
- 202 STUDIO Arcos
- 210 STUDIO Medio

### OFFICE

- 214 OFFICE Junior
- 220 OFFICE Classic
- 226 OFFICE Arcos

### 232 Special hinges

### 236 PORTEO

### ALEXA door frames

- 240 AT 23 / AT 23E
- 244 AT 44
- 250 AT 50 with AT 44 / AT 50 with MR 28
- 256 Order form

### General accessories for the single action door range





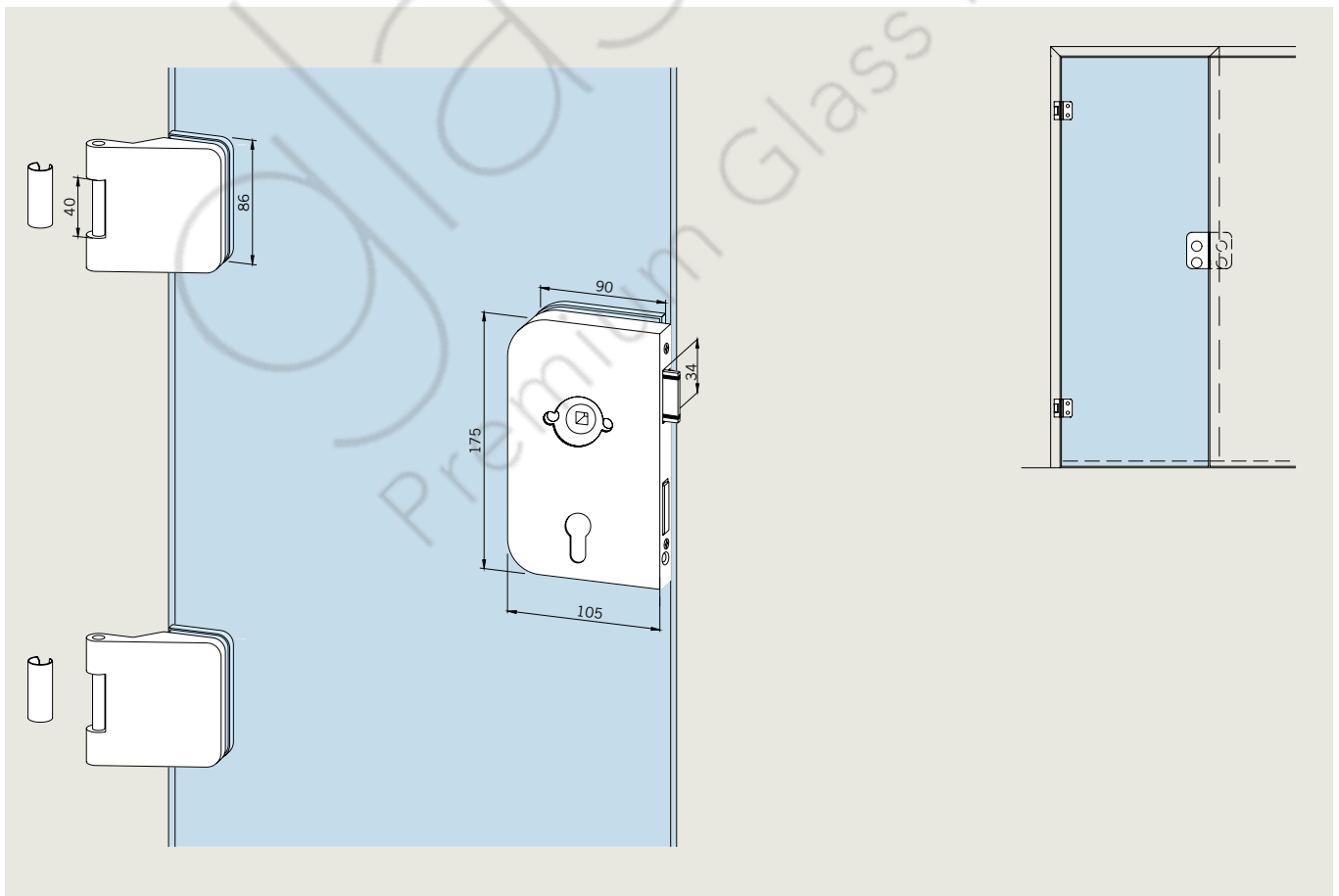

- 258 Frame pivots for internal doors
- 260 Frame pockets, push-on sleeves, strike plates
- 262 Door rails for internal doors
- 266 Floor bearings, profile cylinders, door bolts, door catches, floor sockets
- 270 Door closers, door closer accessories

### Example view for OFFICE Junior



Single components

Single action











Art. No.	Description	AL silver anod (150)	AL traffic white p-coat (300)	AL niro anod (157)	Brass satin chromed (500)	Brass polish chromed (501) Brass polish varnished (502)	Satin stainl steel (700)	AL special color anod (199)	AL special color p-coat (399)
		€/Piece	€/Piece	€/Piece	€/Piece	€/Piece	€/Piece	€/Piece	€/Piece
<b>Locks with follower for 8 – 10 mm glass thickness</b>									
	<b>11.260</b> Prepared for profile cylinder, public building type	- LH 99,50	99,50	125,00	232,00	254,00	184,00	180,00	180,00
	<b>11.261</b> do.	- RH 99,50	99,50	125,00	232,00	254,00	184,00	180,00	180,00
	<b>11.262</b> Warded key	- LH 79,00		107,00			164,00	140,00	140,00
	<b>11.263</b> do.	- RH 79,00		107,00			164,00	140,00	140,00
	<b>11.264</b> Non-locking latch	- LH 79,00	79,00	107,00			164,00	140,00	140,00
	<b>11.265</b> do.	- RH 79,00	79,00	107,00			164,00	140,00	140,00
	<b>11.266</b> Prepared for KABA cylinder	- LH 99,50		180,00				180,00	180,00
	<b>11.267</b> do.	- RH 99,50		180,00				180,00	180,00
	<b>11.206</b> Strike-box	-LH 83,00	83,00	122,00		225,00	164,00	141,00	141,00
	<b>11.207</b> do.	-RH 83,00	83,00	122,00		225,00	164,00	141,00	141,00
<b>Locks for levers with roses for 8 – 10 mm glass thickness</b>									
	<b>11.200</b> Prep. for profile cylinder, public building type	- LH 99,50	99,50	125,00		254,00	184,00	180,00	180,00
	<b>11.201</b> do.	- RH 99,50	99,50	125,00		254,00	184,00	180,00	180,00
	<b>11.210</b> Prepared for cylinder, lock corrosion resistant	- LH 220,00		248,00				338,00	338,00
	<b>11.211</b> do.	-RH 220,00		248,00				338,00	338,00

Complying to the current DIN EN 12209 – applicable in public buildings. Separately and successfully tested with 500,000 latch and 100,000 locking bolt operating cycles..

All locks with low noise whisper functionality and adjustable handle follower +1,5°-1°.





## Single components

Art. No.	Description		AL silver anod (150)	AL traffic white p-coat (300)	AL niro anod (157)	Brass polish chromed (501) Brass polish varnished (502)	Satin stainl steel (700)	AL special color anod (199)	AL special color p-coat (399)	
		€/Piece	€/Piece	€/Piece	€/Piece	€/Piece	€/Piece	€/Piece	€/Piece	
<b>Locks for levers with roses for 8 – 10 mm glass thickness</b>										
	<b>11.212</b> Non-locking latch public building type	- LH	99,50	125,00		184,00	180,00	180,00		
	<b>11.213</b> do.	- RH	99,50	125,00		184,00	180,00	180,00		
	<b>11.202</b> Warded key	- LH	79,00	107,00		164,00	140,00	140,00		
	<b>11.203</b> do.	- RH	79,00	107,00		164,00	140,00	140,00		
	<b>11.204</b> Toilet lock	- LH	118,00	160,00			212,00	212,00		
	<b>11.205</b> do.	- RH	118,00	160,00			212,00	212,00		
	<b>11.214</b> Toilet lock lock corrosion resistant	- LH	235,00	279,00			372,00	372,00		
	<b>11.215</b> do.	- RH	235,00	279,00			372,00	372,00		
	<b>11.240</b> Prepared for KABA cylinder	- LH	99,50	99,50	180,00		180,00	180,00		
	<b>11.241</b> do.	- RH	99,50	99,50	180,00		180,00	180,00		
	<b>11.228</b> OFFICE Classic lock, prepared for profile cylinder, with cylinder roses on both sides, public building type	- LH	134,00	162,00			220,00	220,00		
	<b>11.229</b> do.	-RH	134,00	162,00			220,00	220,00		
	<b>11.242</b> Prepared for profile cylinder, with cylinder roses on one side, public building type	- LH	116,00	147,00			198,00	198,00		
	<b>11.243</b> do.	- RH	116,00	147,00			198,00	198,00		
	<b>11.206</b> Strike-box	-LH	83,00	83,00	122,00	225,00	164,00	141,00	141,00	
	<b>11.207</b> do.	-RH	83,00	83,00	122,00	225,00	164,00	141,00	141,00	
<b>Door hinges for 8 – 10 mm glass thickness (12 mm on request)</b>										
	Door hinges with frame part Aluminium door hinge with sleeve, steel ball bearing and frame pivot									
	<b>11.231</b> for steel frames		36,00	36,00	47,00	102,00	73,00	60,00	60,00	
	<b>11.232</b> for wooden frames		37,00	37,00	49,00	104,00	74,50	62,50	62,50	
	<b>11.247</b> Aluminium door hinge with sleeve, steel ball bearing and frame pivot for steel frames for 120 mm frame pocket.		38,50	51,00			65,00	65,00		

Single components

Single action

Art. No.	Description	AL silver anod (150)	AL traffic white p-coat (300)	AL niro anod (157)	Brass polish chromed (501) Brass polish varnished (502)	Satin stainl steel (700)	AL special color anod (199)	AL special color p-coat (399)
		€/Piece	€/Piece	€/Piece	€/Piece	€/Piece	€/Piece	€/Piece
<b>Door hinges with frame part</b>								
<b>Door hinges 8 – 10 mm (12 mm on request)</b>								
	<b>11.233</b> Aluminium door hinge for heavy doors, plastic slide bearing, stainless steel bolt and frame pivot for 160 mm frame pocket	66,50		74,50			101,00	101,00
	<b>11.340</b> do. for 40 mm rebate depth,	90,50		97,00			125,00	125,00
	<b>11.298</b> Aluminium door hinge for heavy doors, steel ball bearing and frame pivot for wooden doors (frame pivots steel zinc coated)	77,50		83,00			115,00	115,00
<b>Door hinges</b>								
	<b>11.230</b> Aluminium door hinge with sleeve	25,50	25,50	33,00	84,50	61,00	44,00	44,00
	<b>11.237</b> Aluminium door hinge with sleeve, stainless steel pin, for 24 mm rebate depth	27,50	27,50	34,00			47,00	47,00
	<b>11.234</b> Aluminium door hinge with sleeve and steel ball bearing	27,50	27,50	38,50	94,00	65,00	52,00	52,00
	<b>11.238</b> Aluminium door hinge with sleeve for 40 mm rebate depth	37,00		47,00			67,50	67,50
	<b>11.244</b> Aluminium door hinge with sleeve, steel ball bearing for 40 mm rebate depth	40,00		50,00			73,00	73,00
	<b>11.245</b> Aluminium door hinge with sleeve, for 25 – 39 mm rebate depth	50,00		61,00			80,00	80,00
	<b>11.500</b> Stainless steel hinge for internal doors					51,00		
	<b>11.502</b> Stainless steel hinge for internal doors, for 40 mm rebate depth					54,50		
	<b>11.239</b> Aluminium door hinge with frame pivot for wooden frames	46,00	46,00	62,50			77,50	77,50
	<b>12.050</b> Aluminium door hinge with frame pivot (from 01.05.18: 12.090)	46,00	46,00	62,50			78,00	78,00
<b>Frame parts</b>								
	<b>11.310</b> Frame pivot for steel frames/OFFICE				Base parts 5,10			
	<b>11.309</b> Further frame parts on pages 258 – 259				Base parts 3,70			

Notes



Single action

# OFFICE Classic

Single action



Technical data	
Glass	TSG
Glass thickness	8, 10, 12 mm (please indicate with the order)
max. door weight	55 kg
Lock application	non-locking latch, profile cylinder, warded key, toilet lock, KABA cylinder
Applications	1-/2 panels, sidelight
Material	Aluminium
Finishes	Anodised- and RAL-Colors (coated)
Specials	Tested acc. DIN 12209, Save for intense operational demands, Lock insert with „low-noise-whisper“ functionality, Adjustable lever handle follower

## Manual single action door systems

### STUDIO

- 182 STUDIO Rondo
- 190 STUDIO Classic
- 196 STUDIO Gala 2.0
- 202 STUDIO Arcos
- 210 STUDIO Medio

### OFFICE

- 214 OFFICE Junior
- 220 OFFICE Classic
- 226 OFFICE Arcos

### 232 Special hinges

### 236 PORTEO

### ALEXA door frames

- 240 AT 23 / AT 23E
- 244 AT 44
- 250 AT 50 with AT 44 / AT 50 with MR 28
- 256 Order form

### General accessories for the single action door range

- 258 Frame pivots for internal doors
- 260 Frame pockets, push-on sleeves, strike plates
- 262 Door rails for internal doors
- 266 Floor bearings, profile cylinders, door bolts, door catches, floor sockets
- 270 Door closers, door closer accessories

### Example view for OFFICE Classic

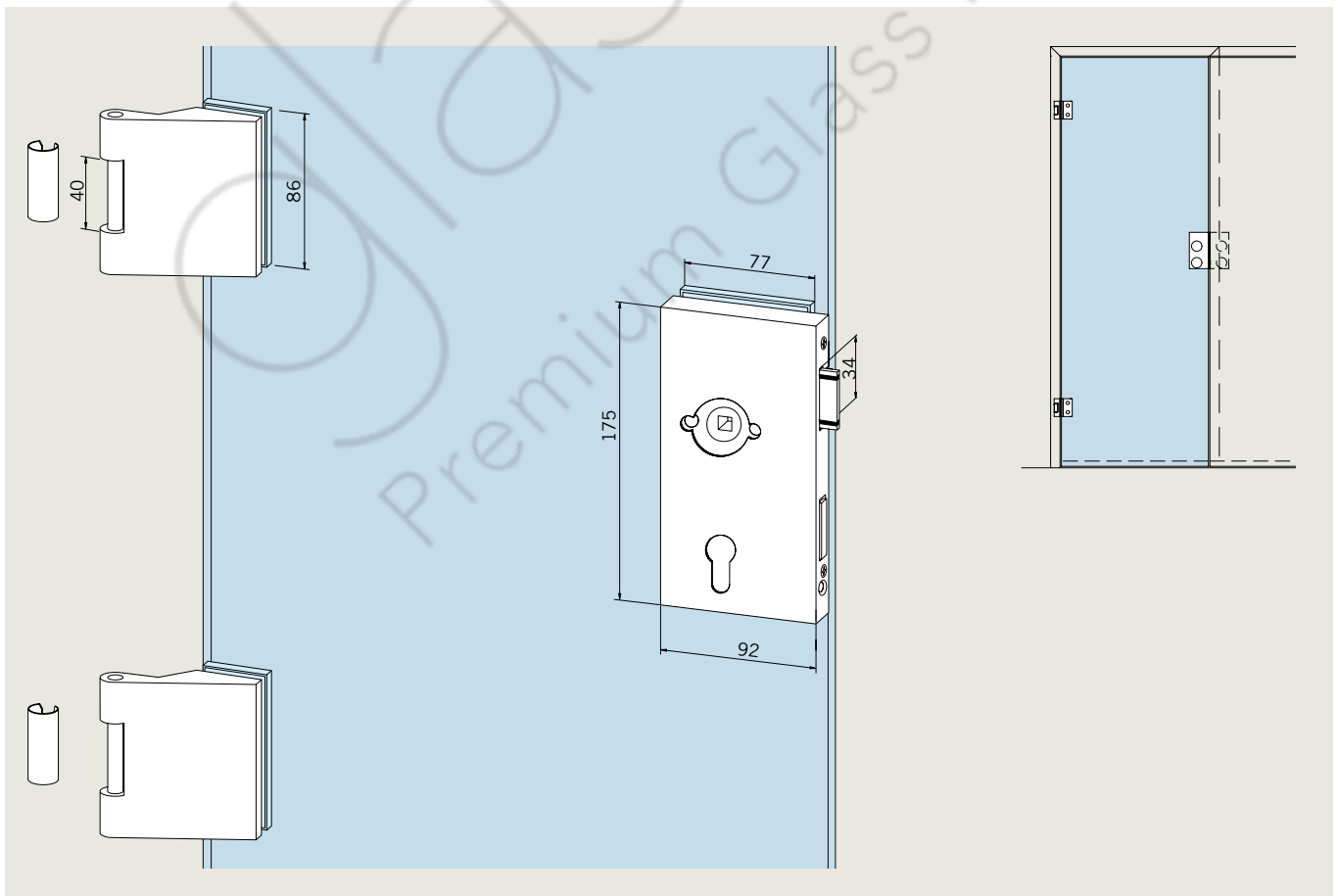

Single components

AL silver anod (150)	AL niro anod (157)	AL special color anod (199)	AL special color p-coat (399)
----------------------	--------------------	-----------------------------	-------------------------------







Art. No.	Description	€/Piece	€/Piece	€/Piece	€/Piece
<b>Locks with follower for 8 – 12 mm glass</b>					
	<b>11.280</b> Prepared for profile cylinder, public building type	- LH 99,50	125,00	180,00	180,00
	<b>11.281</b> do.	- RH 99,50	125,00	180,00	180,00
	<b>11.282</b> Warded key	- LH 79,00	107,00	140,00	140,00
	<b>11.283</b> do.	- RH 79,00	107,00	140,00	140,00
	<b>11.284</b> Non-locking latch	- LH 79,00	107,00	140,00	140,00
	<b>11.285</b> do.	- RH 79,00	107,00	140,00	140,00
	<b>11.320</b> Prepared for KABA cylinder	- LH 99,50	180,00	180,00	180,00
	<b>11.321</b> do.	- RH 99,50	180,00	180,00	180,00
	<b>11.286</b> Strike-box	- LH 83,00	122,00	140,00	140,00
	<b>11.287</b> do.	- RH 83,00	122,00	140,00	140,00

Single action

Complying to the current DIN EN 12209 – applicable in public buildings. Separately and successfully tested with 500,000 latch and 100,000 locking bolt operating cycles..

All locks with low noise whisper functionality and adjustable handle follower +1,5°–1°.

## Single components

		AL silver anod (150)	AL traffic white p-coat (300)	AL niro anod (157)	AL special color anod (199)	AL special color p-coat (399)
Art. No.	Description	€/Piece	€/Piece	€/Piece	€/Piece	€/Piece
<b>Locks for levers with roses for 8 – 12 mm glass</b>						
	<b>11.270</b> Prepared for profile cylinder, public building type	- LH 99,50	99,50	125,00	180,00	180,00
	<b>11.271</b> do.	- RH 99,50	99,50	125,00	180,00	180,00
	<b>11.272</b> Warded key	- LH 79,00		107,00	140,00	140,00
	<b>11.273</b> do.	- RH 79,00		107,00	140,00	140,00
	<b>11.274</b> Non-locking latch	- LH 79,00		107,00	140,00	140,00
	<b>11.275</b> do.	- RH 79,00		107,00	140,00	140,00
	<b>11.276</b> Toilet lock	- LH 118,00	118,00	160,00	212,00	212,00
	<b>11.277</b> do.	- RH 118,00	118,00	160,00	212,00	212,00
	<b>11.278</b> Prepared for KABA cylinder	- LH 99,50		180,00	180,00	180,00
	<b>11.279</b> do.	- RH 99,50		180,00	180,00	180,00
	<b>11.286</b> Strike-box	- LH 83,00		122,00	140,00	140,00
	<b>11.287</b> do.	- RH 83,00		122,00	140,00	140,00

Complying to the current DIN EN 12209 – applicable in public buildings. Separately and successfully tested with 500,000 latch and 100,000 locking bolt operating cycles..

All locks with low noise whisper functionality and adjustable handle follower +1,5%–1°.

Single components

Single action

Art. No.	Description	AL silver anod (150)	AL traffic white p-coat (300)	AL niro anod (157)	Satin stainl steel (700)	AL special color anod (199)	AL special color p-coat (399)
<b>Door hinges with frame part 8 – 10 mm (12 mm on request)</b>							
	<b>11.289</b> Aluminium door hinge with sleeve, steel ball bearing and frame pivot for steel frames	36,00	36,00	47,00		60,00	60,00
	<b>11.290</b> Aluminium door hinge with sleeve, steel ball bearing and frame pivot for wooden frames	37,00	37,00	49,00		62,50	62,50
	<b>11.293</b> Aluminium door hinge with sleeve, steel ball bearing and frame pivot for 120 mm frame pocket	38,50		51,00		65,00	65,00
	<b>11.291</b> Aluminium door hinge for heavy doors, plastic slide bearing and frame pivot for 160 mm frame pocket	64,00		70,00		98,00	98,00
	<b>11.341</b> do. for 40 mm rebate depth,	90,50		97,00		125,00	125,00
	<b>11.342</b> OFFICE Classic door hinge with frame pivot for wooden frames	46,00		62,50		77,50	77,50
	<b>11.294</b> Aluminium door hinge with frame pivot for non-rebated frames (from 01.05.18: 12.091)	46,00	46,00	62,50		78,00	78,00
<b>Door hinges 24 mm rebate depth</b>							
	<b>11.288</b> Aluminium door hinge with sleeve	25,50	25,50	33,00		44,00	44,00
	<b>11.500</b> Stainless steel hinge for internal doors				51,00		
	<b>11.292</b> Aluminium door hinge with sleeve and steel ball bearing	27,50		38,50		52,00	52,00
<b>Door hinges 40 mm rebate depth</b>							
	<b>11.295</b> Aluminium door hinge with sleeve, for 40 mm rebate depth	37,00		47,00		62,50	62,50
	<b>11.502</b> Stainless steel hinge for internal doors, for 40 mm rebate depth				54,50		
	<b>11.296</b> Aluminium door hinge with sleeve, steel ball bearing, for 40 mm rebate depth	40,00	40,00	50,00		73,00	73,00
<b>Frame pivots</b>							
	<b>11.310</b> Frame pivot for wooden frames/Office	Base parts 5,10					
	<b>11.309</b> Frame pivot for steel frames/Office	Base parts 3,70					

Further frame parts on pages 258 – 259



**Notes**



Single action

# OFFICE Arcos

Single action



reddot design award



Technical data	
Glass	TSG
Glass thickness	8, 10, 12 mm (please indicate with the order)
max. door weight	55 kg
Lock application	non-locking latch, profile cylinder, warded key, KABA cylinder
Applications	1-/2 panels, sidelight
Material	Aluminium, Brass
Finishes	Anodised- and RAL-Colors (coated)
Specials	Tested acc. DIN 12209, Save for intense operational demands, Lock insert with „low-noise-whisper“ functionality, Adjustable lever handle follower

## Manual single action door systems

### STUDIO

- 182 STUDIO Rondo
- 190 STUDIO Classic
- 196 STUDIO Gala 2.0
- 202 STUDIO Arcos
- 210 STUDIO Medio

### OFFICE

- 214 OFFICE Junior
- 220 OFFICE Classic
- 226 OFFICE Arcos

### 232 Special hinges

### 236 PORTEO

### ALEXA door frames

- 240 AT 23 / AT 23E
- 244 AT 44
- 250 AT 50 with AT 44 / AT 50 with MR 28
- 256 Order form

### General accessories for the single action door range



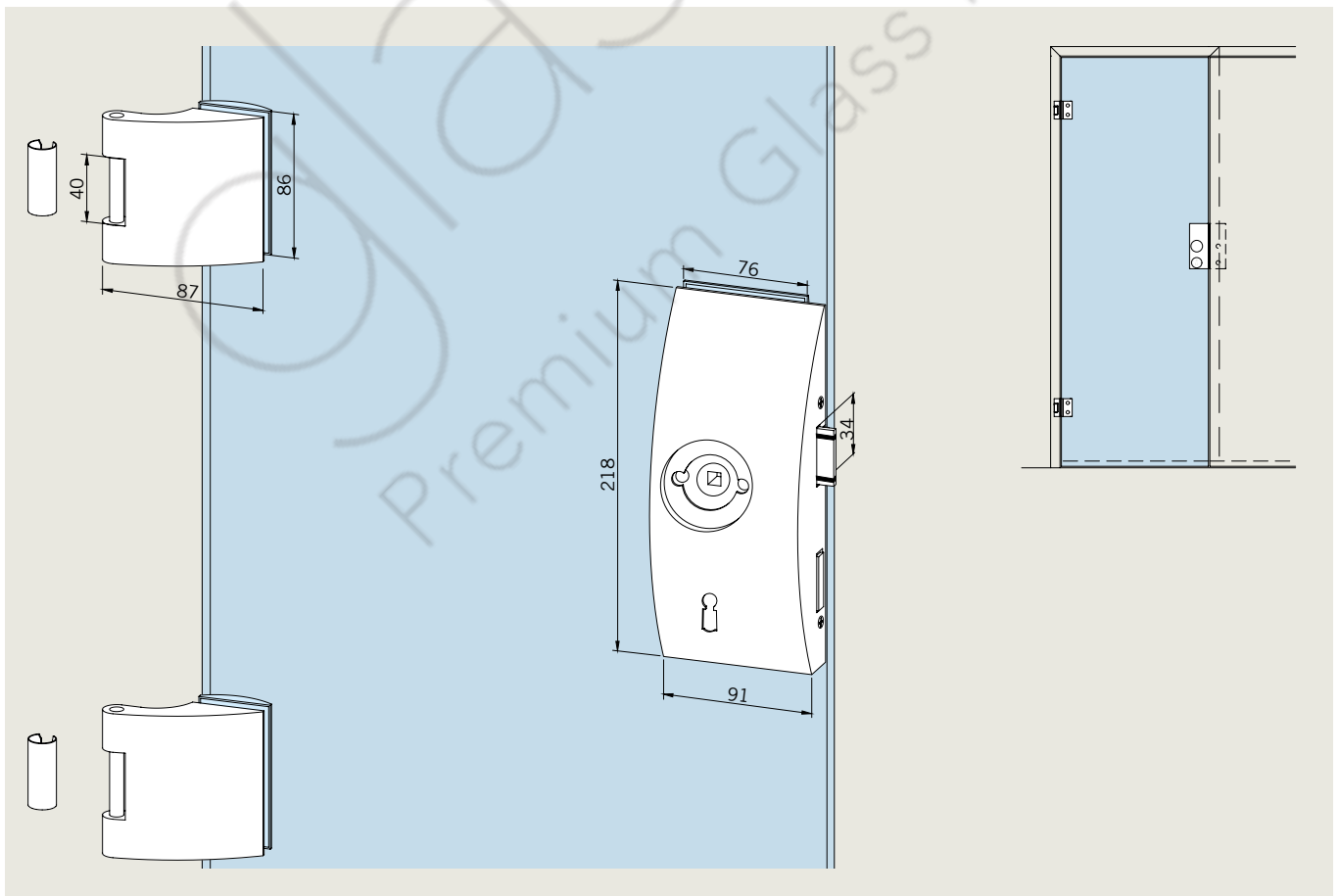

- 258 Frame pivots for internal doors
- 260 Frame pockets, push-on sleeves, strike plates
- 262 Door rails for internal doors
- 266 Floor bearings, profile cylinders, door bolts, door catches, floor sockets
- 270 Door closers, door closer accessories

### Example view for OFFICE Arcos



Single components

AL EV1-Deco anod (114)	AL traffic white p-coat (300)	AL niro anod (157)	AL special color anod (199)	AL special color p-coat (399)
---------------------------------	---	-----------------------------	---	---





Art. No.	Description		€/Piece	€/Piece	€/Piece	€/Piece	€/Piece
<b>Locks with follower for 8 – 10 mm glass thickness</b>							
	<b>25.260</b> Prepared for profile cylinder, with nightlatch function	- LH	106,00		134,00	190,00	190,00
	<b>25.261</b> do.	- RH	106,00		134,00	190,00	190,00
	<b>25.262</b> Warded key	- LH	83,00		114,00	151,00	151,00
	<b>25.263</b> do.	- RH	83,00		114,00	151,00	151,00
	<b>25.264</b> Non-locking-latch	- LH	83,00		114,00	151,00	151,00
	<b>25.265</b> do.	- RH	83,00		114,00	151,00	151,00
	<b>25.206</b> Strike-box	- LH	98,00	98,00	129,00	156,00	156,00
	<b>25.207</b> do.	- RH	98,00	98,00	129,00	156,00	156,00

Single action

Complying to the current DIN EN 12209 – applicable in public buildings. Separately and successfully tested with 500,000 latch and 100,000 locking bolt operating cycles..

All locks with low noise whisper functionality and adjustable handle follower +1,5°-1°.

## Single components









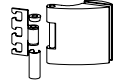
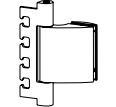

			AL EV1-Deco anod (114)	AL traffic white p-coat (300)	AL niro anod (157)	AL special color anod (199)	AL special color p-coat (399)
Art. No.	Description		€/Piece	€/Piece	€/Piece	€/Piece	€/Piece
<b>Locks for levers with roses for 8 – 10 mm glass thickness</b>							
	<b>25.200</b> Prepared for profile cylinder, with nightlatch function	- LH	106,00	106,00	134,00	191,00	191,00
	<b>25.201</b> do.	- RH	106,00	106,00	134,00	191,00	191,00
	<b>25.202</b> Warded key	- LH	83,00		114,00	151,00	151,00
	<b>25.203</b> do.	- RH	83,00		114,00	151,00	151,00
	<b>25.208</b> Non-locking-latch	- LH	83,00		114,00	151,00	151,00
	<b>25.209</b> do.	- RH	83,00		114,00	151,00	151,00
	<b>25.240</b> Prepared for KABA cylinder	- LH	106,00		134,00	190,00	190,00
	<b>25.241</b> do.	- RH	106,00		134,00	190,00	190,00
	<b>25.206</b> Strike-box	- LH	98,00	98,00	129,00	156,00	156,00
	<b>25.207</b> do.	- RH	98,00	98,00	129,00	156,00	156,00

Complying to the current DIN EN 12209 – applicable in public buildings. Separately and successfully tested with 500,000 latch and 100,000 locking bolt operating cycles..

All locks with low noise whisper functionality and adjustable handle follower +1,5%–1°.







Single components

Single action

Art. No.	Description	AL EV1-Deco anod (114)	AL traffic white p-coat (300)	AL niro anod (157)	Brass polish chromed (501) Brass polish varnished (502)	AL special color anod (199)	AL special color p-coat (399)
		€/Piece	€/Piece	€/Piece	€/Piece	€/Piece	€/Piece
<b>Door hinges with frame part 8 – 10 mm</b>							
	<b>25.231</b> Aluminium door hinge with sleeve, steel ball bearing and frame pivot for steel frames	37,00	37,00	49,00	only (501) 105,00	64,00	64,00
	<b>25.232</b> Aluminium door hinge with sleeve, steel ball bearing and frame pivot for wooden frames	38,50	38,50	50,00	116,00	65,00	65,00
	<b>25.247</b> Aluminium door hinge with sleeve, steel ball bearing and frame pivot for steel frames, 120 mm frame pocket	41,50		52,00		67,50	67,50
	<b>25.233</b> ARCOS hinge for project doors with plastic slide bearing and with 160 mm type frame pocket	68,50		79,00		107,00	107,00
	<b>25.340</b> do. for 40 mm rebate depth	94,00		102,00		133,00	133,00
	<b>25.239</b> Door hinge with frame part to be recessed into wooden frames	27,50	27,50	36,00		50,00	50,00
<b>Door hinges 8 – 10 mm</b>							
	<b>25.230</b> Aluminium door hinge with sleeve	25,50	26,50	34,00	98,00	47,00	47,00
	<b>25.238</b> do. for 40 mm rebate depth	40,00		51,00		73,00	73,00
	<b>25.234</b> Aluminium door hinge with sleeve and steel ball bearing	30,50	30,50	41,50	105,00	54,50	54,50
	<b>25.244</b> do. for 40 mm rebate depth	42,50		53,00		76,50	76,50
<b>Frame parts</b>							
	<b>11.310</b> Frame pivot for wooden frames/Office	Base parts 5,10					
	<b>11.309</b> Frame pivot for steel frames/Office	Base parts 3,70					

Further frame parts on pages 258 – 259

## Single components

		Base parts (000)	AL EV1-Deco anod (114)	AL silver brilliant anod (103)	AL niro anod (157)	AL special color anod (199)	AL special color p-coat (399)
Art. No.	Description	€/Piece	€/Piece	€/Piece	€/Piece	€/Piece	€/Piece
	Special hinges						
	<b>25.401</b> Pair of ARCOS corner hinges for 8 mm glass thickness	54,50	68,50	81,00	83,00	83,00	
	<b>25.409</b> Pair of ARCOS corner hinges for 10 mm glass thickness	57,50	70,00	83,00	86,00	86,00	
	<b>12.016</b> Pair of floor/ceiling pivot bearing For 12.001 and 12.009	18,50					
	<b>12.014</b> Piece of floor/ceiling pivot bearing bottom left/ top right	10,00					
	<b>12.015</b> Piece of floor/ceiling pivot bearing bottom right/ top left	10,00					
	<b>12.003</b> Frame fixed pivot	10,00					
	<b>12.004</b> Screw-in pivot	8,90					

# Special hinges

Single action



Technical data	
Glass	TSG
Glass thickness	8, 10 mm
max. door weight	depending on the hinge type
Applications	1/2-panels, sidelight
Material	Aluminium, stainless steel, brass
Finishes	Anodised- and RAL-Colors (coated), brass
Specials	Tested acc. DIN 1670



## Manual single action door systems

### STUDIO

182	STUDIO Rondo
190	STUDIO Classic
196	STUDIO Gala 2.0
202	STUDIO Arcos
210	STUDIO Medio

### OFFICE

214	OFFICE Junior
220	OFFICE Classic
226	OFFICE Arcos

### 232 Special hinges

### 236 PORTEO

### ALEXA door frames

240	AT 23 / AT 23E
244	AT 44
250	AT 50 with AT 44 / AT 50 with MR 28
256	Order form

### General accessories for the single action door range

258	Frame pivots for internal doors
260	Frame pockets, push-on sleeves, strike plates
262	Door rails for internal doors
266	Floor bearings, profile cylinders, door bolts, door catches, floor sockets
270	Door closers, door closer accessories



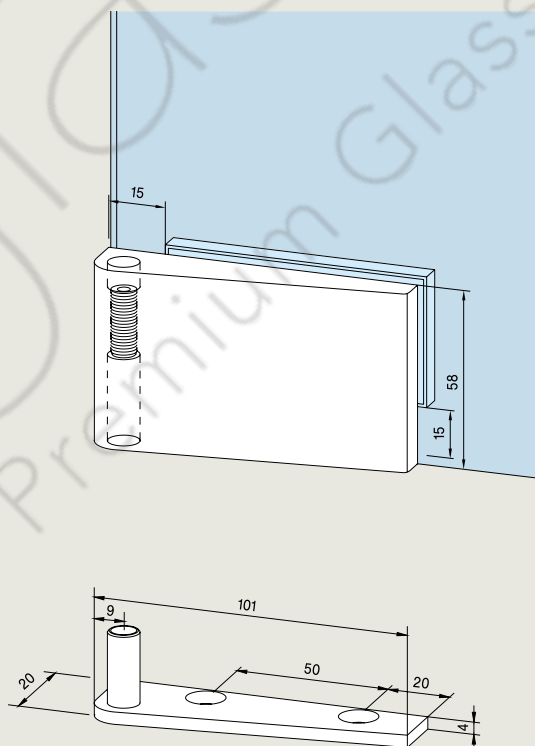



### Example view for special hinges



Complete sets

Base parts (000)	AL silver anod (150)	AL traffic white p-coat (300)	AL niro anod (157)	AL special color anod (199)	AL special color p-coat (399)
------------------	----------------------	-------------------------------	--------------------	-----------------------------	-------------------------------

Single action

Art. No.	Description		€/Piece	€/Piece	€/Piece	€/Piece	€/Piece	€/Piece
	<b>12.040 Set of corner hinges,</b> for 8/10 mm glass thickness, door weight max 80 kg., door width max. 1100 mm, consisting of: 1 floor pivot 1 bottom corner hinge (height adjustable) 1 top-pivot 1 top corner hinge	- LH	85,50	85,50	115,00	120,00	120,00	
	<b>12.041 do.</b>	- RH	85,50	85,50	115,00	120,00	120,00	
	<b>Single components</b>							
	<b>12.001 Pair of corner hinges</b> for 8 mm glass thickness		47,00	47,00	70,50	73,00	73,00	
	<b>12.009 Pair of corner hinges</b> for 10 mm glass thickness		50,00	51,50	72,00		75,50	
	<b>12.016 Pair of floor socket/top-pivot</b> for 12.001 and 12.009		18,50					
	<b>12.014 Piece of floor socket/top-pivot</b> left bottom/top right		10,00					
	<b>12.015 Piece of floor socket/top-pivot</b> right bottom/left top		10,00					
	<b>12.003 Frame fixed pivot</b>		10,00					
	<b>12.004 Screw-in pivot</b>		8,90					

## Single components

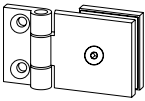
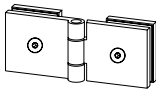
		AL silver anod (150)	AL niro anod (157)	AL special color anod (199)	AL special color p-coat (399)
Art. No.	Description	€/Piece	€/Piece	€/Piece	€/Piece
<b>Screw-on hinges</b>					
	<b>12.010</b> Screw-on hinge, 49 mm high, without cover caps	34,00	52,50	52,50	52,50
	<b>12.011</b> do., with 3 cover caps	41,50	64,50	64,50	64,50
	<b>12.012</b> do., with cover cap only for clamping plate, 86 mm high	41,50	64,50	64,50	64,50
<b>Screw-in hinges</b>					
	<b>12.030</b> Screw-in hinge, 49 mm high, without cover caps	40,00	58,50	58,50	58,50
	<b>12.031</b> do., with 4 cover caps	57,50	85,50	85,50	85,50
	<b>12.032</b> do., with cover caps only for clamping plates, 86 mm high	57,50	85,50	85,50	85,50

# PORTEO

Single action



reddot design award

Technical data	
Glass	TSG
Glass thickness	8, 10 mm
Max. door weight	80 kg
Lock applications	suitable for combination with all available interior door locks and hinges shown in this price list
Applications	single-leaf
Material	Aluminium
Finishes	Silver varnished
Specials	Easy to retrofit Range of add-on accessories (e.g. hand-held transmitter) Recipient of the reddot award and "Le Janus de l'Industrie 2007"

## Manual single action door systems

### STUDIO

- 182 STUDIO Rondo
- 190 STUDIO Classic
- 196 STUDIO Gala 2.0
- 202 STUDIO Arcos
- 210 STUDIO Medio

### OFFICE

- 214 OFFICE Junior
- 220 OFFICE Classic
- 226 OFFICE Arcos

### 232 Special hinges

### 236 PORTEO

### ALEXA door frames

- 240 AT 23 / AT 23E
- 244 AT 44
- 250 AT 50 with AT 44 / AT 50 with MR 28
- 256 Order form

### General accessories for the single action door range

- 258 Frame pivots for internal doors
- 260 Frame pockets, push-on sleeves, strike plates
- 262 Door rails for internal doors
- 266 Floor bearings, profile cylinders, door bolts, door catches, floor sockets
- 270 Door closers, door closer accessories

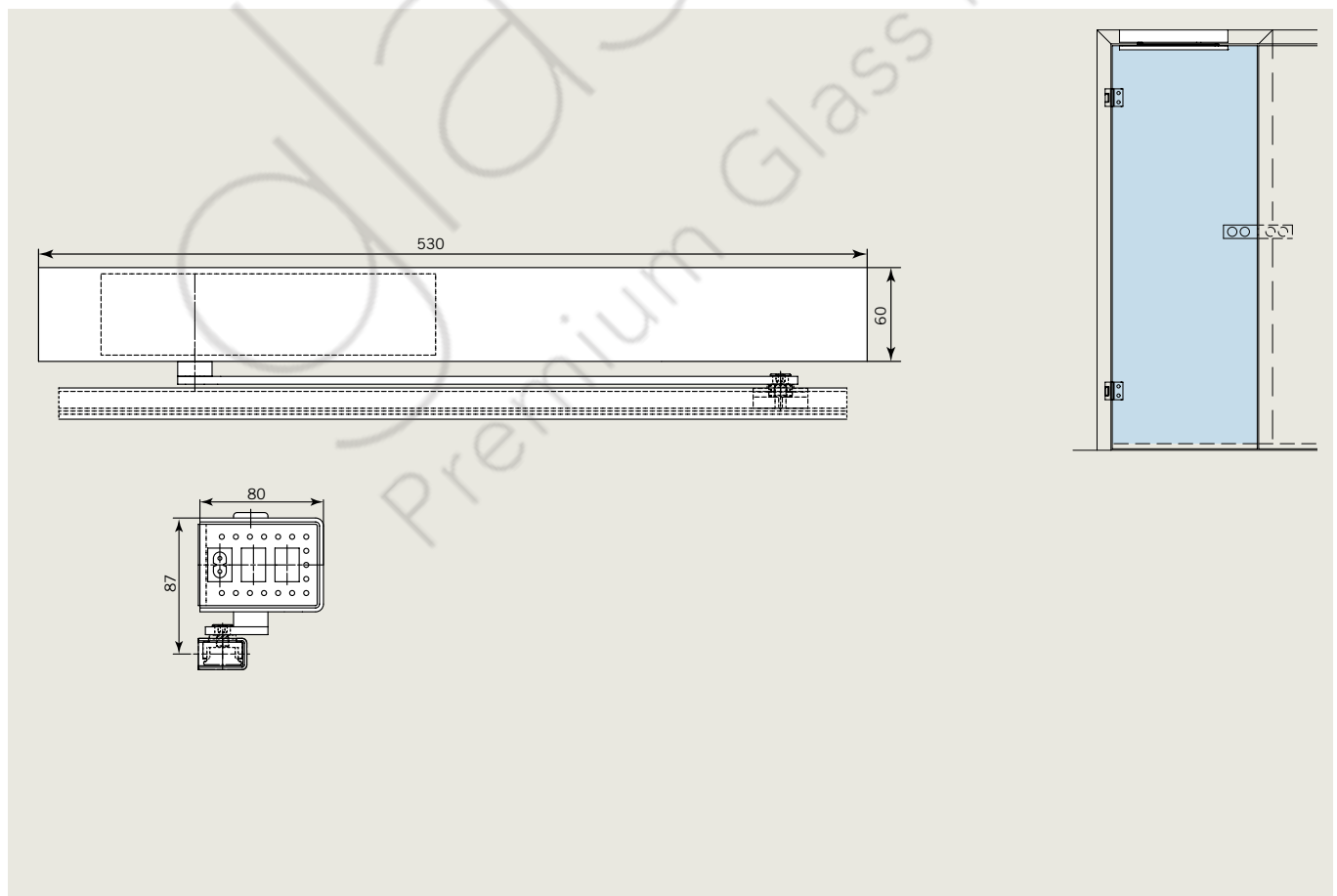

### Example view for PORTEO



Complete set

AL  
silver EV1  
anod  
(101)

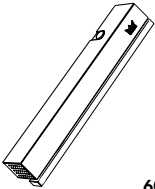
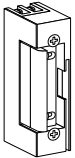
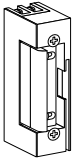
Single action

Art. No.	Description	€/Piece
	<b>60010001 PORTEO Door Assistant,</b> incl. slide channel, lever arm and mounting backplate, for all four mounting configurations, non-handed, CEE7/7 plug connector, silver finish	X
	<b>Single components</b>	
	<b>60041301</b> Glass door saddle plate (slide-over bracket) for PORTEO slide channel, for laminated safety glass (LSG) or toughed safety glass (TSG) sheets, silver	X
	<b>15117124</b> Standard strike, fail-secure locking, Basic model Symmetrical standard strike, operating current 24 V DC, with adjustable latch, non-handed, suitable for both rebated and non-rebated (flush-closing) doors, including free-wheeling	X
	<b>15137124</b> Standard electric strike, fail-safe locking mode, Basic-Safe model, symmetrical standard strike, off-load/quiescent current 24 V DC, with adjustable latch, non-handed, suitable for rebated and non-rebated (flush-closing) doors, incl. freewheeling diode, without strike plate	X
	The flush-mounted S55 switch, white, with frame-type trim, Art. No. 19144701170 is shown on page 177 (CS 80 MAGNEO)	
	For more accessories for switch-type activators please see page 177.	

**Notes**



Single action

# ALEXA AT 23 / AT 23E

Single action



Technical data	
Glass	TSG
Glass thickness	8, 10 mm
Max. door weight	40 kg (with 2 hinges); 55 kg (with 3 hinges)
Material	Aluminium
Standard finishes	Anodised colors
Specials	Customized and pre-assembled door frames. Alternative: Single parts in stock lengths for maximum flexibility



## Manual single action door systems

### STUDIO

182	STUDIO Rondo
190	STUDIO Classic
196	STUDIO Gala 2.0
202	STUDIO Arcos
210	STUDIO Medio

### OFFICE

214	OFFICE Junior
220	OFFICE Classic
226	OFFICE Arcos

### 232 Special hinges

### 236 PORTEO

### ALEXA door frames

240	AT 23 / AT 23E
244	AT 44
250	AT 50 with AT 44 / AT 50 with MR 28
256	Order form

### General accessories for the single action door range

258	Frame pivots for internal doors
260	Frame pockets, push-on sleeves, strike plates
262	Door rails for internal doors
266	Floor bearings, profile cylinders, door bolts, door catches, floor sockets
270	Door closers, door closer accessories

### Section drawings

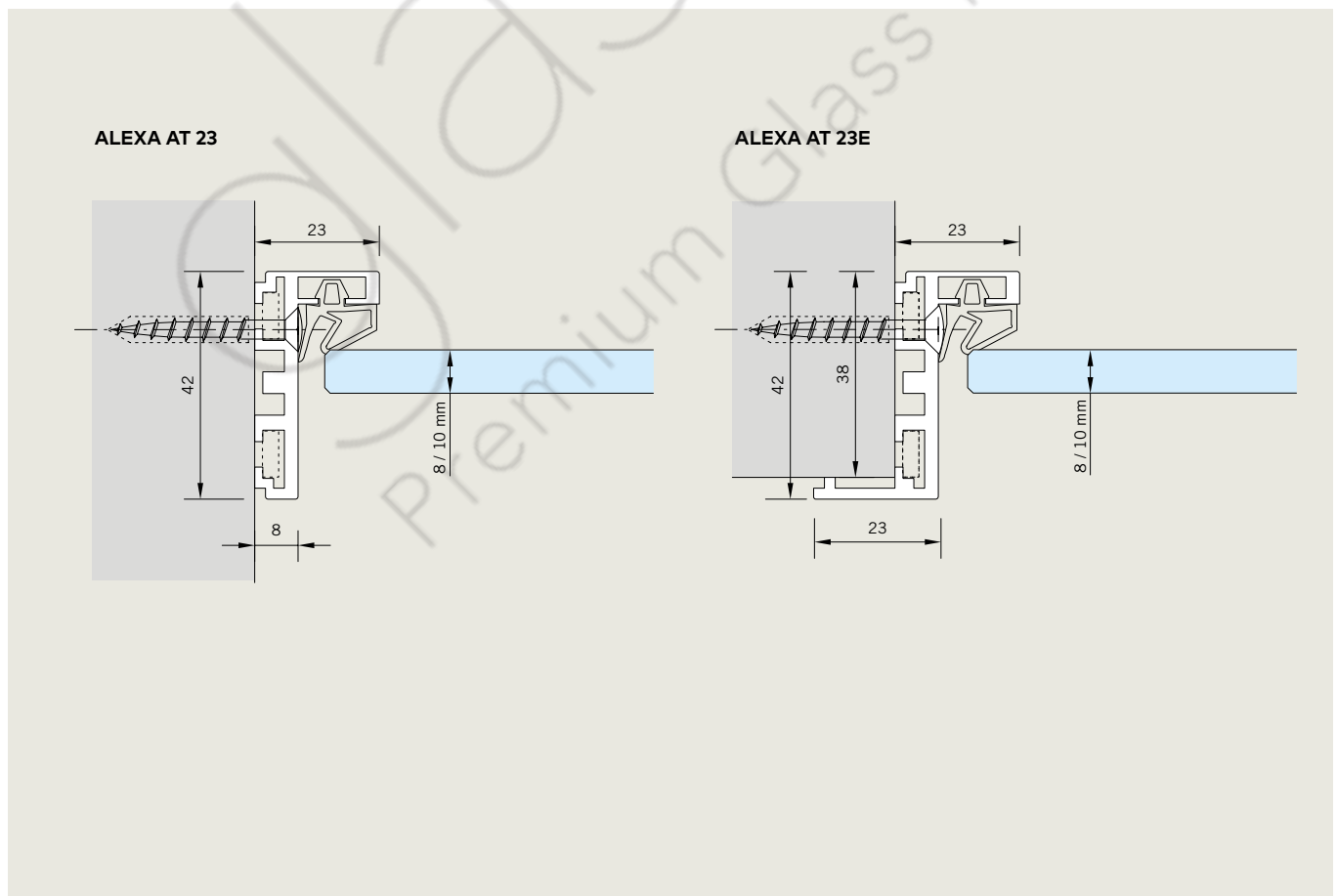

Pre-assembled door frame elements

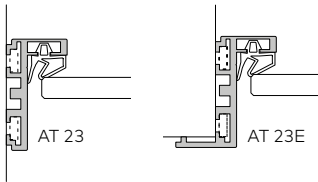

AL silver EV1 anod (101) AL sim satin stainl steel anod C31 (113)

Frame type Description

**Frames:**

Included in the price and scope of supply are, depending on system type, all made-to-measure frame profiles, rubber strike profiles, all the tapped holes and screws for aluminium hinges and milling cuts for latches.

**ALEXA AT 23 / AT 23E can only be combined with hinges 11.294, 12.090 or 25.451**

**All ALEXA AT 23 / AT 23E frame types are compatible with locks in the following design:**

- STUDIO Rondo
- STUDIO Classic
- STUDIO Gala 2.0
- STUDIO Arcos
- STUDIO Medio
- OFFICE Junior
- OFFICE Classic
- OFFICE Arcos

Single action

	201 (AT 23)	Standard preparation per frame plus Linear meter profile	€/Piece	95,00	95,00	€/m	23,50	40,00
	202 (AT 23)*	Standard preparation per frame plus Linear meter profile	€/Piece	115,00	115,00	€/m	23,50	40,00
	203 (AT 23)	Standard preparation per frame plus Linear meter profile	€/Piece	126,00	126,00	€/m	23,50	40,00
	301 (AT 23E)	Standard preparation per frame plus Linear meter profile	€/Piece	95,00	95,00	€/m	27,00	45,50
	302 (AT 23E)*	Standard preparation per frame plus Linear meter profile	€/Piece	115,00	115,00	€/m	27,00	45,50
	303 (AT 23E)	Standard preparation per frame plus Linear meter profile	€/Piece	126,00	126,00	€/m	27,00	45,50

For enquiries / orders please use the attached form.

\* Please note when ordering fittings: With these frame types, three hinges are required.

## Single components

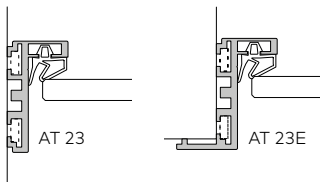





Base parts (000)	AL silver EV1 anod (101)	AL sim satin stainl steel anod C31 (113)
------------------	--------------------------	--

Art. No. Description

ALEXA AT 23 / AT 23E can only be combined with hinges 11.294, 12.090 or 25.451

All ALEXA AT 23 / AT 23E frame types are compatible with locks in the following design:

STUDIO Rondo	OFFICE Junior
STUDIO Classic	OFFICE Classic
STUDIO Gala 2.0	OFFICE Arcos
STUDIO Arcos	
STUDIO Medio	

	<b>32.010</b> ALEXA AT 23 frame profile drilled with template stock length 5500 mm	€/m	21,50	38,00
	<b>32.011</b> ALEXA AT 23 frame profile drilled with template stock length 5500 mm	€/m	25,00	43,50
	<b>32.012</b> Rubber strike profile for ALEXA AT 23 / AT 23E frame profile stock length 20 m (on a roll)	€/m	3,10	
	<b>32.013</b> Rubber strike profile for ALEXA AT 23 / AT 23E frame profile fixed length	€/m	3,90	
	<b>32.014</b> ALEXA AT 23 / AT 23E corner connector bracket (set of 4)	€/Set	20,00	
	<b>32.034</b> Screws for hinges M5 x 8 stainless steel for ALEXA AT 23 / AT 23E frame profile (set of 6)	€/Set	5,30	

# ALEXA AT 44

Single action



Technical data	
Glass	TSG
Glass thickness	8, 10 mm
Max. door weight	45 - 65 kg (depending on hinge type)
Material	Aluminium
Standard finishes	Anodised colors
Specials	Customized and pre-assembled door frames. Alternative: Single parts in stock lengths for maximum flexibility

## Manual single action door systems

### STUDIO

182	STUDIO Rondo
190	STUDIO Classic
196	STUDIO Gala 2.0
202	STUDIO Arcos
210	STUDIO Medio

### OFFICE

214	OFFICE Junior
220	OFFICE Classic
226	OFFICE Arcos

### 232 Special hinges

### 236 PORTEO

### ALEXA door frames

240	AT 23 / AT 23E
244	AT 44
250	AT 50 with AT 44 / AT 50 with MR 28
256	Order form

### General accessories for the single action door range

258	Frame pivots for internal doors
260	Frame pockets, push-on sleeves, strike plates
262	Door rails for internal doors
266	Floor bearings, profile cylinders, door bolts, door catches, floor sockets
270	Door closers, door closer accessories

### Section drawing

#### ALEXA AT 44

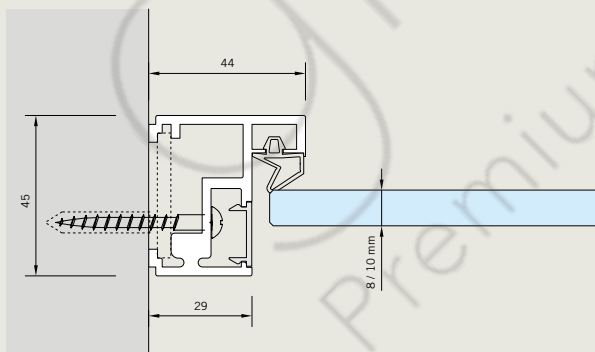

Pre-assembled door frame elements

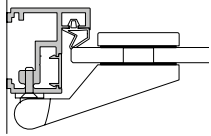

AL silver EV1 anod (101)  
AL sim satin stainl steel anod C31 (113)

Frame type Description

**Frames:**

Included in the price and scope of supply are, depending on system type, all made-to-measure frame profiles, glass edging profiles, clips profiles, strike and sealing profiles, corner connectors, screw-on frame portions, overpanel brackets and all necessary tapped holes and screws.

Matching with all DORMA fittings for rebate depth of 24 mm.

All ALEXA AT 44 frame types are compatible with locks in the following design:

- STUDIO Rondo
- STUDIO Classic
- STUDIO Gala 2.0
- STUDIO Arcos
- STUDIO Medio
- OFFICE Junior
- OFFICE Classic
- OFFICE Arcos

Single action

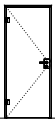
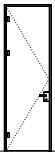
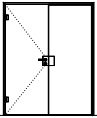
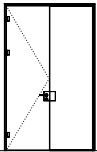
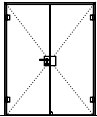
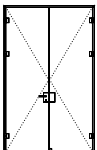
	501	Standard preparation per frame plus Linear meter profile	<table border="0"> <tr> <td>€/Piece</td> <td style="background-color: #d9ead3;">128,00</td> <td style="background-color: #d9ead3;">128,00</td> </tr> <tr> <td>€/m</td> <td style="background-color: #d9ead3;">58,50</td> <td style="background-color: #d9ead3;">87,50</td> </tr> </table>	€/Piece	128,00	128,00	€/m	58,50	87,50
€/Piece	128,00	128,00							
€/m	58,50	87,50							
	502*	Standard preparation per frame plus Linear meter profile	<table border="0"> <tr> <td>€/Piece</td> <td style="background-color: #d9ead3;">154,00</td> <td style="background-color: #d9ead3;">154,00</td> </tr> <tr> <td>€/m</td> <td style="background-color: #d9ead3;">58,50</td> <td style="background-color: #d9ead3;">87,50</td> </tr> </table>	€/Piece	154,00	154,00	€/m	58,50	87,50
€/Piece	154,00	154,00							
€/m	58,50	87,50							
	503	Standard preparation per frame plus Linear meter profile	<table border="0"> <tr> <td>€/Piece</td> <td style="background-color: #d9ead3;">131,00</td> <td style="background-color: #d9ead3;">131,00</td> </tr> <tr> <td>€/m</td> <td style="background-color: #d9ead3;">61,50</td> <td style="background-color: #d9ead3;">97,00</td> </tr> </table>	€/Piece	131,00	131,00	€/m	61,50	97,00
€/Piece	131,00	131,00							
€/m	61,50	97,00							
	504*	Standard preparation per frame plus Linear meter profile	<table border="0"> <tr> <td>€/Piece</td> <td style="background-color: #d9ead3;">156,00</td> <td style="background-color: #d9ead3;">156,00</td> </tr> <tr> <td>€/m</td> <td style="background-color: #d9ead3;">61,50</td> <td style="background-color: #d9ead3;">97,00</td> </tr> </table>	€/Piece	156,00	156,00	€/m	61,50	97,00
€/Piece	156,00	156,00							
€/m	61,50	97,00							
	505	Standard preparation per frame plus Linear meter profile	<table border="0"> <tr> <td>€/Piece</td> <td style="background-color: #d9ead3;">203,00</td> <td style="background-color: #d9ead3;">203,00</td> </tr> <tr> <td>€/m</td> <td style="background-color: #d9ead3;">58,50</td> <td style="background-color: #d9ead3;">87,50</td> </tr> </table>	€/Piece	203,00	203,00	€/m	58,50	87,50
€/Piece	203,00	203,00							
€/m	58,50	87,50							
	506*	Standard preparation per frame plus Linear meter profile	<table border="0"> <tr> <td>€/Piece</td> <td style="background-color: #d9ead3;">256,00</td> <td style="background-color: #d9ead3;">256,00</td> </tr> <tr> <td>€/m</td> <td style="background-color: #d9ead3;">58,50</td> <td style="background-color: #d9ead3;">87,50</td> </tr> </table>	€/Piece	256,00	256,00	€/m	58,50	87,50
€/Piece	256,00	256,00							
€/m	58,50	87,50							

For enquiries / orders please use the attached form.

\* Please note when ordering fittings: With these frame types, three hinges are required.

## Pre-assembled door frame elements

AL	AL
silver EV1	sim satin
anod (101)	stainl steel
	anod C31
	(113)

Frame type	Description
------------	-------------

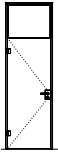
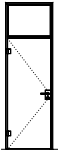
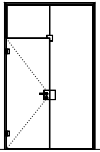
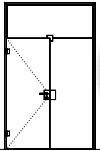
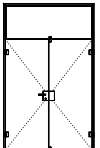
	<b>507</b>		Standard preparation per frame plus Linear meter profile	€/Piece	<b>162,00</b>	<b>162,00</b>
				€/m	<b>60,00</b>	<b>91,00</b>
	<b>507S</b>	with Georgian bar profile	Standard preparation per frame plus Linear meter profile	€/Piece	on request	on request
				€/m	on request	on request
	<b>508</b>		Standard preparation per frame plus Linear meter profile	€/Piece	on request	on request
				€/m	on request	on request
	<b>509</b>		Standard preparation per frame plus Linear meter profile	€/Piece	on request	on request
				€/m	on request	on request
	<b>510</b>		Standard preparation per frame plus Linear meter profile	€/Piece	<b>191,00</b>	<b>191,00</b>
				€/m	<b>60,00</b>	<b>91,00</b>

For enquiries / orders please use the attached form.

Single components

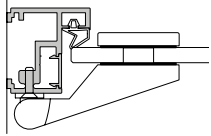

Base parts (000) AL silver EV1 anod (101) AL sim satin stainl steel anod C31 (113)

Art. No. Description

Matching with all DORMA fittings for rebate depth of 24 mm.

All ALEXA AT 44 frame types are compatible with locks in the following design:

- STUDIO Rondo
- STUDIO Classic
- STUDIO Gala 2.0
- STUDIO Arcos
- STUDIO Medio
- OFFICE Junior
- OFFICE Classic
- OFFICE Arcos

Single action

	<b>32.015</b> ALEXA AT 44 frame profile drilled with template stock length 5500 mm	€/m	41,50	65,50
	<b>32.018</b> ALEXA AT 44 clips profile stock length 5500 mm	€/m	8,70	11,50
	<b>32.019</b> ALEXA AT 44 glass edging profile for fixed panels (overpanel or side panel) stock length 6000 mm	€/m	9,10	16,50
	<b>32.025</b> Rubber strike profile for ALEXA AT 44 + AT 50 frame profile 8 mm glass stock length 12 m (on a roll)	€/m	4,10	
	<b>32.027</b> Rubber strike profile for ALEXA AT 44 + AT 50 frame profile 10 mm glass stock length 12 m (on a roll)	€/m	4,10	
	<b>32.021</b> Compensating profile PVC for ALEXA AT 44 for fixed glass panels 8 mm glass stock length 25 m (on a roll)	€/m	6,50	
	<b>32.023</b> Compensating profile PVC for ALEXA AT 44 for fixed glass panels 10 mm glass stock length 25 m (on a roll)	€/m	5,80	
	<b>07.253</b> Glass wedge profile PVC for ALEXA AT 44, for fixed glass panels 8 and 10 mm glass stock length 50 m (on a roll)	€/m	3,00	
	<b>32.035</b> ALEXA AT 44 corner connector bracket (set of 2)	€/Set	19,00	
	<b>32.029</b> ALEXA AT 44 overpanel fixing bracket LH	€/Piece	10,00	10,50
	<b>32.030</b> ALEXA AT 44 overpanel fixing bracket RH	€/Piece	10,00	10,50



## Single components

Base parts (000) AL silver EV1 anod (101) AL sim satin stainl steel anod C31 (113)

**Art. No.**   **Description**

**32.037** Screws for hinges M4 x 16, stainless steel for ALEXA AT 44 + AT 50 frame profile (set of 100) €/Set **12,50**



**32.031** ALEXA AT 44 + AT 50 aluminium film pad, self-adhesive, for frame portions €/Piece **1,00**



**10.407** Screw-on frame portion Studio incl. pin €/Piece **11,00**



**11.405** Screw-on frame portion Office €/Piece **11,50**

ALEXA  
fix  
Glass  
Premium Glass Hardware

# ALEXA AT 50

Single action



Technical data	
Glass	TSG
Glass thickness	8, 10 mm
Max. door weight	45 - 65 kg (depending on hinge type)
Material	Aluminium
Standard finishes	Anodised colors
Specials	Customized and pre-assembled door frames. Alternative: Single parts in stock lengths for maximum flexibility

## Manual single action door systems

### STUDIO

182	STUDIO Rondo
190	STUDIO Classic
196	STUDIO Gala 2.0
202	STUDIO Arcos
210	STUDIO Medio

### OFFICE

214	OFFICE Junior
220	OFFICE Classic
226	OFFICE Arcos

### 232 Special hinges

### 236 PORTEO

### ALEXA door frames

240	AT 23 / AT 23E
244	AT 44
250	AT 50 with AT 44 / AT 50 with MR 28
256	Order form

### General accessories for the single action door range

258	Frame pivots for internal doors
260	Frame pockets, push-on sleeves, strike plates
262	Door rails for internal doors
266	Floor bearings, profile cylinders, door bolts, door catches, floor sockets
270	Door closers, door closer accessories

### Section drawings

ALEXA AT 50 with AT 44

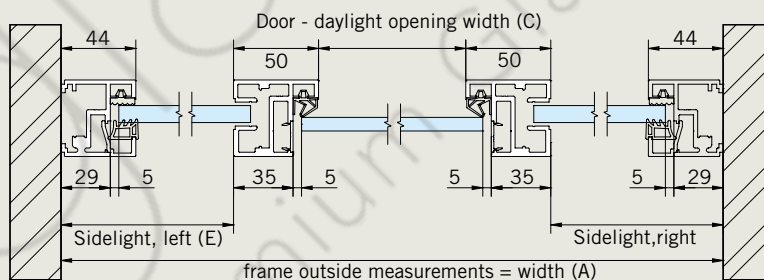

ALEXA AT 50 with MR 28

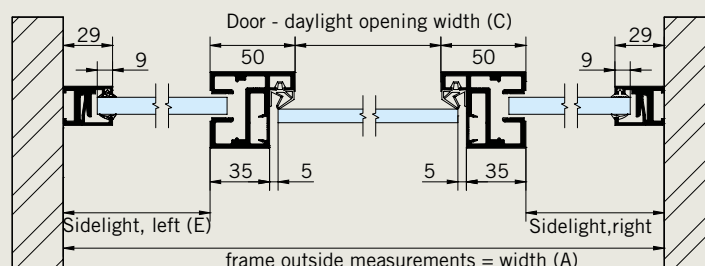

Pre-assembled door frame elements

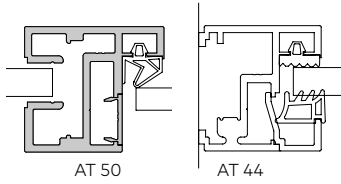

AL	AL
silver EV1	sim satin
anod	stainl steel
(101)	anod C31
	(113)

Frame type Description

**Frames:**

Included in the price and scope of supply are, depending on system type, all made-to-measure frame profiles, glass edging profiles, strike and sealing profiles, screw-on frame portions, corner connectors and all necessary tapped holes and screws.

Matching with all DORMA fittings for rebate depth of 24 mm.

All ALEXA AT 50 frame types in combination with AT 44 are compatible with locks in the following design:

- |                 |                |
|-----------------|----------------|
| STUDIO Rondo    | OFFICE Junior  |
| STUDIO Classic  | OFFICE Classic |
| STUDIO Gala 2.0 | OFFICE Arcos   |
| STUDIO Arcos    |                |
| STUDIO Medio    |                |

Single action

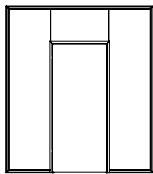

550 / 44

Standard preparation per assembly	€/Piece	329,00	329,00
plus			
Linear meter profile AT 50	€/m	70,50	103,00
plus			
Linear meter profile AT 44	€/m	63,00	97,50

For enquiries / orders please use the attached form.

\* Please note when ordering fittings: With these frame types, three hinges are required.

## Single components

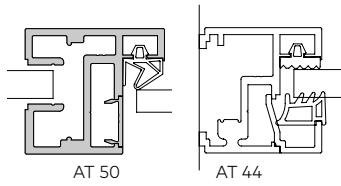

Base parts (000)	AL silver EV1 anod (101)	AL sim satin stainl steel anod C31 (113)
------------------	--------------------------	--











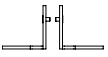

Art. No. Description

Matching with all DORMA fittings for rebate depth of 24 mm.

All ALEXA AT 50 frame types in combination with AT 44 are compatible with locks in the following design:

STUDIO Rondo  
STUDIO Classic  
STUDIO Gala 2.0  
STUDIO Arcos  
STUDIO Medio

OFFICE Junior  
OFFICE Classic  
OFFICE Arcos

	<b>32.050</b>	ALEXA AT 50 frame profile stock length 5500 mm	€/m	53,50	80,00
	<b>32.018</b>	ALEXA AT 44 clips profile stock length 5500 mm	€/m	8,70	11,50
	<b>32.051</b>	ALEXA AT 50 corner connector bracket (set of 2)	€/Set	19,50	
	<b>32.052</b>	ALEXA AT 50 floor support bracket for combination with AT 44 set (LH/RH)	€/Set	29,00	
	<b>32.025</b>	Rubber strike profile for ALEXA AT 44 + AT 50 frame profile 8 mm glass stock length 20 m (on a roll)	€/m	4,10	
	<b>32.027</b>	Rubber strike profile for ALEXA AT 44 + AT 50 frame profile 10 mm glass stock length 20 m (on a roll)	€/m	4,10	
	<b>32.015</b>	ALEXA AT 44 frame profile drilled with template stock length 5500 mm	€/m	41,50	65,50
	<b>32.019</b>	ALEXA AT 44 glass edging profile for fixed panels (overpanel or side panel) stock length 5500 mm	€/m	9,10	16,50
	<b>32.054</b>	Glass wedge profile PVC for ALEXA AT 44 / AT 50 for 10 mm glass stock length 25 m (on a roll)	€/m	5,20	
	<b>32.056</b>	Compensating profile PVC for fixed glass in ALEXA AT 44 / AT 50 8 and 10 mm glass stock length 25 m (on a roll)	€/m	4,90	
	<b>32.037</b>	Screws for hinges M4 x 16, stainless steel for ALEXA AT 44 or MR 28 + AT 50 frame profile (set of 100)	€/Set	12,50	
	<b>32.031</b>	ALEXA AT 44 + AT 50 aluminium film pad, self-adhesive, for frame portions	€/Piece	1,00	
	<b>10.407</b>	Screw-on frame portion Studio, incl. pin	€/Piece	11,00	
	<b>11.405</b>	Screw-on frame portion Office	€/Piece	11,50	

Pre-assembled door frame elements

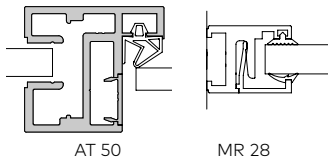

AL silver EV1 anod (101) AL sim satin stainl steel anod C31 (113)

Frame type Description

**Frames:**

Included in the price and scope of supply are, depending on system type, all made-to-measure frame profiles, glass edging profiles, strike and sealing profiles, screw-on frame portions, corner connectors and all necessary tapped holes and screws.

Matching with all DORMA fittings for rebate depth of 24 mm.

All ALEXA AT 50 frame types in combination with MR 28 are compatible with locks in the following design:

- |                 |                |
|-----------------|----------------|
| STUDIO Rondo    | OFFICE Junior  |
| STUDIO Classic  | OFFICE Classic |
| STUDIO Gala 2.0 | OFFICE Arcos   |
| STUDIO Arcos    |                |
| STUDIO Medio    |                |

Single action

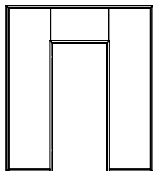

550 / 28

Standard preparation per frame	€/Piece	329,00	329,00
plus			
Linear meter profile AT 50	€/m	70,50	103,00
plus			
Linear meter profile MR 28	€/m	41,00	52,50

For enquiries / orders please use the attached form.

\* Please note when ordering fittings: With these frame types, three hinges are required.

## Single components

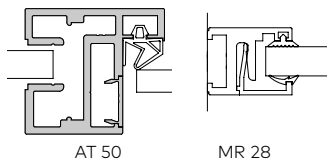

AT 50

MR 28

Base parts (000)	AL silver EV1 anod (101)	AL sim satin stain steel anod C31 (113)
------------------	--------------------------	---

**Art. No. Description**

Matching with all DORMA fittings for rebate depth of 24 mm.

All ALEXA AT 50 frame types in combination with MR 28 are compatible with locks in the following design:

STUDIO Rondo  
STUDIO Classic  
STUDIO Gala 2.0  
STUDIO Arcos  
STUDIO Medio

OFFICE Junior  
OFFICE Classic  
OFFICE Arcos

	<b>32.050</b>	ALEXA AT 50 frame profile stock length 5500 mm	€/m	53,50	80,00
	<b>32.018</b>	ALEXA AT 44 clips profile stock length 5500 mm	€/m	8,70	11,50
	<b>32.051</b>	ALEXA AT 50 corner connector bracket (set of 2)	€/Set	19,50	
	<b>32.053</b>	ALEXA AT 50 floor support bracket for combination with MR 28 set (LH / RH)	€/Set	29,00	
	<b>32.025</b>	Rubber strike profile for ALEXA AT 44 + AT 50 frame profile 8 mm glass stock length 20 m (on a roll)	€/m	4,10	
	<b>32.027</b>	Rubber strike profile for ALEXA AT 44 + AT 50 frame profile 10 mm glass stock length 20 m (on a roll)	€/m	4,10	
	<b>32.037</b>	Screws for hinges M4 x 16, stainless steel for ALEXA AT 44 or MR 28 + AT 50 frame profile (set of 100)	€/Set	12,50	
	<b>32.031</b>	ALEXA AT 44 + AT 50 aluminium film pad, self-adhesive, for frame portions	€/Piece	1,00	
	<b>10.407</b>	Screw-on frame portion Studio, incl. pin	€/Piece	11,00	
	<b>11.405</b>	Screw-on frame portion Office	€/Piece	11,50	

**Order form**

Single action

Enquiry  Order

Sender's address/Stamp

Delivery address

eMail address

Purchase order number / project / reference:

Contact name/Phone extension:

Type of technical drawing per eMail:  DWG  PDF

ALEXA system:  AT 23  AT 23E  AT 44  AT 50/AT 44  AT 50/MR 28 Frame type no.: \_\_\_\_\_ Finish code (e.g. 000): \_\_\_\_\_

Quantity of systems: \_\_\_\_\_

Opening direction:  LH  RH Glass thickness:  8 mm  10 mm Fittings/accessories in order included:  yes  no

**Attention: please always indicate type of hinge, type of lock and accessories!**

Type of hinge: \_\_\_\_\_ Quantity: \_\_\_\_\_ Art. No.: \_\_\_\_\_ Finish code (e.g. 000): \_\_\_\_\_  
e.g. STUDIO Rondo

Type of lock: \_\_\_\_\_ Quantity: \_\_\_\_\_ Art. No.: \_\_\_\_\_ Finish code (e.g. 000): \_\_\_\_\_  
e.g. STUDIO Rondo

Accessories: \_\_\_\_\_ Quantity: \_\_\_\_\_ Art. No.: \_\_\_\_\_ Finish code (e.g. 000): \_\_\_\_\_  
e.g. STUDIO Rondo

**Indication of measurements:**

Clear installation width (frame outside measurement): \_\_\_\_\_ mm

Clear installation height (frame outside measurement): \_\_\_\_\_ mm

**Door assemblies with overpanel and/or fixed sidelight:**

Clear door width: \_\_\_\_\_ mm

Clear door height: \_\_\_\_\_ mm

Notes:



Notes





Single action

Frame pivots for STUDIO Rondo / Classic / Gala / Arcos

Base parts (000)













Single action

Art. No.	Description	€/Piece
 10.424	Frame pivot for wooden frames / STUDIO	5,00
 10.423	Frame pivot for steel frames / STUDIO	3,70
 10.407	Screw-on frame pivot / STUDIO	12,00



## Frame pivots for OFFICE Junior / Classic / Arcos

Base  
parts  
(000)



	Art. No.	Description	€/Piece
	11.310	Frame pivot for wooden frames / OFFICE	5,10
	11.236	Frame pivot for wooden frames / OFFICE, prepared for ball bearing	11,50
	11.309	Frame pivot for steel frames / OFFICE	3,70
	11.235	Frame pivot for steel frames / OFFICE, prepared for ball bearing	10,00
	11.307	Frame pivot stainless steel, for steel frames	14,00
	11.405	Screw-on frame pivot / OFFICE not usable with Art. No. 11.230 with finish satin stainless steel (700)	11,50
	11.406	Screw-on frame pivot / OFFICE, prepared for ball bearing not usable with Art. No. 11.230 - 11.234 with finish satin stainless steel (700)	16,00
	11.308	Frame pivot for 120 mm frame pocket	7,40
	11.248	Frame pivot prepared for ball bearing for 120 mm frame pocket	12,50
	11.304	Frame pivot stainless steel for VX-frame pocket	17,00
	11.305	Frame pivot stainless steel for VX-frame pocket, prepared for ball bearing	19,50
	11.249	Frame pivot stainless steel for 160 mm frame pocket	16,50

Single action

Accessories for internal doors

Single action

Base parts (000) AL silver anod (150) AL traffic white p-coat (300) AL silver brilliant anod (103) AL niro anod (157) AL brass brilliant anod (106) AL special color anod (199) AL special color p-coat (399)

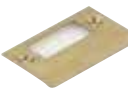
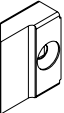
Art. No.	Description	€/Piece	€/Piece	€/Piece	€/Piece	€/Piece	€/Piece	€/Piece	€/Piece	
<b>Frame pockets</b>										
	10.405	Frame pocket for wooden frames	3,70							
	10.406	Frame pocket for steel frames	3,70							
<b>Push-on sleeves</b>										
	10.408	Push-on sleeve for STUDIO	3,70	3,70		5,00		5,00	5,00	
	11.311	Push-on sleeve for OFFICE	3,70	3,70		3,70		5,10	5,10	
<b>Strike plates</b>										
	10.401	Corner strike plate, aluminium for 24 mm rebate depth for STUDIO	8,80	8,80	10,00	14,00	15,00	16,00	16,00	
	10.411	do. but with 16 mm side piece	8,80	9,20	10,00	14,50	15,50			
	10.421	Strike plate, stainless steel for 40 mm rebate depth for STUDIO	6,20							
	10.422	Strike plate, brass for 40 mm rebate depth for STUDIO	6,20							
	11.313	Corner strike plate, aluminium for 24 mm rebate depth for OFFICE	19,50							
										brass satin nickel-plated (101)
<b>Special single latch STUDIO</b>										
	10.066	Single latch for Austrian norm frames and for the combination of 10 mm glass with a 24 mm rebate depth. Usable for STUDIO Rondo, Classic, Gala and Arcos	8,80							

## Accessories for internal doors

AL  
silver EV1  
anod  
(101)

Art. No.	Description	€/Piece
<b>Barrier free door stopper – Easy Stop</b>		
	<b>10.591</b> Easy Stop for single action doors, for 8 mm glass. Stainless steel adapter to glue onto glass (UV-gluing) with plastic cap	<b>139,00</b>

glass  
Premium Glass Hardware

fix

Single action

Accessories for internal doors

AL silver EV1 anod (101) AL sim satin stainl steel anod (107)

Single action

Art. No.	Description	€/Piece	€/Piece
<b>DORMA Planet door rail with automatic seal for 8 mm glass thickness KG-D8</b>			
	12.230 834 mm	148,00	178,00
	12.235 959 mm	153,00	187,00
	12.245 1084 mm	157,00	189,00
	12.240 1209 mm	160,00	191,00
<b>DORMA Planet door rail with automatic seal for 10 mm glass thickness KG-D10</b>			
	12.231 834 mm	148,00	178,00
	12.236 959 mm	153,00	187,00
	12.246 1084 mm	157,00	189,00
	12.241 1209 mm	160,00	191,00
<b>DORMA Planet door rail with automatic seal for side fixing resp. retrofitting KG-S</b>			
	12.232 834 mm	148,00	178,00
	12.237 959 mm	153,00	187,00
	12.247 1085 mm	157,00	189,00
	12.242 1209 mm	160,00	191,00
<b>DORMA Planet door rail with automatic seal for adhesion under door leaf, KG-U</b>			
	12.233 834 mm	148,00	178,00
	12.238 959 mm	153,00	187,00
	12.248 1084 mm	157,00	189,00
	12.243 1209 mm	160,00	191,00
<b>DORMA Planet door rail with automatic seal for retrofitting KG-SM (for easy sticking with provided double-sided adhesive strip)</b>			
	12.234 834 mm	133,00	157,00
	12.239 959 mm	136,00	166,00
	12.249 1084 mm	157,00	176,00
	additional charge for cut by saw DORMA Planet (on request) (Maximum shortage 125 mm.)	6,20	6,20

## Accessories for internal doors

Art. No.	Description	Base parts (000)	AL silver anod (150)	AL niro anod (157)	AL special color anod (199)	AL special color p-coat (399)
<b>Door rails with pair of plastic end caps, for 8 mm glass thickness</b>						
	<b>12.102</b> Standard length 834 mm	41,50	58,50	67,00	67,00	
	<b>12.103</b> Standard length 959 mm	46,00	65,50	74,50	74,50	
	<b>12.104</b> Stock length 1200 mm	54,00	70,50	86,50	86,50	
	<b>12.100</b> Fixed length up to 1200 mm	57,00	73,50	90,50	90,50	
<b>Door rails with pair of plastic end caps, for 10 mm glass thickness</b>						
	<b>12.122</b> Standard length 834 mm	46,00	65,50	73,50	73,50	
	<b>12.123</b> Standard length 959 mm	52,00	72,00	82,00	82,00	
	<b>12.124</b> Stock length 1200 mm	59,50	77,50	94,50	94,50	
	<b>12.120</b> Fixed length up to 1200 mm	62,50	81,00	98,00	98,00	
<b>Brush seals for door rails</b>						
	<b>12.115</b> Stock length 1000 mm	17,50				
	<b>12.110</b> Stock length 2000 mm	36,00				
	<b>12.116</b> Fixed length up to 1000 mm	21,00				
	<b>12.111</b> Fixed length 1001 - 1200 mm	25,50				
<b>Plastic end cap for door rails for 8 mm glass thickness</b>						
	<b>12.106</b> Plastic end cap for door rail, black	3,90				
	<b>12.107</b> Plastic end cap for door rail, white	3,90				
<b>Plastic end cap for door rails for 10 mm glass thickness</b>						
	<b>12.108</b> Plastic end cap for door rail, black	3,90				
	<b>12.109</b> Plastic end cap for door rail, white	3,90				

Accessories for internal doors

AL silver anod (150)	AL niro anod (157)	AL special color anod (199)	AL special color p-coat (399)
----------------------	--------------------	-----------------------------	-------------------------------

Art. No.	Description	€/Piece	€/Piece	€/Piece	€/Piece	
<b>Door rails with PVC draught strip for 8 mm glass thickness</b>						
	<b>12.202</b> Standard length 834 mm	- LH	153,00	184,00	200,00	200,00
	<b>12.203</b> do.	- RH	153,00	184,00	200,00	200,00
	<b>12.204</b> Standard length 959 mm	- LH	156,00	191,00	212,00	212,00
	<b>12.205</b> do.	- RH	156,00	191,00	212,00	212,00
	<b>12.200</b> Fixed length up to 1200 mm	- LH	165,00	197,00	220,00	220,00
	<b>12.201</b> do.	- RH	165,00	197,00	220,00	220,00
<b>Door rails with PVC draught strip for 10 mm glass thickness</b>						
	<b>12.212</b> Standard length 834 mm	- LH	153,00	186,00	200,00	200,00
	<b>12.213</b> do.	- RH	153,00	186,00	200,00	200,00
	<b>12.214</b> Standard length 959 mm	- LH	159,00	191,00	212,00	212,00
	<b>12.215</b> do.	- RH	159,00	191,00	212,00	212,00
	<b>12.210</b> Fixed length up to 1200 mm	- LH	165,00	197,00	220,00	220,00
	<b>12.211</b> do.	- RH	165,00	197,00	220,00	220,00

Single action

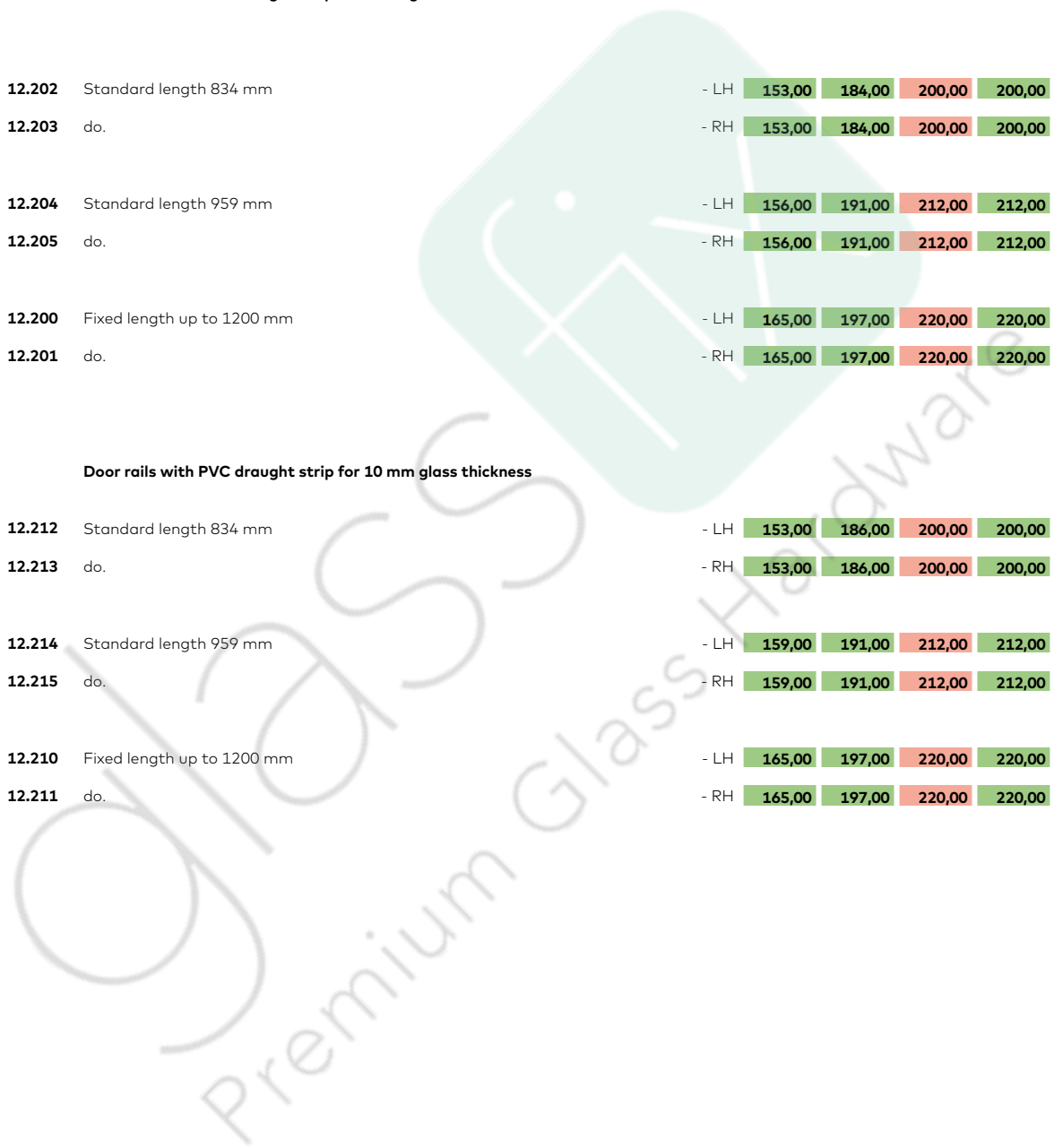







**Notes**



Single action

Floor bearings

Base parts (000)	AL silver EV1 anod (101)	AL traffic white p-coat (300)	Polish stainl steel (701)	Satin stainl steel (700)	AL special color anod (199)	AL special color p-coat (399)
------------------	--------------------------	-------------------------------	---------------------------	--------------------------	-----------------------------	-------------------------------

Art. No.	Description	€/Piece	€/Piece	€/Piece	€/Piece	€/Piece	€/Piece
07.624	<b>Torque wrench calibrated to 12 Nm,</b> (adjustable 3,2 – 16 Nm)	net price		<b>91,00</b>			
	<b>Floor bearing</b>						
	01.106 Floor pivot bearing with round pivot (stainless steel) and cover plate	47,00	47,00	56,00	51,00	59,50	59,50
	01.107 Floor bearing	26,00					
	04.602 Floor pivot bearing with flat tapered spindle	65,50					
	04.770 do., but 2,5 mm enhanced spindle	76,00					
	04.771 do., but 5 mm enhanced spindle	76,00					
	04.772 do., but 10 mm enhanced spindle	76,00					
	04.773 do., but 15 mm enhanced spindle	76,00					
	04.774 do., but 20 mm enhanced spindle	76,00					
	04.603 Floor bearing with flat tapered spindle version stainless steel	158,00					
	01.136 <b>Screw-on floor bearing moistureproof,</b> compl. with insert for door rails, max. 100 kg	58,50					

Single action

**Lock keeper plates, floor sockets, profile cylinders, pull handle fixings**

Art. No.	Description	Base parts (000)	AL silver anod (150)	AL special color anod (199)	AL special color p-coat (399)
		€/Piece	€/Piece	€/Piece	€/Piece
	<b>05.190</b> Lock keeper plate, stainless steel, adjustable	13,50			
	<b>05.192</b> Floor socket	7,00			
	<b>05.193</b> Floor socket, dirt protection	14,50			
	<b>05.194</b> Eccentric socket, adjustable	23,00			
	<b>13.001</b> Single pull handle fixing	28,00	47,00	47,00	
	<b>13.002</b> Back to back pull handle fixing	33,50	55,00	55,00	
	<b>05.001</b> Profile cylinder, length 61 mm long, differently keyed, with DORMA Logo	19,00			
	<b>05.002</b> do., equally keyed	24,50			
	<b>05.003</b> Half profile cylinder length, 31 mm differently keyed, with DORMA Logo	19,00			
	<b>05.004</b> do., equally keyed	23,50			

Single action

Thumbturn cylinders, door bolts, door catch

Single action

Base parts (000) AL silver anod (150) AL traffic white p-coat (300) AL niro anod (157) AL silver brilliant anod (103) AL brass brilliant anod (106) AL special color anod (199) AL special color p-coat (399)

Art. No.	Description	€/Piece	€/Piece	€/Piece	€/Piece	€/Piece	€/Piece	€/Piece	€/Piece
	<b>10.310</b> Thumbturn cylinder		Brass point. silver <b>46,50</b>		Brass point. steel <b>73,50</b>				<b>84,50</b>
	<b>10.311</b> Thumbturn half-cylinder		Brass point. silver <b>44,50</b>		Brass point. steel <b>58,50</b>				<b>68,50</b>
	<b>12.301</b> Slide-on door bolt for 8 mm glass thickness		<b>41,50</b>	<b>41,50</b>	<b>62,50</b>	<b>65,50</b>	<b>65,50</b>	<b>73,50</b>	<b>73,50</b>
	<b>12.314</b> Slide-on strike-box for 12.301 for 8 mm glass thickness		<b>41,50</b>		<b>62,50</b>			<b>73,50</b>	<b>73,50</b>
	<b>12.302</b> Slide-on door bolt for 10 mm glass thickness		<b>42,50</b>	<b>42,50</b>	<b>64,00</b>		<b>67,00</b>	<b>74,50</b>	<b>74,50</b>
	<b>12.317</b> Slide-on strike-box for 12.302 for 10 mm glass thickness		<b>42,50</b>		<b>59,00</b>			<b>74,50</b>	<b>74,50</b>
	<b>12.312</b> Door bolt on glass holes for 8 mm glass thickness		<b>41,50</b>	<b>41,50</b>	<b>62,50</b>			<b>73,50</b>	<b>73,50</b>
	<b>12.313</b> Strike-box on glass holes for 12.312 for 8 mm glass thickness		<b>41,50</b>		<b>62,50</b>			<b>73,50</b>	<b>73,50</b>
	<b>12.315</b> Door bolt on glass holes for 10 mm glass thickness		<b>42,50</b>	<b>42,50</b>	<b>64,00</b>			<b>74,50</b>	<b>74,50</b>
	<b>12.318</b> Door bolt with free glass edge, on glass holes for 8 and 10 mm glass thickness		<b>41,50</b>	<b>41,50</b>	<b>58,00</b>			<b>71,00</b>	<b>71,00</b>
	<b>12.316</b> Strike-box on glass holes for 12.315 for 10 mm glass thickness		<b>42,50</b>		<b>64,00</b>			<b>74,50</b>	<b>74,50</b>
	<b>12.300</b> Door catch, plastic		<b>14,50</b>						
	<b>12.305</b> Door catch with round bolt		<b>14,50</b>						

**Notes**



Single action

Door closer sets

AL     Satin  
silver EV1     stainl  
anod     steel  
(101)     (700)

Single action





Art. No.	Description	€/Piece	€/Piece
<b>TS 97, BTS 75V, BTS 80, BTS 84</b>			
<b>18.070</b>	<b>TS 97 incl. saddle plate (slide-over bracket) and mechanical hold-open</b> comprising: 13010001 TS 97 EN 2-4 with slide channel 13000201 Saddle plate for TS 97 13000100 Hold-open for TS 97	X	
<b>18.071</b>	<b>BTS 75V set with 90° hold-open, flat tapered spindle insert and stainless steel cover,</b> comprising: 61701200 BTS 75V with bridge fixing, with spindle insert (flat tapered), including cement box, with backcheck, with constant 90° hold-open 46700059 BTS 75V stainless steel cover		X
<b>18.072</b>	<b>BTS 75V set without hold-open, with flat tapered spindle insert and stainless steel cover,</b> comprising: 61701000 BTS 75V with bridge fixing, with spindle insert (flat tapered), including cement box, with backcheck, without hold-open 46700059 BTS 75V stainless steel cover		X
<b>18.073</b>	<b>BTS 80 set, EN3, with adjustable hold-open, flat tapered spindle insert and stainless steel cover,</b> comprising: 8012000 BTS 80 with cement box, spindle insert (flat tapered), standard design with variable hydraulic hold-open (with on/off switch), or delayed action (adjustable), backcheck, EN3 46700000 Universal BTS 80 stainless steel cover		X
<b>18.074</b>	<b>BTS 80 set, EN4, with adjustable hold-open, flat tapered spindle insert and stainless steel cover,</b> comprising: 8011000 BTS 80 with cement box, spindle insert (flat tapered), standard design with variable hydraulic hold-open (with on/off switch), or delayed action (adjustable), backcheck, EN4 46700000 Universal BTS 80 stainless steel cover		X
<b>18.075</b>	<b>BTS 84 set, EN3, without adjustable hold-open, with flat tapered spindle insert and stainless steel cover,</b> comprising: 81110002 BTS 84, EN3, with spindle insert 467000022 BTS 84 stainless steel cover		X
<b>18.076</b>	<b>BTS 84 set, EN4, without adjustable hold-open, with flat tapered spindle insert and stainless steel cover,</b> comprising: 81100002 BTS 84, EN4, with spindle insert 467000022 BTS 84 stainless steel cover		X
<b>18.077</b>	<b>BTS 84 EN3, with 90° hold-open, flat tapered spindle insert and stainless steel cover,</b> comprising: 81210002 BTS 84, EN3, 90° hold-open, with spindle insert 467000022 BTS 84 stainless steel cover		X
<b>18.078</b>	<b>BTS 84 EN4, with 90° hold-open, flat tapered spindle insert and stainless steel cover,</b> comprising: 81200002 BTS 84, EN4, 90° hold-open, with spindle insert 467000022 BTS 84 stainless steel cover		X

X = Prices on application

## Accessories for upper door closer

AL  
silver  
anod  
(150)

AL  
special  
color  
p-coat  
(399)

Art. No.	Description	€/Piece	€/Piece
	<b>12.330</b> Fixing plate for TS 73 V, closer arm for overpanel	13,50	18,00
	<b>12.331</b> Fixing plate 233 mm for TS 73 V with manufacturing date by August 2006	44,00	54,00
	<b>12.335</b> Fixing plate 223 mm for TS 73 V	44,00	54,00
	<b>12.332</b> Fixing plate for TS 92 slide channel for overpanel	44,00	54,00
	<b>12.334</b> Fixing plate 279 mm for TS 92	44,00	54,00

Single action

# TENSOR

Double action



Technical data	
Glass	TSG
Glass thickness	8, 10, 12 mm
Max. door weight	65 kg
Applications	1-/2 panels, sidelight
Material	Aluminium
Finishes	Anodised colors
Specials	Closing function without additional fitting element, hold open at 90° opening angle certificate of 500,000 operating cycles



## Manual double action door systems

272 TENSOR

276 VISUR

280 RP - Frame profile with transom door closer

General accessories for double action doors

376 Centre and corner locks, strike boxes

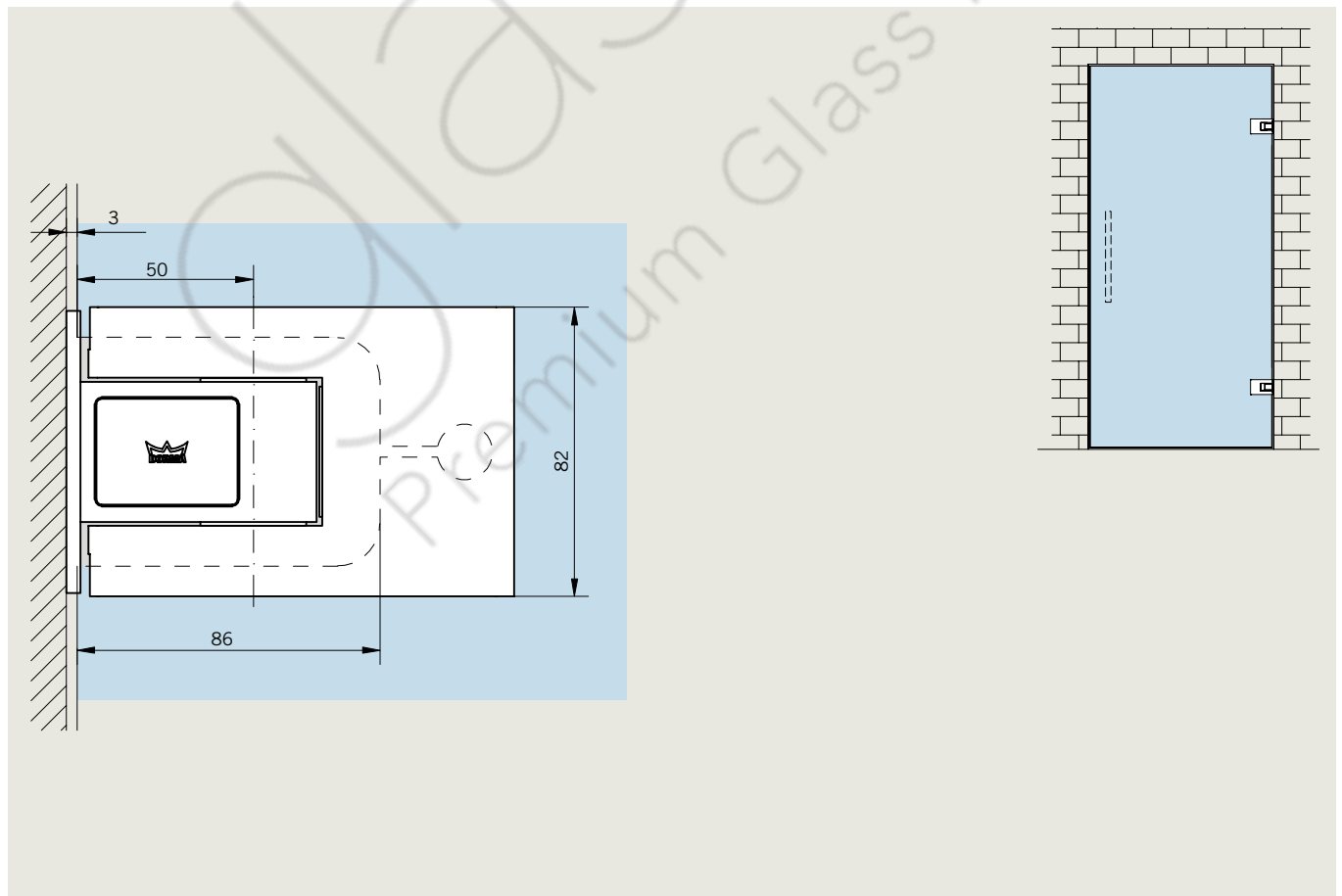

Example view for TENSOR



Double action

Complete sets

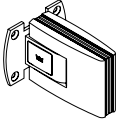
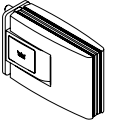
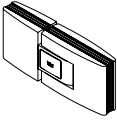
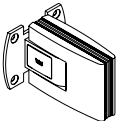
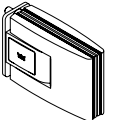
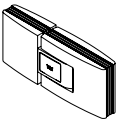

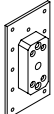



Base parts (000) AL EV1-Deco anod (114) AL sim satin stainl steel C31 anod (113)

Art. No.	Description	€/Pair	€/Pair	€/Pair
	<b>12.527</b> TENSOR – Pair of double action hinges incl. mounting plate, round; for installation onto wall or frame with surface mounted mounting plate, incl. 2 floor doorstops (Art. No. 29.950)		504,00	515,00
	<b>12.528</b> TENSOR – Pair of double action hinges incl. mounting plate; for installation into frame with embedded mounting plate incl. 2 floor doorstops (Art. No. 29.950)		483,00	490,00
	<b>12.529</b> TENSOR – Pair of double action hinges for installation glass to glass incl. 2 floor doorstops (Art. No. 29.950)		652,00	672,00
	<b>Single components</b>			
	<b>12.520</b> TENSOR – Pair of double action hinges incl. mounting plate, round; for installation onto wall or frame with surface mounted mounting plate		471,00	482,00
	<b>12.522</b> TENSOR – Pair of double action hinges incl. mounting plate; for installation into frame with embedded mounting plate		449,00	457,00
	<b>12.523</b> TENSOR – Pair of double action hinges for installation glass to glass		618,00	640,00
	<b>12.536</b> Overpanel-sidepanel connector		€/Piece 36,50	€/Piece 43,50
	<b>12.526</b> Embedded mounting plate		70,50	

Double action

Single components

AL Satin  
silver EV1 stain  
anod steel  
(101) (700)

Art. No.	Description	€/Piece	€/Piece
<b>Barrier free door stop – Easy Stop</b>			
	<b>10.592</b> Easy Stop for double action doors – for 8 mm glass stainless steel adapter to glue onto glass, plastic cap	235,00	
	<b>10.593</b> Easy Stop for double action doors – for 10 mm glass stainless steel adapter to glue onto glass, plastic cap	235,00	
	<b>10.594</b> Easy Stop for double action doors – for 12 mm glass stainless steel adapter to glue onto glass, plastic cap	235,00	
	<b>29.950</b> Floor doorstop	32,50	
	<b>29.951</b> Wall doorstop, short	31,00	
	<b>29.952</b> Wall doorstop, long	35,50	

Double action

# VISUR

Double action



Technical data	
Glass	TSG
Glass thickness	10, 12 mm
Max. door weight	85 kg
Applications	1-/2 panels, sidelight
Material	Aluminium
Finishes	Anodised colors
Specials	Invisible glass fixing, Installation without door frame, Patented fitting system

## Manual double action door systems

272 TENSOR

276 VISUR

280 RP - Frame profile with transom door closer

### General accessories for double action doors

376 Centre and corner locks, strike boxes

Example view for VISUR

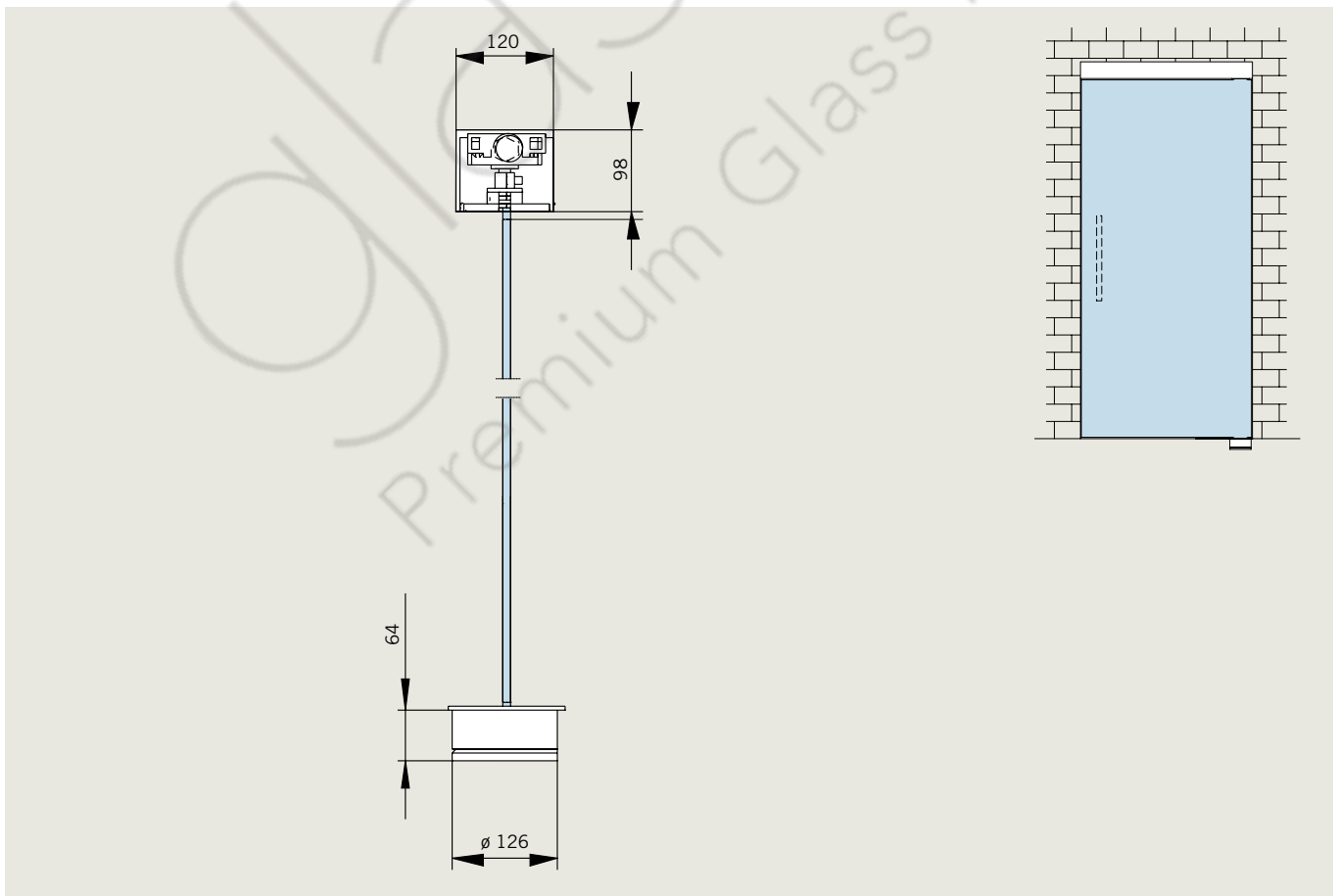

Complete sets

AL  
EV1-Deco  
anod  
(114)

Art. No. Description

€/Piece

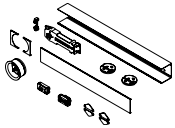

**03.770 VISUR complete set for single leaf doors**  
incl. transom tube, RTS 85,  
top and bottom pivot  
(please indicate clear width in mm)

789,00

**03.771 VISUR complete set for double leaf doors**  
incl. transom tube, RTS 85,  
top and bottom pivot  
(please indicate clear width in mm)

1578,00

**03.790 VISUR complete set for single leaf doors with one side panel\***,  
incl. transom tube, RTS 85,  
top and bottom pivot  
(please indicate clear width, door width and side panel width in mm,  
please indicate position of the side panel)

877,00

**03.791 VISUR complete set for single leaf doors with two side panels\***,  
incl. transom tube, RTS 85,  
top and bottom pivot  
(please indicate clear width, door width and side panels widths in mm,  
please indicate position of the side panels)

965,00

**03.792 VISUR complete set f. double leaf doors with one side panel\***,  
incl. transom tube, RTS 85,  
top and bottom pivot  
(please indicate clear width, doors widths and side panel width in mm,  
please indicate position of the side panel)

1666,00

**03.793 VISUR complete set f. double leaf doors with two side panels\***,  
incl. transom tube, RTS 85,  
top and bottom pivot  
(please indicate clear width, doors widths and side panels widths in mm,  
please indicate position of the side panels)

1753,00







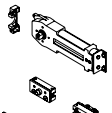

\* side panel max. 1000 mm,  
when exceeding 1000 mm price on request

Double action

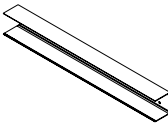
## Sets and single components

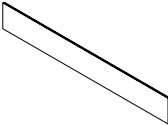
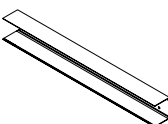
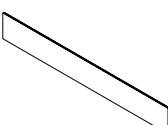
AL  
EV1-Deco  
anod  
(114)

Satin  
stainl  
steel  
(700)

Art. No.	Description	€/Piece	€/Piece
<b>Sets</b>			
	<b>03.772 VISUR set</b> consisting of RTS 85, top and bottom pivot	669,00	
	<b>03.773 VISUR set</b> consisting of top and bottom pivot, (without RTS 85)	402,00	
<b>Single components</b>			
	<b>03.775 VISUR transom tube profile</b> for single leaf doors (max. 1100 mm door panel width), in fixed length (please indicate clear width in mm)	112,00	
	<b>03.776 VISUR transom tube profile</b> for double leaf doors (max. 2 x 1100 mm door panel width), in fixed length (please indicate clear width in mm)	203,00	
	<b>03.777 VISUR transom tube cover profile</b> for single leaf doors (max. 1100 mm door panel width), in fixed length (please indicate clear width in mm)	34,00	
	<b>03.778 VISUR transom tube cover profile</b> for double leaf doors (max. 2 x 1100 mm door panel width), in fixed length (please indicate clear width in mm)	53,00	
	<b>03.789 VISUR transom tube profile</b> in stock length 6000 mm	515,00	
	<b>03.780 VISUR transom tube cover profile</b> in stock length 6000 mm	140,00	
	<b>29.950 Floor doorstop</b>	32,50	
	<b>29.951 Wall doorstop, short</b>	31,00	
	<b>29.952 Wall doorstop, long</b>	35,50	

# RP



Double action

Technical data	
Glass	TSG
Glass thickness	8, 10, 12 mm
Max. door weight	110 kg
Applications	1-/2 panels, sidelight, glass assembly
Material	Aluminium
Finishes	Anodised- and RAL-Colors (coated)
Specials	Alternative for floor spring Integrated transom closer



## Manual double action door systems

272 TENSOR

276 VISUR

280 RP - Frame profile with transom door closer

General accessories for double action doors

376 Centre and corner locks, strike boxes

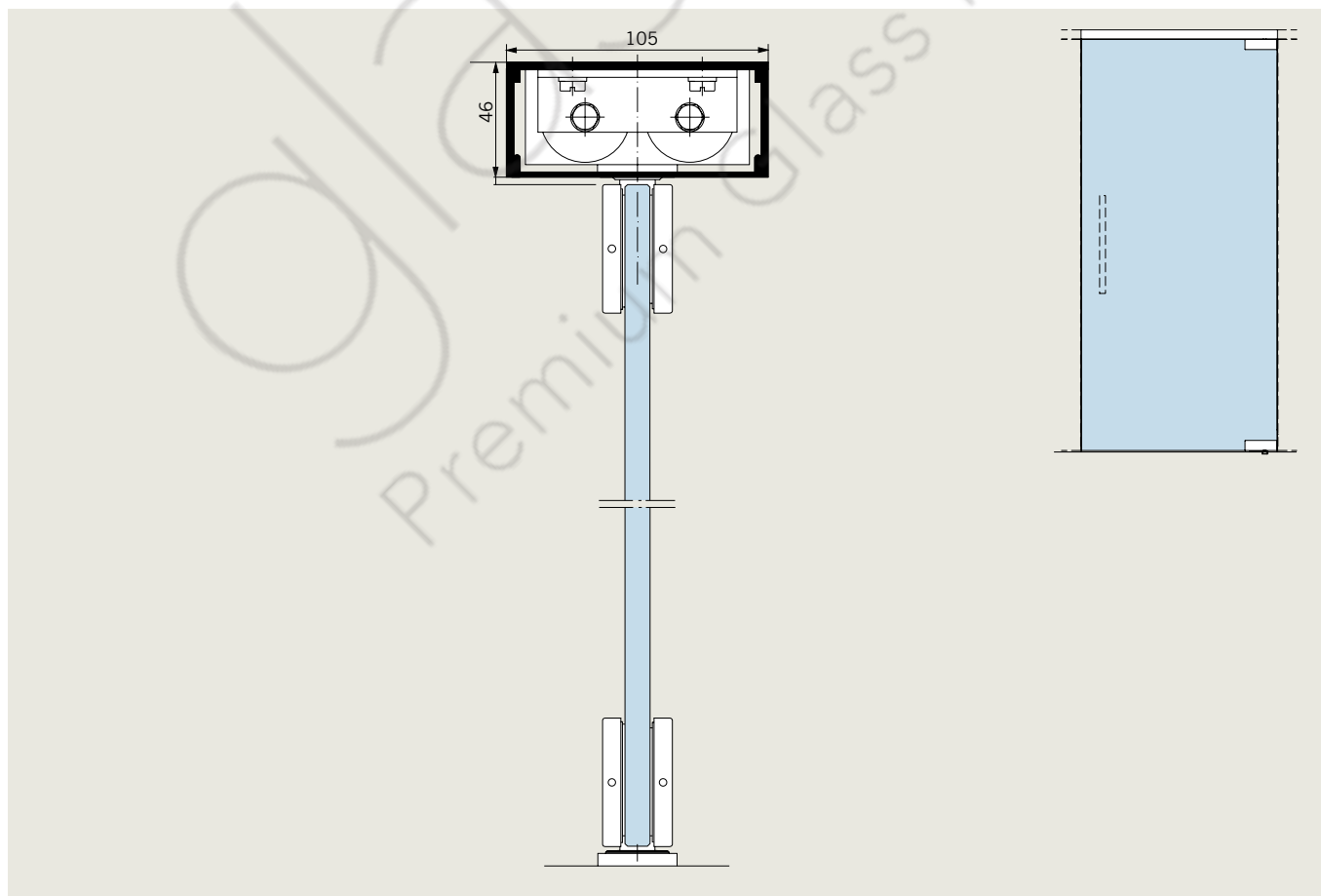

Example view for RP-Frame profile with transom door closer



Double action





Complete sets and single components

AL silver EV1 anod (101)	AL sim satin stainl steel anod C31 (113)	AL special color anod (199)	AL special color p-coat (399)
--------------------------	--	-----------------------------	-------------------------------

Art. No.	Description	€/m	€/m	€/m	€/m
<b>Complete set</b>					
	<b>01.300 Set RTS-System</b> consisting of:  1 m transom tube 01.301 1 m cover profile 01.302 1 RTS 85 EN3 (= size 2) with 90° hold open, completely installed in frame 1 fixing bracket 01.306, for wall fixing, installed 1 bottom patch fitting PT 10 1 top patch fitting PT 22 1 floor pivot bearing 01.106	€/Piece <b>567,00</b>	€/Piece <b>716,00</b>	€/Piece <b>743,00</b>	€/Piece <b>743,00</b>
Other assemblies, e.g. with side light or in other lengths: on request.					
<b>Single components</b>					
	<b>01.311</b> Transom tube 105/46 for RTS, fixed length	<b>48,00</b>	<b>68,00</b>	<b>76,50</b>	<b>76,50</b>
	<b>01.301</b> Transom tube 105/46 for RTS 6000 mm stock length	<b>38,50</b>	<b>53,50</b>	<b>61,50</b>	<b>61,50</b>
	<b>01.305</b> Cover profile for 01.301/311 fixed length	<b>21,50</b>	<b>39,00</b>	<b>42,50</b>	<b>42,50</b>
	<b>01.302</b> Cover profile for 01.301/311 6000 mm stock length  <b>max. 1100 mm with patch fitting</b> <b>max. 1250 mm with door rail</b>	<b>17,00</b>	<b>31,00</b>	<b>34,50</b>	<b>34,50</b>

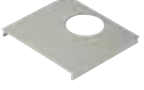
Double action

Single components

		Base parts (000)	AL silver EV1 anod (101)	AL sim satin stainl steel anod C31 (113)	AL special color anod (199)	AL special color p-coat (399)
Art. No.	Description	€/m	€/m	€/m	€/m	€/m
	<b>01.303</b> Cover plate of 01.302		€/Piece <b>19,00</b>	€/Piece <b>27,50</b>	€/Piece <b>31,00</b>	€/Piece <b>31,00</b>
	<b>01.314</b> Cover profile with glass groove to clip on art.no. 01.301/311, to hold fixed sidelights incl. contact and glass wedge profile for 8, 10 and 12 mm glass thickness, fixed length		<b>33,50</b>	<b>50,00</b>	<b>53,00</b>	<b>53,00</b>
	<b>01.304</b> Cover profile with glass groove to clip on art.no. 01.301/311, to hold fixed sidelights incl. contact and glass wedge profile for 8, 10 and 12 mm glass thickness, 6000 mm stock length		<b>26,50</b>	<b>41,00</b>	<b>43,00</b>	<b>43,00</b>
	<b>01.306</b> Fixing bracket for wall	€/Piece <b>9,90</b>				
	<b>U-Profile 20 x 20 x 20 x 2 mm</b>					
	<b>07.092</b> Stock length 6000 mm	(100) <b>4,90</b>	(150) <b>7,10</b>	<b>12,00</b>	<b>12,50</b>	<b>12,50</b>
	<b>07.093</b> Fixed length	(100) <b>6,10</b>	(150) <b>8,50</b>	<b>14,50</b>	<b>15,00</b>	<b>15,00</b>
	<b>U-Profile 30 x 20 x 30 x 2 mm</b>					
	<b>07.097</b> Stock length 6000 mm	(150) <b>9,70</b>	<b>17,00</b>			
	<b>07.096</b> Fixed length	(150) <b>12,50</b>	<b>21,50</b>			

Double action

# MUNDUS Comfort



Technical data	
Glass	TSG
Glass thickness	8-12 mm (for door panels)
Max. door weight	150 kg
Lock application	Euro profile cylinder, KABA
Applications	single/double leaf, sidelights, overpanels, glass assembly
Material	Aluminium, stainless steel
Finishes	Satin & polished stainless steel, anodised colors, powder coated
Specials	Multi dimensional adjustability For infinitely variable glass thicknesses (8 - 12 mm for door panels) Longevity: 500.000 cycles

## Fittings for toughened glass assemblies

- 284** MUNDUS Comfort
- 294** MUNDUS Premium
- 304** UNIVERSAL
- 316** UNIVERSAL Arcos
- 322** UNIVERSAL light
- 326** BEYOND
- 330** EA-Patch fittings for single action doors
- 338** Door rails
- 354** MANET Compact/Concept, Single action doors
- 366** Wall connecting profiles
- 372** Frame systems MR 22 & MR 28
- 376** DORMA SG – Centre and corner locks, strike boxes

### General accessories for toughened glass assemblies

- 387** Clamping fitting, U-profile
- 388** Pivot bearing, floor bearing, strike plates, floor sockets, profile cylinders
- 391** Locking unit for toughened glass assemblies

### Example view for MUNDUS Comfort

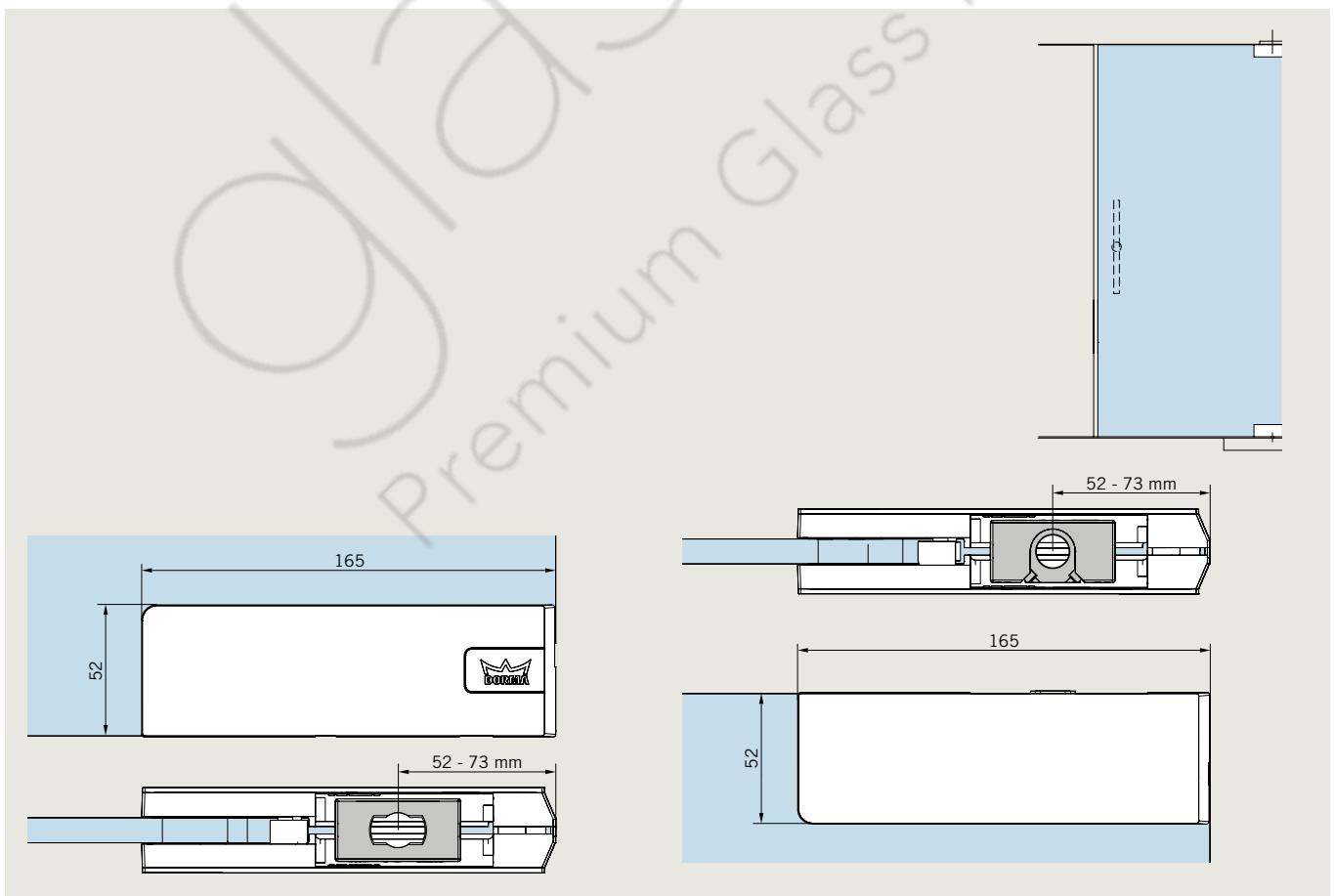

Patch fittings

AL silver anod (150)	AL white p-coat (350)	Satin stainl steel (750)	Polish stainl steel (751)
----------------------	-----------------------	--------------------------	---------------------------

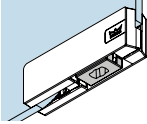
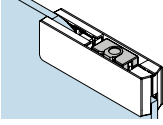
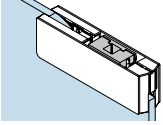
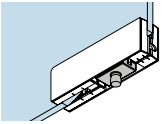
Art. No.	Description	€/Piece	€/Piece	€/Piece	€/Piece
<b>Single components</b>					
	<p><b>PT 10 Comfort bottom patch fitting</b> For glass weight up to 150 kg and use with toughened safety glass (TSG). With insert for flat-conical floor spring spindle or round pivot Ø 14 mm.</p>				
38.100	8-12 mm	76,50	76,50	76,50	76,50
	<p><b>PT 20 Comfort top patch fitting</b> For glass weight up to 150 kg and use with toughened safety glass (TSG). With plastic socket for pivot Ø 14 mm.</p>				
38.200	8-12 mm	76,50	76,50	76,50	76,50
	<p><b>PT 22 Comfort top patch fitting</b> For use with toughened safety glass (TSG). With insert for transom closer DORMA RTS.</p>				
38.220	8-12 mm	92,00	92,00	92,00	92,00
	<p><b>PT 30 Comfort overpanel patch fitting</b> For use with toughened safety glass (TSG). With pivot Ø 14 mm and M 8 tapped hole at side</p>				
38.300	8-12 mm	76,50	76,50	76,50	76,50

Patch fittings

AL silver anod (150)	AL white p-coat (350)	Satin stainl steel (750)	Polish stainl steel (751)
----------------------	-----------------------	--------------------------	---------------------------

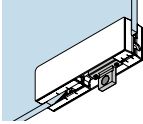
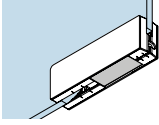
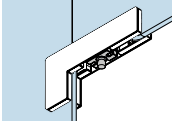
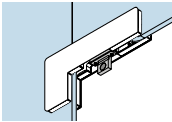
Art. No.	Description	€/Piece	€/Piece	€/Piece	€/Piece
<b>Single components</b>					
	<p><b>PT 30 Comfort overpanel patch fitting</b> For use with toughened safety glass (TSG ). With stop insert.</p>				
38.303	8-15 mm	76,50	76,50	76,50	76,50
	<p><b>PT 30 Comfort overpanel patch fitting</b> For use with toughened safety glass (TSG ). With blank insert.</p>				
38.306	8-15 mm	76,50	76,50	76,50	76,50
	<p><b>PT 40 Comfort patch for overpanel and sidelight</b> For use with toughened safety glass (TSG ). With pivot Ø 14 mm.</p>				
38.400	8-12 mm	106,00	106,00	106,00	106,00
	<p><b>PT 40 Comfort patch for overpanel and sidelight</b> For use with toughened safety glass (TSG ). With stop insert.</p>				
38.403	8-15 mm	106,00	106,00	106,00	106,00

Patch fittings

AL silver anod (150)	AL white p-coat (350)	Satin stainl steel (750)	Polish stainl steel (751)
-------------------------------	--------------------------------	-----------------------------------	------------------------------------

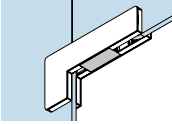
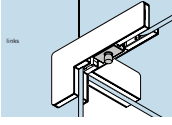
Art. No.	Description	€/Piece	€/Piece	€/Piece	€/Piece
<b>Single components</b>					
	<b>PT 40 Comfort patch for overpanel and sidelight</b> For use with toughened safety glass (TSG). With blank insert				
<b>38.406</b>	8-15 mm	106,00	106,00	106,00	106,00
	<b>PT 41 Comfort patch for overpanel and sidelight</b> For use with toughened safety glass (TSG). With pivot pin Ø 14 mm and fin fitting*.				
<b>With pivot</b>					
<b>38.410</b>	8-12 mm	left hand	229,00	229,00	229,00
<b>38.420</b>	8-12 mm	right hand	229,00	229,00	229,00
<b>With stop insert</b>					
<b>38.413</b>	8-15 mm	left hand	229,00	229,00	229,00
<b>38.423</b>	8-15 mm	right hand	229,00	229,00	229,00
<b>With blank insert</b>					
<b>38.416</b>	8-15 mm	left hand	229,00	229,00	229,00
<b>38.426</b>	8-15 mm	right hand	229,00	229,00	229,00

\*\* Left hand fin (illustration shows left hand) / right hand fin. Left or right hand are determined by view from outside..



Patch fittings

AL silver anod (150)	AL white p-coat (350)	Satin stainl steel (750)	Polish stainl steel (751)
----------------------	-----------------------	--------------------------	---------------------------

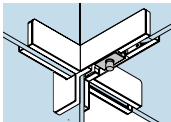
Art. No.	Description	€/Piece	€/Piece	€/Piece	€/Piece
<b>Single components</b>					
	<b>PT 41 Comfort patch for overpanel and sidelight</b> For use with toughened safety glass (TSG ). With pivot pin Ø 14 mm and fin fitting on both sides				
	<b>38.430 With pivot</b> 8-12 mm	367,00	367,00	367,00	367,00
	<b>38.433 With stop insert</b> 8-15 mm	367,00	367,00	367,00	367,00
	<b>38.436 With blank insert</b> 8-15 mm	367,00	367,00	367,00	367,00

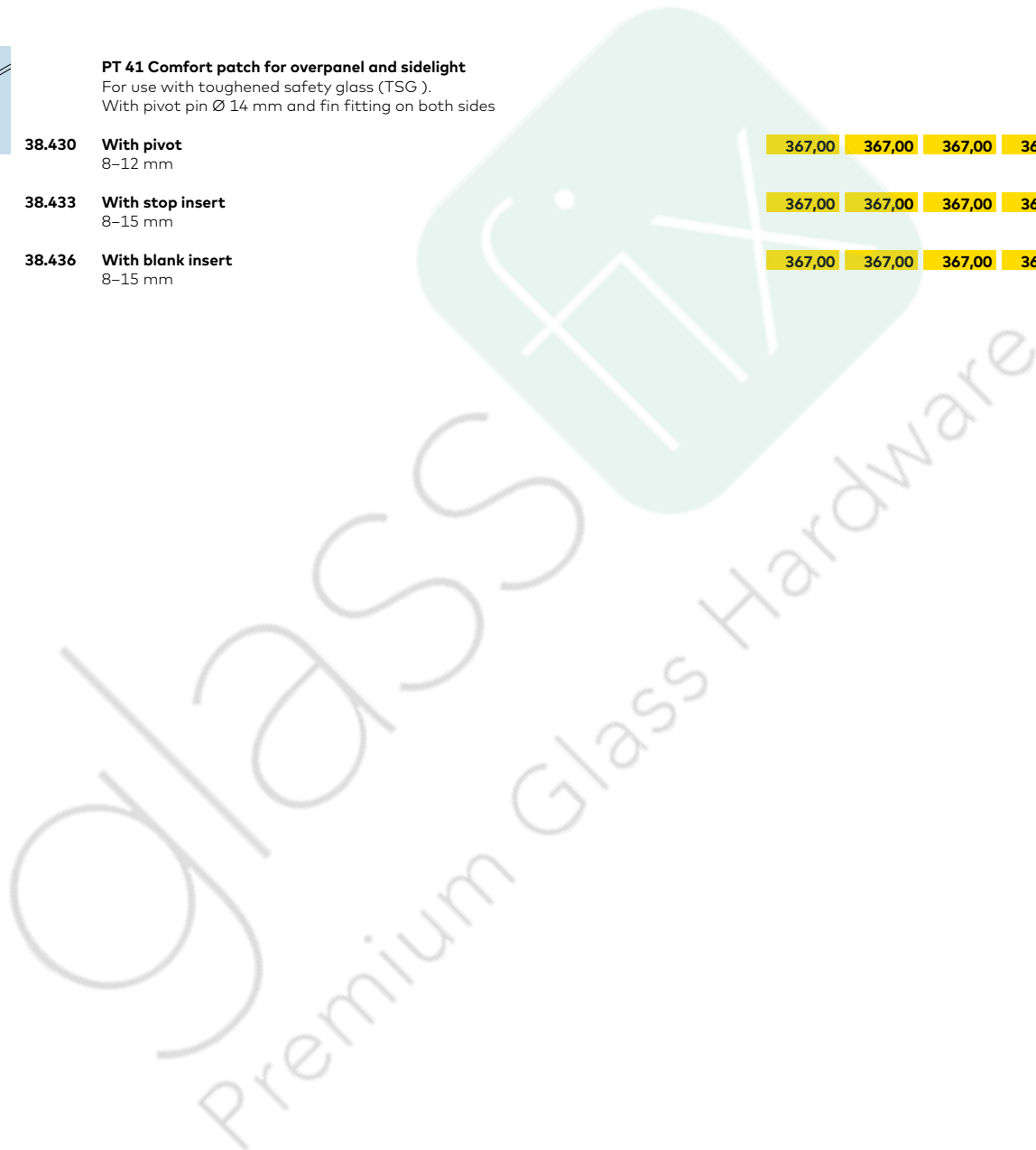

Connector patches

AL silver anod (150)	AL white p-coat (350)	Satin stainl steel (750)	Polish stainl steel (751)
-------------------------------	--------------------------------	-----------------------------------	------------------------------------

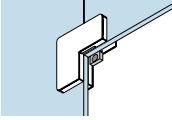
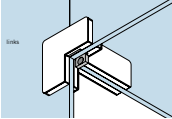
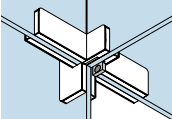
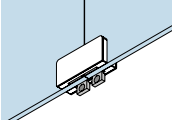
Art. No.	Description	€/Piece	€/Piece	€/Piece	€/Piece
<b>Single components</b>					
	<p><b>PT 60 Comfort connector</b> For use with toughened safety glass (TSG ). For double and single action doors. With 1 stop insert and 2 blank inserts.</p>				
<b>38.600</b>	8-15 mm	75,50	75,50	75,50	75,50
	<p><b>PT 61 Comfort connector</b> For use with toughened safety glass (TSG ). For double and single action doors. With 1 stop insert and 2 blank inserts. With fin fitting*</p>				
<b>38.610</b>	8-15 mm	left hand	184,00	184,00	184,00
<b>38.613</b>	8-15 mm	right hand	184,00	184,00	184,00
	<p><b>PT 61 Comfort connector</b> For use with toughened safety glass (TSG ). For double and single action doors. With 1 stop insert and 2 blank inserts. With fin fitting on both sides.</p>				
<b>38.616</b>	8-15 mm	298,00	298,00	298,00	298,00
	<p><b>PT 70 Comfort overpanel connector</b> For use with toughened safety glass (TSG ). With 2 stop inserts and 2 blank inserts.</p>				
<b>38.700</b>	8-15 mm	66,00	66,00	66,00	66,00

\*\* Left hand fin (illustration shows left hand) / right hand fin. Left or right hand are determined by view from outside..

**Locks and strike boxes**

AL silver anod (150)    AL white p-coat (350)    Satin stainl steel (750)    Polish stainl steel (751)

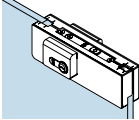
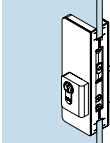
Art. No.	Description	€/Piece	€/Piece	€/Piece	€/Piece
<b>Single components</b>					
<b>US 10 Comfort corner lock</b> 8-19 mm glass thickness					
	<b>38.510</b> Euro profile cylinder, for use with toughened safety glass (TSG )	106,00	106,00	106,00	106,00
	<b>38.513</b> KABA, for use with toughened safety glass (TSG ).	106,00	106,00	106,00	106,00
<b>US 20 Comfort center lock</b> 8-19 mm glass thickness					
	<b>38.520</b> Euro profile cylinder, for use with toughened safety glass (TSG ).	106,00	106,00	106,00	106,00
	<b>38.523</b> KABA, for use with toughened safety glass (TSG ).	106,00	106,00	106,00	106,00

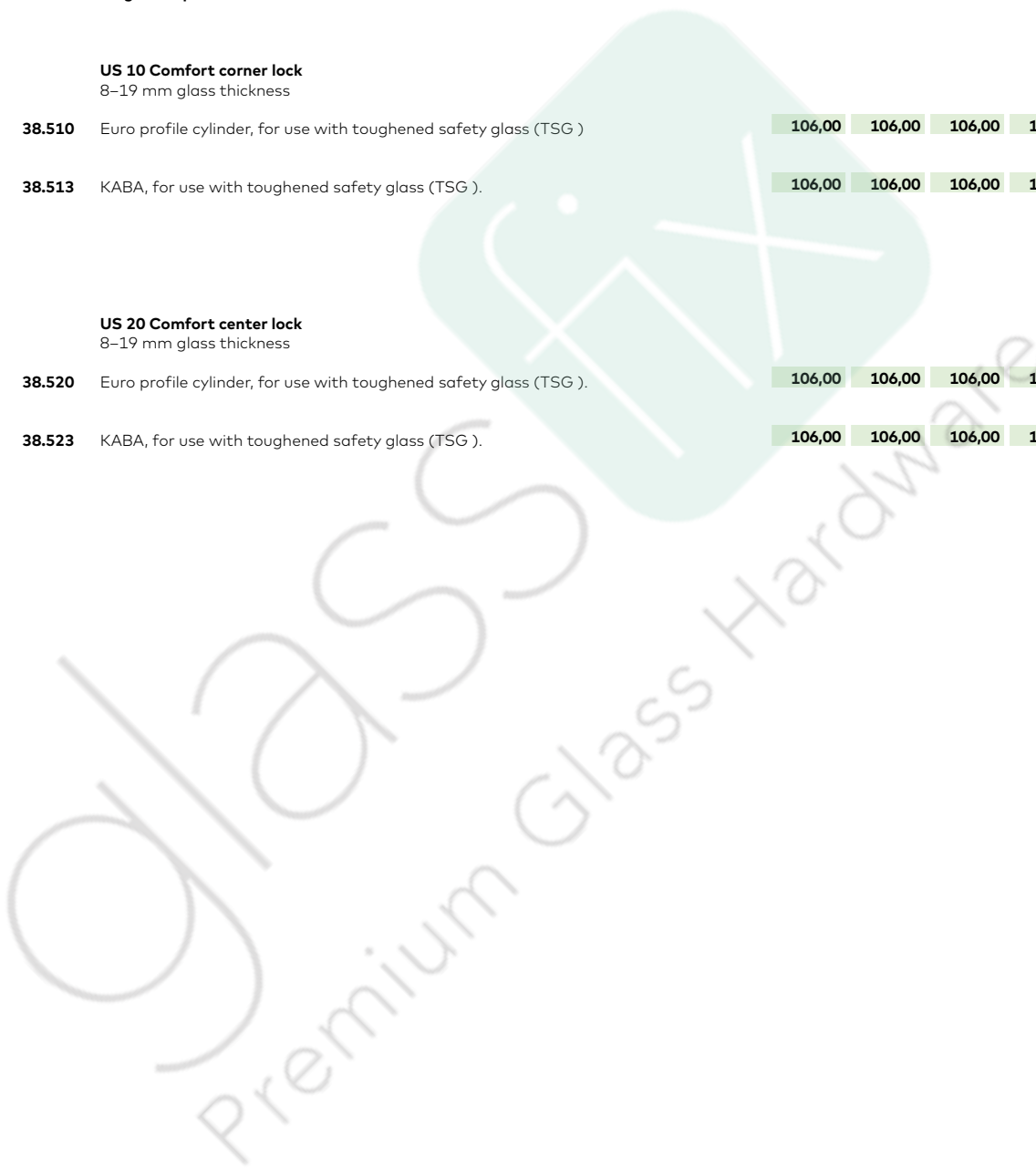

Glass assemblies

Locks and strike boxes

AL silver anod (150)	AL white p-coat (350)	Satin stainl steel (750)	Polish stainl steel (751)
-------------------------------	--------------------------------	-----------------------------------	------------------------------------

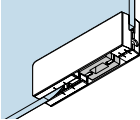
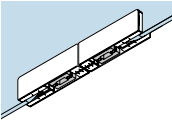
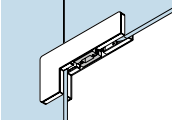
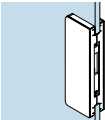



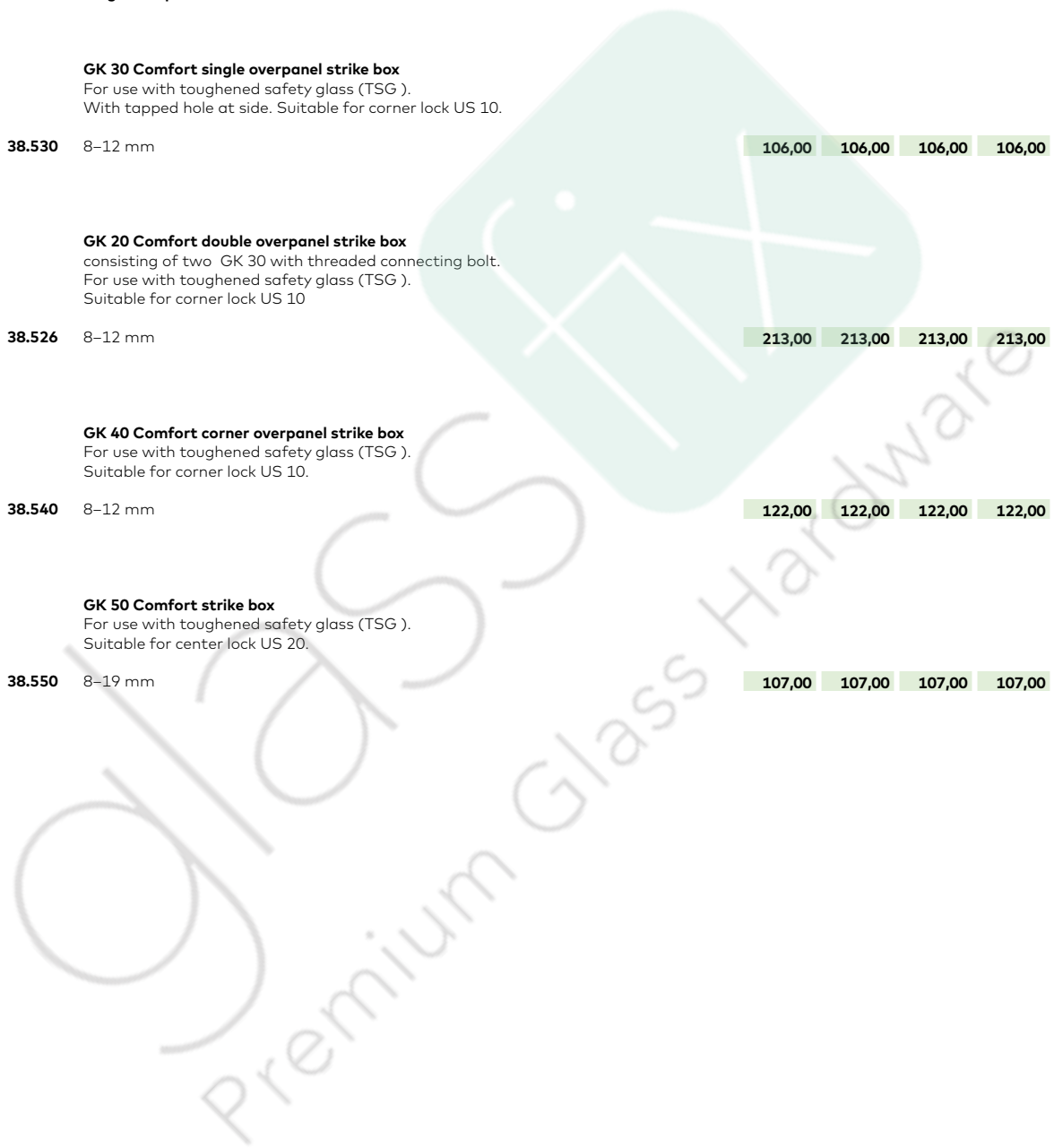



Art. No.	Description	€/Piece	€/Piece	€/Piece	€/Piece
<b>Single components</b>					
	<b>GK 30 Comfort single overpanel strike box</b> For use with toughened safety glass (TSG ). With tapped hole at side. Suitable for corner lock US 10.				
38.530	8-12 mm	106,00	106,00	106,00	106,00
	<b>GK 20 Comfort double overpanel strike box</b> consisting of two GK 30 with threaded connecting bolt. For use with toughened safety glass (TSG ). Suitable for corner lock US 10				
38.526	8-12 mm	213,00	213,00	213,00	213,00
	<b>GK 40 Comfort corner overpanel strike box</b> For use with toughened safety glass (TSG ). Suitable for corner lock US 10.				
38.540	8-12 mm	122,00	122,00	122,00	122,00
	<b>GK 50 Comfort strike box</b> For use with toughened safety glass (TSG ). Suitable for center lock US 20.				
38.550	8-19 mm	107,00	107,00	107,00	107,00

Glass assemblies



Accessories

Base parts (000)	AL silver anod (150)	AL white p-coat (350)	Satin stainl steel (750)	Polish stainl steel (751)
------------------	----------------------	-----------------------	--------------------------	---------------------------

Art. No.	Description	€/Piece	€/Piece	€/Piece	€/Piece	€/Piece
<b>Single components</b>						
	<b>38.210 MUNDUS PT 21</b> , top pivot with retractable bolt 14 mm Ø	39,00				
	<b>38.211 MUNDUS PT 21</b> , top pivot with retractable bolt 14 mm Ø and coverplate	42,50	42,50	42,50		
	<b>38.240 MUNDUS PT 24</b> , pivot 14 mm Ø, with fixing plate 6 mm, to let into the brickwork	16,00	16,00			
	<b>38.241 MUNDUS PT 24</b> , pivot 14 mm Ø, with fixing plate 3 mm, to screw onto the brickwork	16,00	16,00	16,00		
	<b>38.250 MUNDUS PT 25</b> pivot 14 mm Ø, with plug	5,80				
	<b>01.133 Wall anchor</b> , zinc plated for PT 30	7,10				
	<b>01.134 Threaded rod with wall plug</b> , for PT 30	7,10				
	<b>38.313 MUNDUS fixing plate for PT 30 / GK 30</b>			(st.st., white powder coated)	16,00	16,00

Glass assemblies

# MUNDUS Premium



Technical data	
Glass	TSG, LSG (2 x TSG)
Glass thickness	8 - 22 mm
Max. door weight	200 kg
Lock application	Euro profile cylinder, KABA
Applications	Single/double leaf, sidelights, overpanels, glass assembly
Material	Aluminium, Stainless steel, Glass (on request)
Finishes	Anodised colors, powder coated, wet coated, satin & polished stainless steel, Glass (on request)
Specials	Multi dimensional adjustability For infinitely variable glass thicknesses (8 - 22 mm) Longevity: 1.000.000 cycles

## Fittings for toughened glass assemblies

- 284** MUNDUS Comfort
- 294** MUNDUS Premium
- 304** UNIVERSAL
- 316** UNIVERSAL Arcos
- 322** UNIVERSAL light
- 326** BEYOND
- 330** EA-Patch fittings for single action doors
- 338** Door rails
- 354** MANET Compact/Concept, Single action doors
- 366** Wall connecting profiles
- 372** Frame systems MR 22 & MR 28
- 376** DORMA SG – Centre and corner locks, strike boxes

### General accessories for toughened glass assemblies

- 387** Clamping fitting, U-profile
- 388** Pivot bearing, floor bearing, strike plates, floor sockets, profile cylinders
- 391** Locking unit for toughened glass assemblies

### Example view for MUNDUS Premium

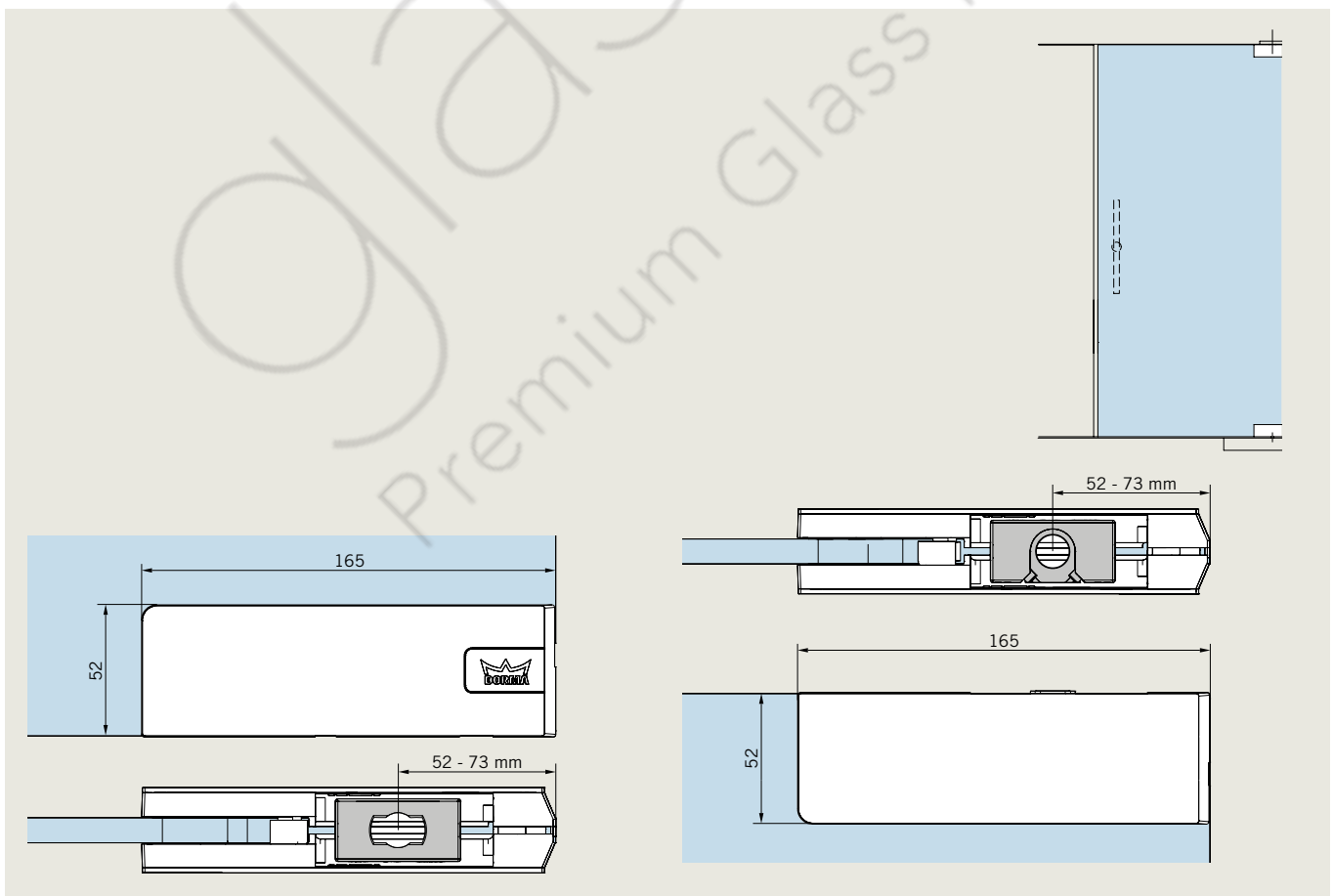

Patch fittings

AL silver anod (150)	AL white p-coat (350)	Satin stainl steel (750)	Polish stainl steel (751)	AL special color anod (199)	AL special color liquid coat (299)	AL special color p-coat (399)	Glass white (810)	Glass black (880)
----------------------	-----------------------	--------------------------	---------------------------	-----------------------------	------------------------------------	-------------------------------	-------------------	-------------------

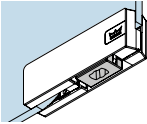
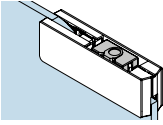
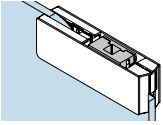
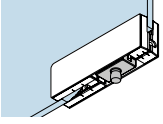
Art. No.	Description	€/Piece	€/Piece	€/Piece	€/Piece	€/Piece	€/Piece	€/Piece
<b>Single components</b>								
<b>PT 10 Premium bottom patch fitting</b>								
For glass weight up to 200 kg and use with toughened safety glass (TSG). Also prepared for use with laminated safety glass (LSG). With insert for flat-conical floor spring spindle or round pivot Ø 14 mm.								
	42.100 8-12 mm	102,00	102,00	102,00	102,00	112,00	112,00	158,00
	42.101 12-15 mm	119,00	119,00	119,00	119,00	130,00	130,00	172,00
	42.102 15-19 mm	141,00	141,00	141,00	141,00	155,00	155,00	196,00
	42.103 19-22 mm	164,00	164,00	164,00	164,00	181,00	181,00	205,00
<b>PT 20 Premium top patch fitting</b>								
For glass weight up to 200 kg and use with toughened safety glass (TSG). Also prepared for use with laminated safety glass (LSG). With plastic socket for pivot Ø 14 mm.								
	42.200 8-12 mm	102,00	102,00	102,00	102,00	112,00	112,00	158,00
	42.201 12-15 mm	119,00	119,00	119,00	119,00	130,00	130,00	172,00
	42.202 15-19 mm	141,00	141,00	141,00	141,00	155,00	155,00	196,00
	42.203 19-22 mm	164,00	164,00	164,00	164,00	181,00	181,00	205,00
<b>PT 22 Premium top patch fitting</b>								
For use with toughened safety glass (TSG). Also prepared for use with laminated safety glass (LSG). With insert for transom closer DORMA RTS.								
	42.220 8-12 mm	118,00	118,00	118,00	118,00	129,00	129,00	174,00
	42.221 12-15 mm	133,00	133,00	133,00	133,00	147,00	147,00	189,00
	42.222 15-19 mm	157,00	157,00	157,00	157,00	172,00	172,00	213,00
	42.223 19-22 mm	180,00	180,00	180,00	180,00	197,00	197,00	222,00
<b>PT 30 Premium overpanel patch fitting</b>								
For use with toughened safety glass (TSG). Also prepared for use with laminated safety glass (LSG). With pivot Ø 14 mm and M 8 tapped hole at side.								
	42.300 8-12 mm	102,00	102,00	102,00	102,00	112,00	112,00	158,00
	42.301 12-15 mm	119,00	119,00	119,00	119,00	130,00	130,00	172,00
	42.302 15-19 mm	141,00	141,00	141,00	141,00	155,00	155,00	196,00
	42.310 19-22 mm	164,00	164,00	164,00	164,00	181,00	181,00	205,00

Glass assemblies



Patch fittings

AL silver anod (150)	AL white p-coat (350)	Satin stainl steel (750)	Polish stainl steel (751)	AL special color anod (199)	AL special color liquid coat (299) AL special color p-coat (399)	Glass white (810) Glass black (880)
€/Piece	€/Piece	€/Piece	€/Piece	€/Piece	€/Piece	€/Piece

Art. No.	Description	€/Piece	€/Piece	€/Piece	€/Piece	€/Piece	€/Piece
----------	-------------	---------	---------	---------	---------	---------	---------

Single components

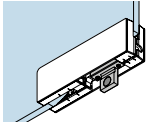

**PT 30 Premium overpanel patch fitting**

For use with toughened safety glass (TSG). Also prepared for use with laminated safety glass (LSG) With stop insert.

42.303	8-15 mm
42.305	15-19 mm
42.311	19-22 mm

102,00	102,00	102,00	102,00	112,00	112,00	158,00
141,00	141,00	141,00	141,00	155,00	155,00	196,00
164,00	164,00	164,00	164,00	181,00	181,00	205,00

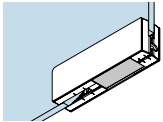

**PT 30 Premium overpanel patch fitting**

For use with toughened safety glass (TSG). Also prepared for use with laminated safety glass (LSG) With blank insert.

42.306	8-15 mm
42.308	15-19 mm
42.312	19-22 mm

102,00	102,00	102,00	102,00	112,00	112,00	158,00
141,00	141,00	141,00	141,00	155,00	155,00	196,00
164,00	164,00	164,00	164,00	181,00	181,00	205,00

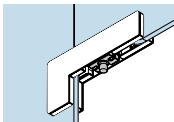

**PT 40 Premium patch for overpanel and sidelight**

For use with toughened safety glass (TSG). Also prepared for use with laminated safety glass (LSG) With pivot Ø 14 mm.

42.400	8-12 mm
42.401	12-15 mm
42.402	15-19 mm
42.470	19-22 mm

127,00	127,00	127,00	127,00	140,00	140,00	182,00
143,00	143,00	143,00	143,00	158,00	158,00	198,00
166,00	166,00	166,00	166,00	183,00	183,00	221,00
189,00	189,00	189,00	189,00	208,00	208,00	244,00

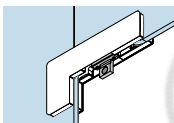

**PT 40 Premium patch for overpanel and sidelight**

For use with toughened safety glass (TSG). Also prepared for use with laminated safety glass (LSG) With stop insert.

42.403	8-15 mm
42.405	15-19 mm
42.471	19-22 mm

127,00	127,00	127,00	127,00	140,00	140,00	182,00
166,00	166,00	166,00	166,00	183,00	183,00	221,00
189,00	189,00	189,00	189,00	208,00	208,00	244,00



Glass assemblies

Patch fittings

Art. No.	Description	AL silver anod (150)	AL white p-coat (350)	Satin stainl steel (750)	Polish stainl steel (751)	AL special color anod (199)	AL special color liquid coat (299) AL special color p-coat (399)	Glass white (810) Glass black (880)
----------	-------------	----------------------	-----------------------	--------------------------	---------------------------	-----------------------------	---	--

Art. No.	Description	€ / Piece	€ / Piece	€ / Piece	€ / Piece	€ / Piece	€ / Piece	€ / Piece
<b>Single components</b>								
<b>PT 40 Premium patch for overpanel and sidelight</b>								
For use with toughened safety glass (TSG). Also prepared for use with laminated safety glass (LSG). With blank insert.								
	<b>42.406</b>	8-15 mm	127,00	127,00	127,00	127,00	140,00	140,00
	<b>42.408</b>	15-19 mm	166,00	166,00	166,00	166,00	183,00	183,00
	<b>42.409</b>	19-22 mm	189,00	189,00	189,00	189,00	208,00	208,00
								182,00
								221,00
								244,00
<b>PT 41 Premium patch for overpanel and sidelight</b>								
For use with toughened safety glass (TSG). Also prepared for use with laminated safety glass (LSG). With pivot pin Ø 14 mm and fin fitting*.								
<b>With pivot</b>								
	<b>42.410</b>	8-12 mm left hand	218,00	218,00	218,00	218,00	239,00	239,00
	<b>42.420</b>	8-12 mm right hand	218,00	218,00	218,00	218,00	239,00	239,00
	<b>42.411</b>	12-15 mm left hand	234,00	234,00	234,00	234,00	257,00	257,00
	<b>42.421</b>	12-15 mm right hand	234,00	234,00	234,00	234,00	257,00	257,00
	<b>42.412</b>	15-19 mm left hand	257,00	257,00	257,00	257,00	283,00	283,00
	<b>42.422</b>	15-19 mm right hand	257,00	257,00	257,00	257,00	283,00	283,00
	<b>42.472</b>	19-22 mm left hand	280,00	280,00	280,00	280,00	308,00	308,00
	<b>42.474</b>	19-22 mm right hand	280,00	280,00	280,00	280,00	308,00	308,00
<b>With stop insert</b>								
	<b>42.413</b>	8-15 mm left hand	218,00	218,00	218,00	218,00	239,00	239,00
	<b>42.423</b>	8-15 mm right hand	218,00	218,00	218,00	218,00	239,00	239,00
	<b>42.415</b>	15-19 mm left hand	257,00	257,00	257,00	257,00	283,00	283,00
	<b>42.425</b>	15-19 mm right hand	257,00	257,00	257,00	257,00	283,00	283,00
	<b>42.473</b>	19-22 mm left hand	280,00	280,00	280,00	280,00	308,00	308,00
	<b>42.475</b>	19-22 mm right hand	280,00	280,00	280,00	280,00	308,00	308,00
<b>With blank insert</b>								
	<b>42.416</b>	8-15 mm left hand	218,00	218,00	218,00	218,00	239,00	239,00
	<b>42.426</b>	8-15 mm right hand	218,00	218,00	218,00	218,00	239,00	239,00
	<b>42.418</b>	15-19 mm left hand	257,00	257,00	257,00	257,00	283,00	283,00
	<b>42.428</b>	15-19 mm right hand	257,00	257,00	257,00	257,00	283,00	283,00
	<b>42.419</b>	19-22 mm left hand	280,00	280,00	280,00	280,00	308,00	308,00
	<b>42.429</b>	19-22 mm right hand	280,00	280,00	280,00	280,00	308,00	308,00

\* Left hand fin (illustration shows left hand) / right hand fin. Left or right hand are determined by view from outside.

Patch fittings

AL silver anod (150)	AL white p-coat (350)	Satin stainl steel (750)	Polish stainl steel (751)	AL special color anod (199)	AL special color liquid coat (299) AL special color p-coat (399)	Glass white (810) Glass black (880)
€/Piece	€/Piece	€/Piece	€/Piece	€/Piece	€/Piece	€/Piece

Art. No.	Description	€/Piece	€/Piece	€/Piece	€/Piece	€/Piece	€/Piece
----------	-------------	---------	---------	---------	---------	---------	---------

Single components

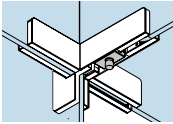

**PT 41 Premium patch for overpanel and sidelight**

For use with toughened safety glass (TSG).  
Also prepared for use with laminated safety glass (LSG).  
With pivot pin 14 mm Ø and fin fitting on both sides.

- With pivot**
- 42.430 8-12 mm
  - 42.431 12-15 mm
  - 42.432 15-19 mm
  - 42.476 19-22 mm

367,00	367,00	367,00	367,00	404,00	404,00
383,00	383,00	383,00	383,00	406,00	406,00
406,00	406,00	406,00	406,00	447,00	447,00
429,00	429,00	429,00	429,00	472,00	472,00

- With stop insert**
- 42.433 8-15 mm
  - 42.435 15-19 mm
  - 42.477 19-22 mm

367,00	367,00	367,00	367,00	404,00	404,00
406,00	406,00	406,00	406,00	447,00	447,00
429,00	429,00	429,00	429,00	472,00	472,00

- With blank insert**
- 42.436 8-15 mm
  - 42.438 15-19 mm
  - 42.439 19-22 mm

367,00	367,00	367,00	367,00	404,00	404,00
406,00	406,00	406,00	406,00	447,00	447,00
429,00	429,00	429,00	429,00	472,00	472,00



Connector patches

AL silver anod (150)	AL white p-coat (350)	Satin stainl steel (750)	Polish stainl steel (751)	AL special color anod (199)	AL special color liquid coat (299)	AL special color p-coat (399)	Glass white (810)	Glass black (880)
----------------------	-----------------------	--------------------------	---------------------------	-----------------------------	------------------------------------	-------------------------------	-------------------	-------------------

Art. No.	Description	€/Piece	€/Piece	€/Piece	€/Piece	€/Piece	€/Piece	€/Piece
<b>Single components</b>								
<b>PT 60 Premium connector</b>								
For use with toughened safety glass (TSG). Also prepared for use with laminated safety glass (LSG). For double and single action doors. with 1 stop insert and 2 blank inserts.								
	42.600 8-15 mm	87,00	87,00	87,00	87,00	96,00	96,00	141,00
	42.602 15-19 mm	126,00	126,00	126,00	126,00	138,00	138,00	181,00
	42.603 19-22 mm	149,00	149,00	149,00	149,00	164,00	164,00	203,00
<b>PT 61 Premium connector</b>								
For use with toughened safety glass (TSG). Also prepared for use with laminated safety glass (LSG). For double and single action doors. With 1 stop insert and 2 blank inserts. With fin fitting*								
	42.610 8-15 mm left hand	182,00	182,00	182,00	182,00	199,00	199,00	
	42.613 8-15 mm right hand	182,00	182,00	182,00	182,00	199,00	199,00	
	42.612 15-19 mm left hand	220,00	220,00	220,00	220,00	243,00	243,00	
	42.615 15-19 mm right hand	220,00	220,00	220,00	220,00	243,00	243,00	
	42.604 19-22 mm left hand	244,00	244,00	244,00	244,00	267,00	267,00	
	42.605 19-22 mm right hand	244,00	244,00	244,00	244,00	267,00	267,00	
<b>PT 61 Premium connector</b>								
For use with toughened safety glass (TSG). Also prepared for use with laminated safety glass (LSG). For double and single action doors. With 1 stop insert and 2 blank inserts. With fin fitting on both sides.								
	42.616 8-15 mm	321,00	321,00	321,00	321,00	353,00	353,00	
	42.618 15-19 mm	360,00	360,00	360,00	360,00	396,00	396,00	
	42.619 19-22 mm	383,00	383,00	383,00	383,00	421,00	421,00	
<b>PT 70 Premium overpanel connector</b>								
For use with toughened safety glass (TSG). Also prepared for use with laminated safety glass (LSG). With 2 stop inserts and 2 blank inserts.								
	42.700 8-15 mm	80,50	80,50	80,50	80,50	88,00	88,00	135,00
	42.702 15-19 mm	120,00	120,00	120,00	120,00	131,00	131,00	173,00
	42.703 19-22 mm	142,00	142,00	142,00	142,00	157,00	157,00	197,00

\* Left hand fin (illustration shows left hand) / right hand fin. Left or right hand are determined by view from outside.

Locks and strike boxes

AL silver anod (150)	AL white p-coat (350)	Satin stainl steel (750)	Polish stainl steel (751)	AL special color anod (199)	AL special color liquid coat (299) AL special color p-coat (399)	Glass white (810) Glass black (880)
€/Piece	€/Piece	€/Piece	€/Piece	€/Piece	€/Piece	€/Piece

Art. No.	Description	€/Piece	€/Piece	€/Piece	€/Piece	€/Piece	€/Piece
----------	-------------	---------	---------	---------	---------	---------	---------

Single components

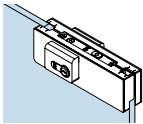

US 10 Premium corner lock

Prepared for Euro profile cylinder, single throw, bolt projection 20 mm, with security roses on both sides 14 mm thick, for use with toughened safety glass (TSG ). Also prepared for use with laminated safety glass (LSG).

Lock insert:

- maximum corrosion resistance according to EN 1670, class 4
- maximum corrosion resistance according to DIN 18251 / (EN 12209) class 3\*\*

42.510	8-19 mm	132,00	132,00	132,00	146,00	146,00	146,00	187,00
42.517	19-22 mm	148,00	148,00	148,00	171,00	171,00	171,00	202,00

Prepared for KABA (Swiss profile round cylinder 22 mm) for use with toughened safety glass (TSG ). Also prepared for use with laminated safety glass (LSG).

42.513	8-19 mm	171,00	171,00	171,00	188,00	188,00	188,00	226,00
42.516	19-22 mm	194,00	194,00	194,00	214,00	214,00	214,00	249,00

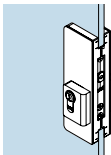

US 20 Premium center lock

Prepared for Euro profile cylinder, single throw, bolt projection 20 mm, with security roses 14 mm thick, for use with toughened safety glass (TSG ).

Also prepared for use with laminated safety glass (LSG ).

Lock insert:

- maximum corrosion resistance according to EN 1670, class 4
- maximum corrosion resistance according to DIN 18251 / (EN 12209) class 3\*

42.520	8-19 mm	132,00	132,00	132,00	146,00	146,00	146,00	187,00
42.518	19-22 mm	148,00	148,00	148,00	171,00	171,00	171,00	202,00

Prepared for KABA (Swiss profile round cylinder 22 mm) for use with toughened safety glass (TSG ). Also prepared for use with laminated safety glass (LSG).

42.523	8-19 mm	171,00	171,00	171,00	188,00	188,00	188,00	226,00
42.519	19-22 mm	194,00	194,00	194,00	214,00	214,00	214,00	249,00

\* Extract from DIN 18251, class 3: Type-test with 50,000 locking bolt operating cycles. Furthermore the lock was tested successfully by a neutral testing institute with 100,000 locking bolt operating cycles.

Locks and strike boxes

AL silver anod (150)	AL white p-coat (350)	Satin stainl steel (750)	Polish stainl steel (751)	AL special color anod (199)	AL special color liquid coat (299) AL special color p-coat (399)	Glass white (810) Glass black (880)
----------------------	-----------------------	--------------------------	---------------------------	-----------------------------	---	--

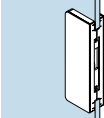
Art. No.	Description	€/Piece	€/Piece	€/Piece	€/Piece	€/Piece	€/Piece
<b>Single components</b>							
<b>GK 30 Premium single overpanel strike box</b>							
For use with toughened safety glass (TSG). Also prepared for use with laminated safety glass (LSG). With tapped hole at side. Suitable for corner lock US 10.							
	42.530 8-15 mm	132,00	132,00	132,00	132,00	146,00	146,00
	42.532 15-19 mm	171,00	171,00	171,00	171,00	188,00	188,00
	42.548 19-22 mm	194,00	194,00	194,00	194,00	214,00	214,00
<b>GK 20 Premium double overpanel strike box</b>							
Consisting of two GK 30 with threaded connecting bolt. For use with toughened safety glass (TSG). Also prepared for use with laminated safety glass (LSG). Suitable for corner lock US 10.							
	42.526 8-15 mm	264,00	264,00	264,00	264,00	290,00	290,00
	42.528 15-19 mm	303,00	303,00	303,00	303,00	333,00	333,00
	42.529 19-22 mm	326,00	326,00	326,00	326,00	358,00	358,00
<b>GK 40 Premium corner overpanel strike box</b>							
For use with toughened safety glass (TSG). Also prepared for use with laminated safety glass (LSG). Suitable for corner lock US 10.							
	42.540 8-15 mm	148,00	148,00	148,00	148,00	162,00	162,00
	42.542 15-19 mm	187,00	187,00	187,00	187,00	205,00	205,00
	42.547 19-22 mm	209,00	209,00	209,00	209,00	230,00	230,00
<b>GK 40 Premium corner overpanel strike box</b>							
For use with toughened safety glass (TSG). Suitable for corner lock US 10.							
	38.540 8-12 mm	122,00	122,00	122,00	122,00		
<b>GK 50 Premium strike box</b>							
For use with toughened safety glass (TSG). Also prepared for use with laminated safety glass (LSG). Suitable for center lock US 20.							
	42.550 8-19 mm	148,00	148,00	148,00	148,00	162,00	162,00
	42.553 19-22 mm	170,00	170,00	170,00	170,00	188,00	188,00

Accessories

Base parts (000)	AL silver anod (150)	AL white p-coat (350)	Satin stainl steel (750)	Polish stainl steel (751)
------------------	----------------------	-----------------------	--------------------------	---------------------------

Art. No.	Description	€/Piece	€/Piece	€/Piece	€/Piece	€/Piece
<b>Single components</b>						
	<b>38.210 MUNDUS PT 21</b> , top pivot with retractable bolt 14 mm Ø	39,00				
	<b>38.211 MUNDUS PT 21</b> , top pivot with retractable bolt 14 mm Ø and coverplate	42,50	42,50	42,50		
	<b>38.240 MUNDUS PT 24</b> , pivot 14 mm Ø, with fixing plate 6 mm, to let into the brickwork	16,00	16,00			
	<b>38.241 MUNDUS PT 24</b> , pivot 14 mm Ø, with fixing plate 3 mm, to screw onto the brickwork	16,00	16,00	16,00		
	<b>38.250 MUNDUS PT 25</b> pivot 14 mm Ø, with plug	5,80				
	<b>01.133 Wall anchor</b> , zinc plated for PT 30	7,10				
	<b>01.134 Threaded rod with wall plug</b> , for PT 30	7,10				
	<b>38.313 MUNDUS fixing plate for PT 30 / GK 30</b>				(stainl steel white p-coat) 16,00	16,00 16,00
	<b>07.631 Special adhesive and mixing jet for use with LSG</b> (sufficient for ca. 12 patch fittings) For more LSG components, see page 115	82,00				
	<b>42.951 MUNDUS Premium LSG gaskets</b> , PT 10/20/30	7,10				
	<b>42.952 MUNDUS Premium LSG gaskets</b> , PT 40	8,20				
	<b>42.953 MUNDUS Premium LSG gaskets</b> , PT 60	7,10				
	<b>42.954 MUNDUS Premium LSG gaskets</b> , PT 70	7,10				
	<b>42.955 MUNDUS Premium LSG gaskets</b> , US 10/20	7,10				

# UNIVERSAL



Technical data	
Glass	TSG
Glass thickness	8, 10, 12, 13 - 19 mm
Max. door weight	110 kg
Lock application	DORMA SG locks (non-lockable, profile cylinder, KABA cylinder), Patch locks
Applications	24 Standard types for toughened glass assemblies
Material	Aluminium, brass, stainless steel
Finishes	Anodised and RAL colors, brass, stainless steel
Specials	Suitable for outdoor assemblies



24 Standard types for toughened glass assemblies

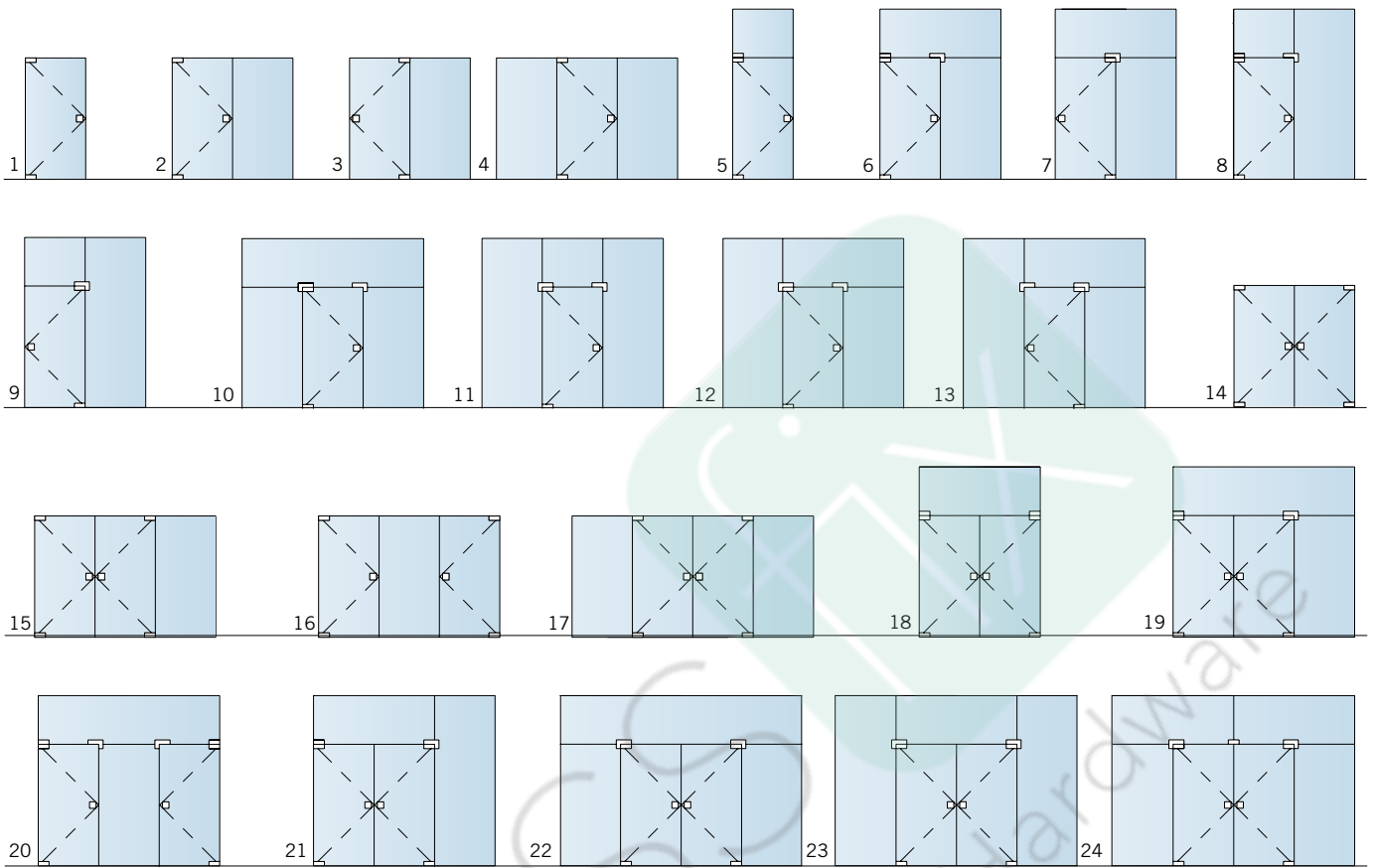



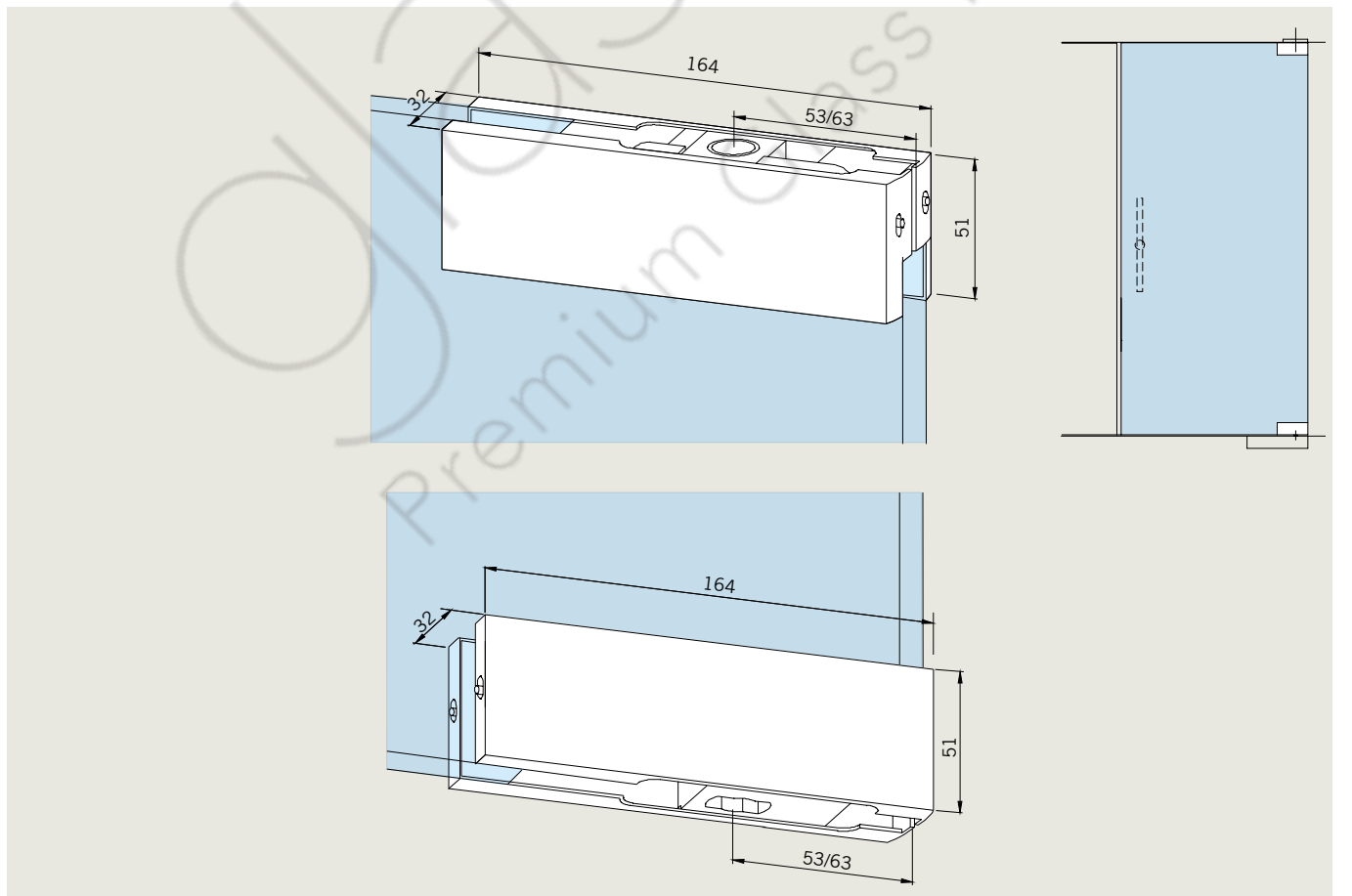









Example view for UNIVERSAL

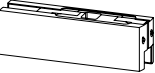

Glass assemblies

For 10 mm glass thickness









Base parts (000)	AL silver EV1 anod (101)	AL traffic white p-coat (300)	Brass polish (503)	Brass polish chromed (501)	Satin stainl steel (700)	Polish stainl steel (701)	AL special color anod (199)	AL special color p-coat (399)
------------------	--------------------------	-------------------------------	--------------------	----------------------------	--------------------------	---------------------------	-----------------------------	-------------------------------

Art. No.	Description	€/Piece	€/Piece	€/Piece	€/Piece	€/Piece	€/Piece	€/Piece	€/Piece	€/Piece
<b>Patch / connecting fittings, locks, and strike-boxes for double action doors</b>										
	<b>03.100 PT 10 UNIVERSAL bottom patch fitting</b>	57,00	57,00	80,00	100,00	78,50	87,00	79,00	79,00	
	<b>01.137 Floor pivot bearing for damp environments, with insert for UNIVERSAL for mounting onto floor surface, max. door weight 80 kg</b>	51,00								
	<b>03.206 US 10 UNIVERSAL corner lock</b>	89,50	89,50	127,00	150,00	127,00	142,00	125,00	125,00	
	<b>03.110 PT 20 UNIVERSAL top patch fitting</b>	55,50	55,50	79,50	99,00	78,00	85,50	77,50	77,50	
	<b>03.112 PT 22 UNIVERSAL top patch fitting for RTS transom closer</b>	87,00				109,00	119,00	121,00	121,00	
	<b>03.114 PT 29 UNIVERSAL top patch fitting with fixing angle</b>	106,00	106,00	149,00	158,00			149,00	149,00	
	<b>03.215 US 20 UNIVERSAL centre lock</b>	93,50	93,50	135,00	157,00	135,00	149,00	133,00	133,00	
	<b>03.224 GK 50 UNIVERSAL strike-box</b>	93,00	93,00	134,00	156,00	134,00	148,00	131,00	131,00	
	<b>03.120 PT 30 UNIVERSAL overpanel patch fitting with pivot Ø 15 mm</b>	58,00	58,00	79,50	102,00	79,50	88,00	81,00	81,00	
	<b>03.420 PT 30 UNIVERSAL overpanel patch fitting with stop insert</b>	57,50	57,50	79,50	102,00	79,50	88,00	81,00	81,00	
	<b>03.421 PT 30 UNIVERSAL overpanel patch fitting with blank insert</b>	56,00		78,50	100,00	78,50	86,00	79,50	79,50	
	<b>03.128 Fixing plate for PT 30</b>	9,30	9,30	29,00	35,00			13,00	13,00	
	<b>01.133 Wall anchor, zinc plated for PT 30</b>	7,10								
	<b>01.134 Threaded rod with wall plug, for PT 30</b>	6,90								

Glass assemblies

For 10 mm glass thickness



AL silver EV1 anod (101)    AL traffic white p-coat (300)    Brass polish (503)    Brass polish chromed (501)    Satin stainl steel (700)    Polish stainl steel (701)    AL special color anod (199)    AL special color p-coat (399)

Art. No.	Description	AL silver EV1 anod (101)	AL traffic white p-coat (300)	Brass polish (503)	Brass polish chromed (501)	Satin stainl steel (700)	Polish stainl steel (701)	AL special color anod (199)	AL special color p-coat (399)
	<b>03.230 GK 30 UNIVERSAL overpanel strike-box</b>	93,00	93,00		156,00	134,00	148,00	131,00	131,00
	<b>03.245 GK 20 UNIVERSAL double overpanel strike-box, consisting of 2 x GK 30 with threaded rod</b>	149,00	149,00			227,00	252,00	211,00	211,00
	<b>03.140 PT 40 UNIVERSAL patch fitting for overpanel and sidelight, with pivot insert Ø 15 mm</b>	76,00	76,00	110,00	135,00	110,00	121,00	106,00	106,00
	<b>03.440 PT 40 UNIVERSAL patch fitting for overpanel and sidelight, with stop insert</b>	76,00	76,00	110,00	135,00	110,00	121,00	106,00	106,00
	<b>03.441 PT 40 UNIVERSAL patch fitting for overpanel and sidelight, with blank insert</b>	74,50	74,50	109,00	133,00	109,00	119,00	105,00	105,00
	<b>03.250 GK 40 UNIVERSAL corner overpanel strike-box</b>	111,00	111,00		188,00	159,00	178,00	159,00	159,00
	<b>03.162 PT 41 UNIVERSAL patch fitting for overpanel and sidelight with fin on one side</b>	- LH	199,00			253,00	279,00	280,00	280,00
	<b>03.163 do.</b>	- RH	199,00			253,00	279,00	280,00	280,00
	<b>03.262 do. with stop insert</b>	- LH	199,00			253,00	279,00	280,00	280,00
	<b>03.263 do.</b>	- RH	199,00			253,00	279,00	280,00	280,00
	<b>03.264 do. with blank insert</b>	- LH	199,00			253,00	279,00	280,00	280,00
	<b>03.265 do.</b>	- RH	199,00			253,00	279,00	280,00	280,00
	<b>03.150 PT 60/61 UNIVERSAL connector for overpanel and sidelight (also for 12 mm glass thickness) with inserts (1 x stop, 2 x blank)</b>	61,00	61,00	99,50	122,00	99,50	107,00	86,00	86,00
	<b>01.150 PT 70 UNIVERSAL overpanel connector (also for 12 mm glass thickness) with inserts (2 x stop, 2 x blank)</b>	56,00	58,00		103,00	77,00	84,50	83,50	83,50

Glass assemblies

For 10 mm glass thickness



AL silver EV1 anod (101)    AL traffic white p-coat (300)    Brass polish (503)    Brass polish chromed (501)    Satin stainl steel (700)    Polish stainl steel (701)    AL special color anod (199)    AL special color p-coat (399)

Art. No.	Description	€/Piece	€/Piece	€/Piece	€/Piece	€/Piece	€/Piece	€/Piece	€/Piece
	12.536 Overpanel-sidelight connector	(114) 36,50				(113) 43,50		47,00	47,00
	01.161 PT 71 UNIVERSAL overpanel connector, with fin on one side	219,00				256,00	281,00	305,00	305,00
	01.153 Sidelight connector with fixing plate (also for 12 mm glass)	81,50	81,50	104,00		102,00	112,00	115,00	115,00
	03.170 PT 80 UNIVERSAL connector	53,00				79,50	87,50	74,00	74,00
	03.175 PT 81 UNIVERSAL connector with fin on one side	231,00				278,00	305,00	324,00	324,00
	03.173 PT 62 UNIVERSAL connector with stop	53,00				79,50	87,00	74,00	74,00
	07.021 PT 90 UNIVERSAL screw-on fitting	20,00	20,00	41,50	63,00	41,50	45,00	32,00	32,00
	07.023 PT 91 UNIVERSAL corner fitting	30,00	30,00	48,00		48,00	52,50	43,50	43,50

Glass assemblies

For 10 mm glass thickness

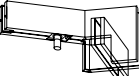

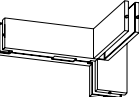
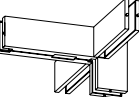
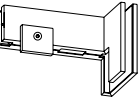
AL silver EV1 anod (101)    Satin stainl steel (700)    Polish stainl steel (701)    AL special color anod (199)    AL special color p-coat (399)

Art. No.	Description	€/Piece	€/Piece	€/Piece	€/Piece	€/Piece
	<b>03.161 PT 41 UNIVERSAL patch fitting for overpanel and sidelight, with fin fitting on both sides</b>	359,00	439,00	483,00	505,00	505,00
	<b>03.168 PT 41 UNIVERSAL patch fitting for overpanel and sidelight angle 135 – 179°, with fin on one side (please add drawing)</b>	- LH 585,00	676,00	744,00	819,00	819,00
	<b>03.169 do., (please add drawing)</b>	- RH 585,00	676,00	744,00	819,00	819,00
	<b>03.164 PT 42 UNIVERSAL overpanel patch with angled connector, with 90° angle</b>	- LH 447,00	520,00	574,00	627,00	627,00
	<b>03.165 do.</b>	- RH 447,00	520,00	574,00	627,00	627,00
	<b>03.464 PT 42 UNIVERSAL overpanel patch with angled connector, with 135° angle</b>	- LH 447,00	520,00	574,00	627,00	627,00
	<b>03.465 do.</b>	- RH 447,00	520,00	574,00	627,00	627,00
	<b>03.166 PT 42 UNIVERSAL overpanel patch with angled connector, angle 105 – 134°/136 – 179°</b>	- LH 447,00	560,00	574,00	627,00	627,00
	<b>03.167 do.</b>	- RH 447,00	560,00	574,00	627,00	627,00
	<b>03.160 PT 51 UNIVERSAL patch fitting for double overpanel with fin fitting on one side</b>	362,00	430,00	473,00	506,00	506,00
	<b>03.194 GK 41 UNIVERSAL strike-box with fin fitting on one side</b>	- LH 223,00	280,00	310,00	311,00	311,00
	<b>03.193 do.</b>	- RH 223,00	280,00	310,00	311,00	311,00
	<b>03.195 GK 41 UNIVERSAL strike-box with fin fitting on both sides</b>	359,00	439,00	483,00	505,00	505,00
	<b>03.274 GK 42 UNIVERSAL strike-box with angle at 90°, with stop inside</b>	- LH 447,00	520,00	574,00	627,00	627,00
	<b>03.275 do.</b>	- RH 447,00	520,00	574,00	627,00	627,00
	<b>03.276 GK 42 UNIVERSAL strike-box with angle at 135°</b>	- LH 447,00	520,00	574,00	627,00	627,00
	<b>03.277 do.</b>	- RH 447,00	520,00	574,00	627,00	627,00

Glass assemblies

**For 10 mm glass thickness**

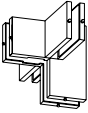
AL silver EV1 anod (101)	Satin stainl steel (700)	Polish stainl steel (701)	AL special color anod (199)	AL special color p-coat (399)
--------------------------	--------------------------	---------------------------	-----------------------------	-------------------------------





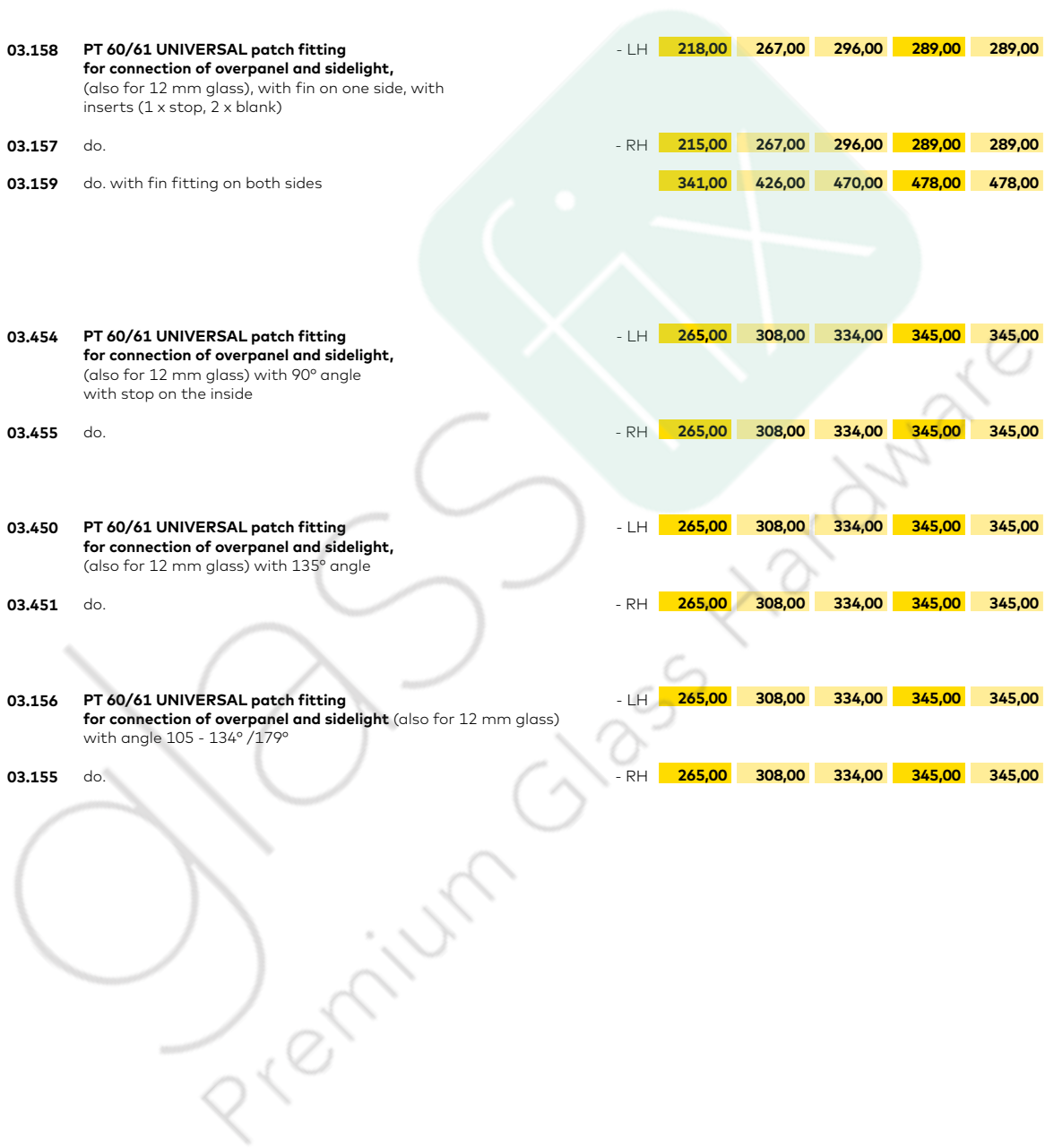

Art. No.	Description	€/Piece	€/Piece	€/Piece	€/Piece	€/Piece	
	<b>03.158</b> PT 60/61 UNIVERSAL patch fitting for connection of overpanel and sidelight, (also for 12 mm glass), with fin on one side, with inserts (1 x stop, 2 x blank)	- LH	218,00	267,00	296,00	289,00	289,00
	<b>03.157</b> do.	- RH	215,00	267,00	296,00	289,00	289,00
	<b>03.159</b> do. with fin fitting on both sides		341,00	426,00	470,00	478,00	478,00
	<b>03.454</b> PT 60/61 UNIVERSAL patch fitting for connection of overpanel and sidelight, (also for 12 mm glass) with 90° angle with stop on the inside	- LH	265,00	308,00	334,00	345,00	345,00
	<b>03.455</b> do.	- RH	265,00	308,00	334,00	345,00	345,00
	<b>03.450</b> PT 60/61 UNIVERSAL patch fitting for connection of overpanel and sidelight, (also for 12 mm glass) with 135° angle	- LH	265,00	308,00	334,00	345,00	345,00
	<b>03.451</b> do.	- RH	265,00	308,00	334,00	345,00	345,00
	<b>03.156</b> PT 60/61 UNIVERSAL patch fitting for connection of overpanel and sidelight (also for 12 mm glass) with angle 105 - 134° /179°	- LH	265,00	308,00	334,00	345,00	345,00
	<b>03.155</b> do.	- RH	265,00	308,00	334,00	345,00	345,00

Glass assemblies

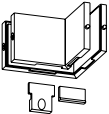



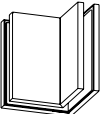



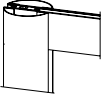
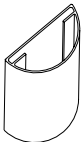

**For 10 mm glass thickness**

AL silver EV1 anod (101)    Satin stainl steel (700)    Polish stainl steel (701)    AL special color anod (199)    AL special color p-coat (399)

Art. No.	Description	€/Piece	€/Piece	€/Piece	€/Piece	€/Piece
	<b>01.156 PT 70 UNIVERSAL patch fitting for connection of overpanel and sidelight</b> (also for 12 mm glass) with inserts (2 x stop, 2 x blank) with 90° angle	259,00	294,00	315,00	330,00	330,00
	<b>01.157</b> do., with angle 135°	259,00	288,00	321,00	330,00	330,00
	<b>01.155</b> do., with angle 91 – 134°/136 – 179°	262,00	296,00		333,00	333,00
	<b>03.171 PT 80 UNIVERSAL connector with 90° angle</b>	270,00	315,00	345,00	379,00	379,00
	<b>03.470 PT 80 UNIVERSAL connector, shortened, with angle 90°</b>	180,00	227,00	248,00	252,00	252,00
	<b>03.172 PT 80 UNIVERSAL connector with 135° angle</b>	270,00	315,00	345,00	379,00	379,00
	<b>03.178 PT 80 UNIVERSAL connector, with angle 91 – 134°/136 – 179°</b>	298,00	345,00		416,00	416,00
	<b>03.179 PT 80 UNIVERSAL connector, shortened, with angle 91 – 134°/136 – 179°</b>	180,00	227,00		250,00	250,00
	<b>03.198 Three way box corner connector 90°</b>	432,00			582,00	582,00

Glass assemblies

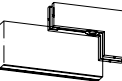
For 10 mm glass thickness

Art. No.	Description	Base parts (000)	AL silver EV1 anod (101)	AL traffic white p-coat (300)	Satin stain steel (700)	Polish stain steel (701)	AL special color anod (199)	AL special color p-coat (399)
		€/Piece	€/Piece	€/Piece	€/Piece	€/Piece	€/Piece	€/Piece
<b>Single components</b>								
<b>Pinch free with pivot point 65 mm</b>								
	<b>03.380 Round aluminium profile for pinch free doors</b> with 65 mm pivot point, consisting of 2 pieces, optionally prepared for: – UNIVERSAL fittings – 76.5 mm door rails – 100 mm door rails Please indicate: – Panel height (max. 2500 mm, higher dim. on request) – Required preparation of the profile for top and bottom fittings		301,00				421,00	421,00
	<b>Aluminium round profile</b> for pinch free doors with 65 mm pivot point, consisting of 2 pieces, (not prepared) each 6000 mm stock length		489,00				686,00	686,00
	<b>03.382</b> each 3000 mm stock length		251,00				380,00	380,00
	<b>03.383</b> each max. 2800 mm fixed length		93,50				133,00	133,00
	<b>Acrylic profile, clear</b> completely clamp free in stock length 2250 mm		57,50					
	<b>01.231</b> in fixed length upto 4500 mm		31,50					
<b>Pinch free with pivot point 15 mm</b>								
	<b>01.200</b> Bottom patch fitting for DORMA BTS		75,50		92,50	102,00	107,00	107,00
	<b>01.201</b> Bottom patch fitting with floor bearing		108,00		128,00	142,00	162,00	162,00
	<b>01.210</b> Top patch fitting with pivot pin		71,00		87,00	96,00	98,50	98,50
	<b>01.220</b> Overpanel fitting for pivot pin		52,50		73,50	80,00	79,50	79,50
	<b>01.240</b> Patch fitting for overpanel and sidelight for double action doors, for pivot pin		83,00		121,00	135,00	125,00	125,00
	<b>01.245</b> Patch fitting for overpanel and sidelight for pivot pin in combination with patch fittings		87,50		126,00	139,00	133,00	133,00
	<b>01.127</b> Fixing plate for overhead panel patch fitting		12,00	12,00		(501) 39,50	16,00	16,00



## For 13 – 19 mm glass thickness

Art. No.	Description	AL silver EV1 anod (101)	Satin stainl steel (700)	Polish stainl steel (701)	AL special color anod (199)	AL special color p-coat (399)
<b>Patch / Connection fittings for 13 - 19 mm TSG (please indicate glass thickness with the order)</b>						
03.280	PT 10 UNIVERSAL bottom patch fitting	66,50	89,00	96,00	94,50	94,50
03.281	PT 20 UNIVERSAL top patch fitting	64,00	87,50	94,50	93,00	93,00
03.282	PT 30 UNIVERSAL overpanel patch fitting with pivot insert Ø 15 mm	68,00	89,50	96,50	96,00	96,00
03.482	PT 30 UNIVERSAL overpanel patch fitting with stop insert	68,00	89,50	96,50	96,00	96,00
03.484	PT 30 UNIVERSAL overpanel patch fitting with blank insert	67,00	88,00	96,00	94,50	94,50
03.283	PT 40 UNIVERSAL patch fitting for overpanel and sidelight with pivot insert Ø 15 mm	85,50	119,00	130,00	130,00	130,00
03.483	PT 40 UNIVERSAL patch fitting for overpanel and sidelight with stop insert	85,50	119,00	130,00	130,00	130,00
03.485	PT 40 UNIVERSAL patch fitting for overpanel and sidelight with blank insert	84,00	118,00	128,00	128,00	128,00
03.452	PT 60/61 UNIVERSAL patch fitting for connection of overpanel and sidelight with inserts (1 x stop, 2 x blank)	64,00	104,00	110,00	89,50	89,50
01.158	PT 70 UNIVERSAL patch fitting for connection of overpanel and sidelight with inserts (2 x stop, 2 x blank)	58,50	77,00	84,50	87,00	87,00
03.472	PT 80 UNIVERSAL connector	55,50	83,50	91,50	77,50	77,50
07.210	PT 90 UNIVERSAL screw on fitting for 13.5 – 19 mm glass thickness	22,00	43,50	46,50	34,50	34,50
07.211	PT 91 UNIVERSAL corner fitting for 13.5 – 19 mm glass thickness	32,00	50,00	55,00	45,50	45,50
03.285	US 10 UNIVERSAL corner lock for 15, 19 mm glass	98,00	138,00	150,00	136,00	136,00
03.295	GK 30 UNIVERSAL overpanel strike box for 15, 19 mm glass	104,00	139,00	151,00	142,00	142,00
03.286	US 20 UNIVERSAL centre lock for 15, 19 mm glass	103,00	143,00	156,00	141,00	141,00
03.296	GK 50 UNIVERSAL strike box for 15, 19 mm glass	102,00	142,00	155,00	140,00	140,00

Gaskets

Base parts (000)

Art. No.	Description	€/Piece
<b>Gasket set for 12 mm glass thickness</b>		
03.900	for PT 10 / 20 / 22 / 29 / 30 und GK 30	3,10
03.901	for US 10 / 20 und GK 50	3,00
03.902	for PT 40 / 41 / 42 and GK 40 / 41 / 42	6,10
03.903	for PT 51	4,40
03.904	for PT 60 / 61 / 62	5,90
03.905	for PT 70 / 71	4,40
03.906	for PT 80 / 81	4,40
03.907	für PT 80 semi-high	4,40
03.908	for PT 90 / 91	2,80
03.909	for sidelight connector 01.153	5,10
03.910	for three way box corner connector 03.198	10,00
<b>Gasket set for 8 mm glass thickness</b>		
03.920	for PT 10 / 20 / 22 / 29 / 30 ud GK 30	3,10
03.921	for US 10 / 20 and GK 50	2,80
03.922	for PT 40 / 41 / 42 and GK 40 / 41 / 42	6,10
03.923	for PT 51	4,40
03.924	for PT 60 / 61 / 62	5,90
03.925	for PT 70 / 71	4,40
03.926	for PT 80 / 81	4,40
03.927	for PT 80 semi-high	4,40
03.928	for PT 90 / 91	2,80
03.929	for sidelight connector 01.153	5,10
03.930	for three way box corner connector 03.198	10,00

Glass assemblies

**Notes**



# UNIVERSAL Arcos



design award  
winner



reddot design award



Technical data	
Glass	TSG
Glass thickness	8, 10, 12 mm
Max. door weight	110 kg
Lock application	DORMA SG locks (non-lockable, profile cylinder, KABA cylinder), Patch locks
Applications	24 Standard types for toughened glass assemblies
Material	Aluminium, brass, stainless steel
Finishes	Anodised and RAL colors, brass, stainless steel
Specials	Suitable for outdoor assemblies Reddot and IF design award

24 Standard types for toughened glass assemblies

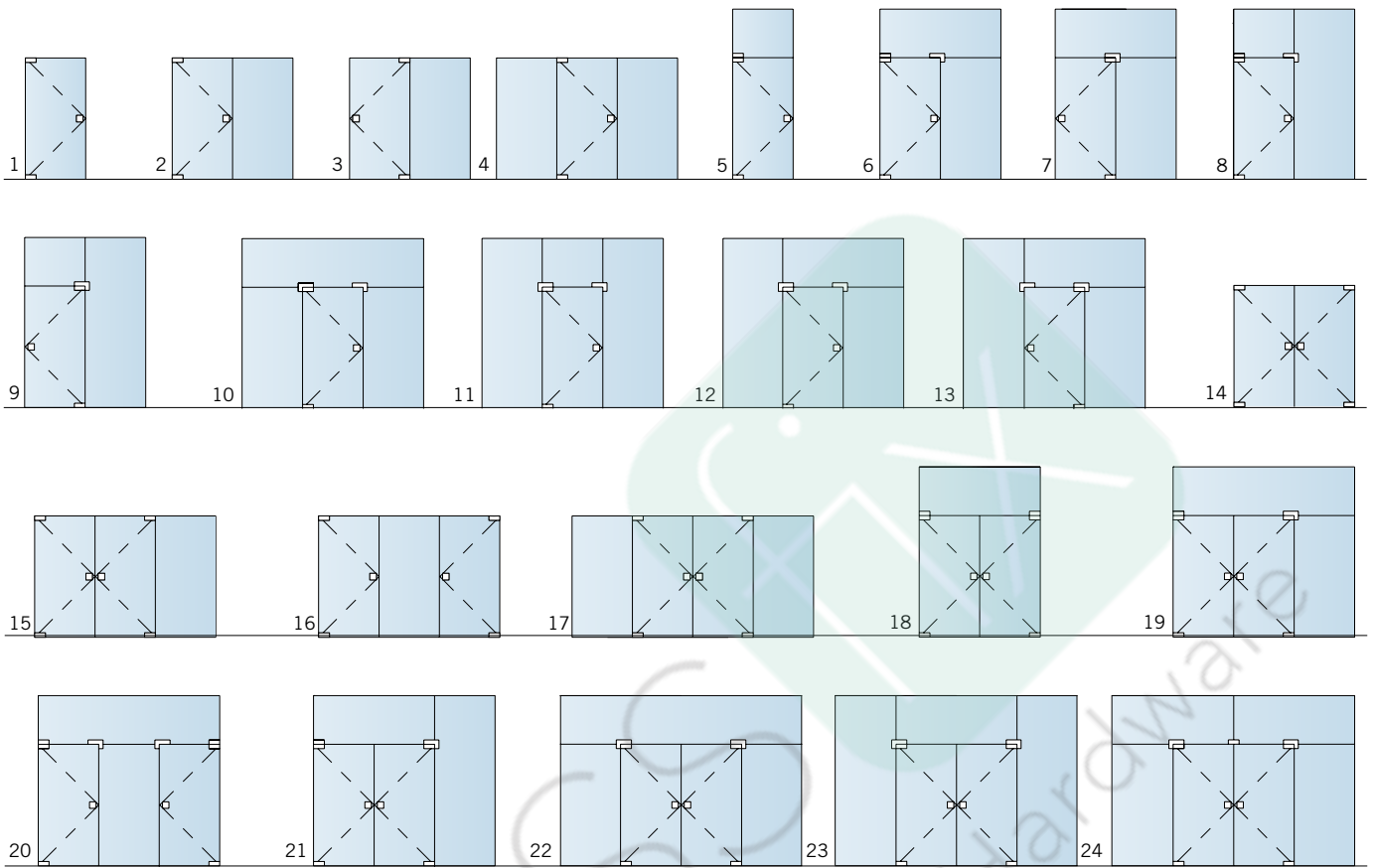

Example view for UNIVERSAL Arcos

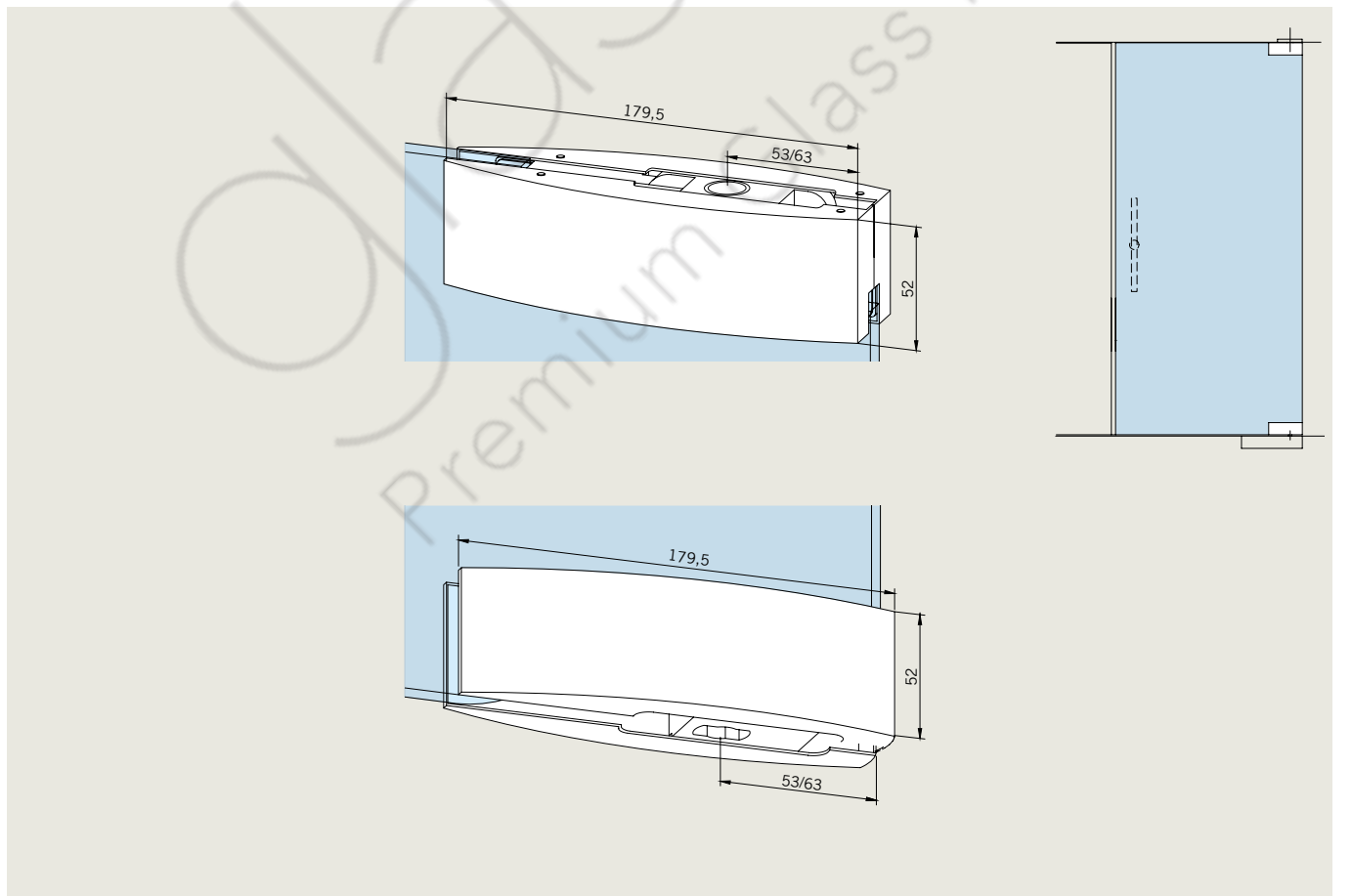









Glass assemblies

For 10 mm glass thickness

Art. No.	Description	Base parts (000)	AL EV1-Deco anod (114)	Satin stainl steel (700)	Polish stainl steel (701)	AL special color anod (199)	AL special color p-coat (399)
<b>Single components</b>							
<b>Patch fittings / Connectors</b>							
	26.100 PT 10 UNIVERSAL Arcos bottom patch fitting		72,00	102,00	114,00	101,00	101,00
	01.137 Floor pivot bearing for damp environments, with insert for UNIVERSAL for mounting onto floor surface max. door weight 80 kg		51,00				
	26.206 US 10 UNIVERSAL Arcos corner lock		114,00	166,00	184,00	159,00	159,00
	26.110 PT 20 UNIVERSAL Arcos top patch fitting		71,00	101,00	111,00	98,50	98,50
	26.112 PT 22 UNIVERSAL Arcos top patch fitting for RTS transom closer		110,00	142,00	158,00	155,00	155,00
	26.215 US 20 UNIVERSAL Arcos centre lock		119,00	174,00	192,00	167,00	167,00
	26.224 GK 50 UNIVERSAL Arcos strike-box		119,00	168,00	186,00	166,00	166,00
	26.120 PT 30 UNIVERSAL Arcos overpanel patch fitting with pivot insert ø 15 mm		74,00	104,00	115,00	103,00	103,00
	26.420 PT 30 UNIVERSAL Arcos overpanel patch fitting with stop insert		74,00	104,00	115,00	103,00	103,00
	26.421 PT 30 UNIVERSAL Arcos overpanel patch fitting with blank insert		72,00	102,00	114,00	102,00	102,00

**For 10 mm glass thickness**

Base parts (000)	AL EV1-Deco anod (114)	AL traffic white p-coat (300)	AL silver EV1 anod (101)	Satin stainl steel (700)	Polish stainl steel (701)	AL special color anod (199)	AL special color p-coat (399)
------------------	------------------------	-------------------------------	--------------------------	--------------------------	---------------------------	-----------------------------	-------------------------------

Art. No.	Description	€/Piece	€/Piece	€/Piece	€/Piece	€/Piece	€/Piece	€/Piece	€/Piece
	<b>26.230</b> GK 30 UNIVERSAL Arcos overpanel strike-box		119,00			168,00	186,00	166,00	166,00
	<b>26.245</b> GK 20 UNIVERSAL Arcos double overpanel strike-box, consisting of 2 x GK 30 with threaded rod		191,00			295,00	326,00	265,00	265,00
	<b>26.140</b> PT 40 UNIVERSAL Arcos patch fitting for overpanel and sidelight, with pivot insert ø 15 mm		96,50			144,00	158,00	136,00	136,00
	<b>26.440</b> PT 40 UNIVERSAL Arcos patch fitting for overpanel and sidelight, with stop insert		96,50			144,00	158,00	136,00	136,00
	<b>26.441</b> PT 40 UNIVERSAL Arcos patch fitting for overpanel and sidelight, with blank insert		95,50			143,00	157,00	135,00	135,00
	<b>26.250</b> GK 40 UNIVERSAL Arcos for overpanel and sidelight		144,00			204,00	227,00	198,00	198,00
	<b>03.128</b> Fixing plate for PT 30			9,30	9,30			13,00	13,00
	<b>01.133</b> Wall anchor, zinc plated for PT 30		7,10						
	<b>01.134</b> Threaded rod with wall plug, for PT 30		7,10						

Glass assemblies



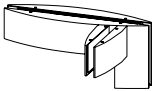
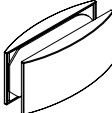

For 10 mm glass thickness

AL EV1-Deco anod (114)	Satin stainl steel (700)	Polish stainl steel (701)	AL special color anod (199)	AL special color p-coat (399)
---------------------------------	-----------------------------------	------------------------------------	---	---

Art. No.	Description		€/Piece	€/Piece	€/Piece	€/Piece	€/Piece
	<b>26.162</b> PT 41 UNIVERSAL Arcos patch fitting for overpanel and sidelight with fin fitting inside	- LH	256,00	329,00	364,00	357,00	357,00
	<b>26.163</b> do.	- RH	256,00	329,00	364,00	357,00	357,00
	<b>26.262</b> PT 41 UNIVERSAL Arcos patch fitting for overpanel and sidelight with stop insert	- LH	256,00	329,00	364,00	357,00	357,00
	<b>26.263</b> do.	- RH	256,00	329,00	364,00	357,00	357,00
	<b>26.264</b> PT 41 UNIVERSAL Arcos patch fitting for overpanel and sidelight with blank insert	- LH	256,00	329,00	364,00	357,00	357,00
	<b>26.265</b> do.	- RH	256,00	329,00	364,00	357,00	357,00
	<b>26.194</b> GK 41 UNIVERSAL Arcos strike-box with fin fitting inside	- LH	256,00	329,00	364,00	357,00	357,00
	<b>26.193</b> do.	- RH	256,00	329,00	364,00	357,00	357,00
	<b>12.536</b> Overpanel-sidepanel connector		36,50	<sup>(113)</sup> 43,50		47,00	47,00



Top pivot bearings

Art. No.	Description	Base parts (000)	AL silver EV1 anod (101)	AL traffic white p-coat (300)	Brass polish chromed (501) Polish stainl steel (701)	Satin stainl steel (700)	AL special color anod (199)	AL special color p-coat (399)
		€/Piece	€/Piece	€/Piece	€/Piece	€/Piece	€/Piece	€/Piece
	<b>01.117 PT 21 pivot</b> with retractable bolt	39,00						
	<b>01.118 PT 21.1 pivot</b> with retractable bolt incl. cover plate		42,50	42,50	45,00	45,00	53,00	53,00
	<b>01.116 PT 24 pivot</b> with fixing plate, material thickness 6 mm, to let into the ceiling		15,00	15,00			22,50	22,50
	<b>01.123 PT 24 pivot</b> with fixing plate, material thickness 3 mm, to screw on the ceiling		14,50	14,50		21,50	21,50	21,50
	<b>01.115 PT 25 pivot</b> with threaded rod	5,20						

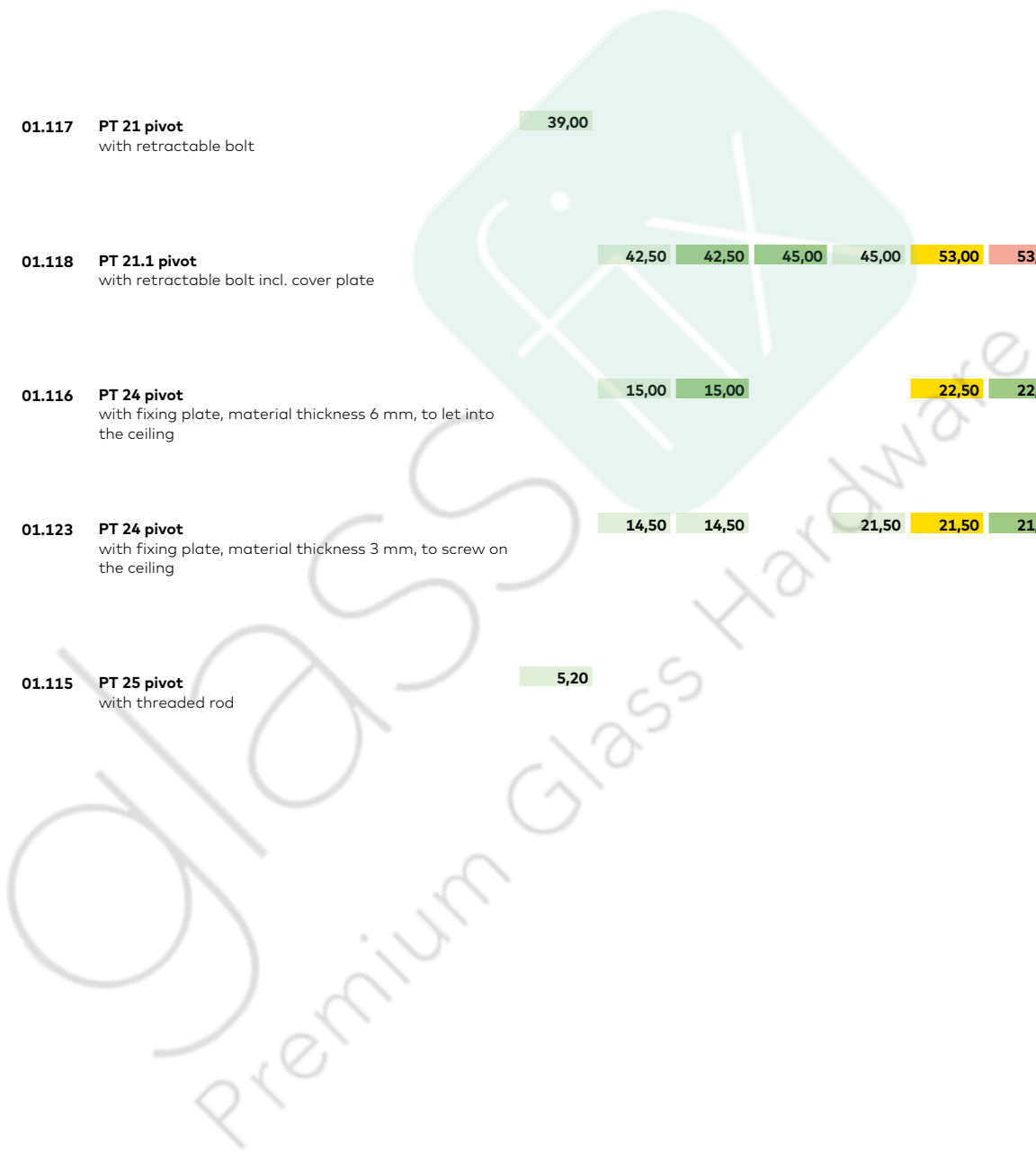

# UNIVERSAL light



Technical data	
Glass	TSG
Glass thickness	10, 12 mm
Max. door weight / door width	100 kg / 1100 mm
Lock application	Euro profile cylinder
Applications	Single/double leaf, sidelights, overpanels, toughened glass assembly
Material	Stainless steel
Finishes	Satin stainless steel, polished stainless steel
Specials	Tested acc. to EN 1154 with 200.000 operating cycles

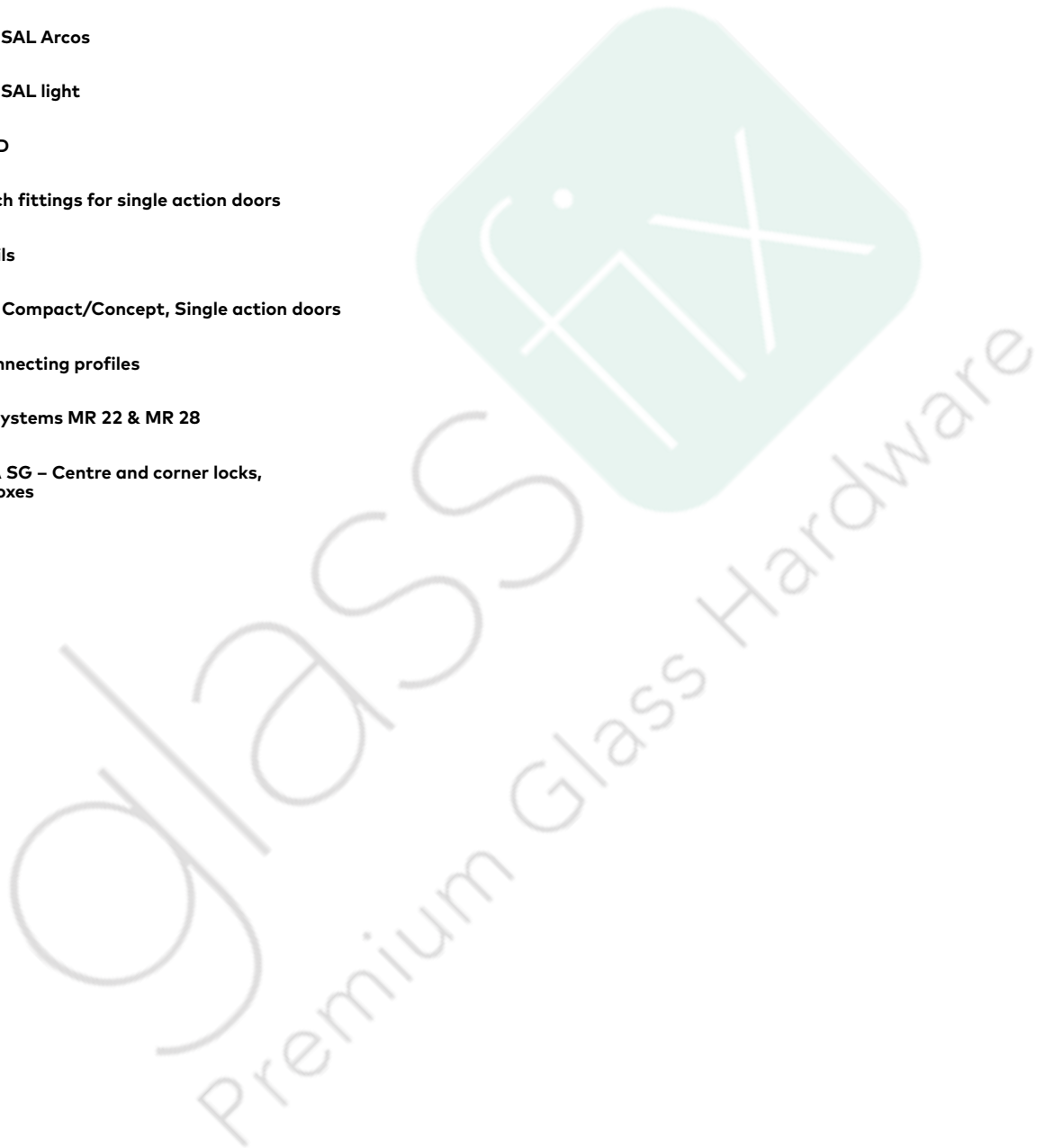

## Fittings for toughened glass assemblies

- |            |   |  |
|------------|---|--|
| <b>284</b> | <b>MUNDUS Comfort</b>                                   | <b>General accessories for toughened glass assemblies</b>                                |
| <b>294</b> | <b>MUNDUS Premium</b>                                   | <b>387</b> Clamping fitting, U-profile   |
| <b>304</b> | <b>UNIVERSAL</b>  | <b>388</b> Pivot bearing, floor bearing, strike plates, floor sockets, profile cylinders |
| <b>316</b> | <b>UNIVERSAL Arcos</b>                                  | <b>391</b> Locking unit for toughened glass assemblies                                   |
| <b>322</b> | <b>UNIVERSAL light</b>                                  |  |
| <b>326</b> | <b>BEYOND</b>   |  |
| <b>330</b> | <b>EA-Patch fittings for single action doors</b>        |  |
| <b>338</b> | <b>Door rails</b>                                       |  |
| <b>354</b> | <b>MANET Compact/Concept, Single action doors</b>       |  |
| <b>366</b> | <b>Wall connecting profiles</b>                         |  |
| <b>372</b> | <b>Frame systems MR 22 &amp; MR 28</b>                  |  |
| <b>376</b> | <b>DORMA SG – Centre and corner locks, strike boxes</b> |  |

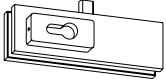
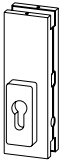
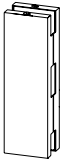
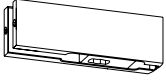
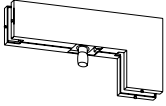

Single components

Satin  
stainl  
steel  
(700)      Polish  
stainl  
steel  
(701)

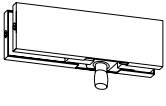
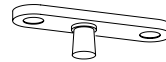
Art. No.	Description	€/Piece	€/Piece
	<b>03.608 UNIVERSAL US 10</b> corner lock	44,50	44,50
	<b>03.617 Universal US 20</b> centre lock	44,50	44,50
	<b>03.526 Universal GK 50</b> strike box	22,50	22,50
	<b>03.502 UNIVERSAL PT 10</b> bottom patch fitting	22,50	22,50
	<b>03.542 UNIVERSAL PT 40</b> patch fitting for overpanel with pivot insert Ø 15 mm	41,50	41,50
	<b>03.512 UNIVERSAL PT 20</b> top patch fitting	21,50	21,50
	<b>03.522 UNIVERSAL PT 30</b> overpanel patch fitting with pivot insert, Ø 15 mm	22,50	22,50
	<b>03.623 UNIVERSAL PT 24</b> Pivot with fixing plate, material thickness 3 mm, to screw on the brick work	8,50	8,50

Glass assemblies

UNIVERSAL light fittings are only available at ELC

Notes



# BEYOND



Technical data	
Glass	TSG
Glass thickness	10 and 12 mm
Max. door weight	80 kg
Lock application	DORMA SG
Applications	1-/2 panels, sidelight, overpanel, glass assembly
Material	Aluminium
Finishes	Anodised colors
Specials	Absolutely pinch free with continuous pivoting rod, Patented fitting system

## Fittings for toughened glass assemblies

- 284** MUNDUS Comfort
- 294** MUNDUS Premium
- 304** UNIVERSAL
- 316** UNIVERSAL Arcos
- 322** UNIVERSAL light
- 326** BEYOND
- 330** EA-Patch fittings for single action doors
- 338** Door rails
- 354** MANET Compact/Concept, Single action doors
- 366** Wall connecting profiles
- 372** Frame systems MR 22 & MR 28
- 376** DORMA SG – Centre and corner locks, strike boxes

### General accessories for toughened glass assemblies



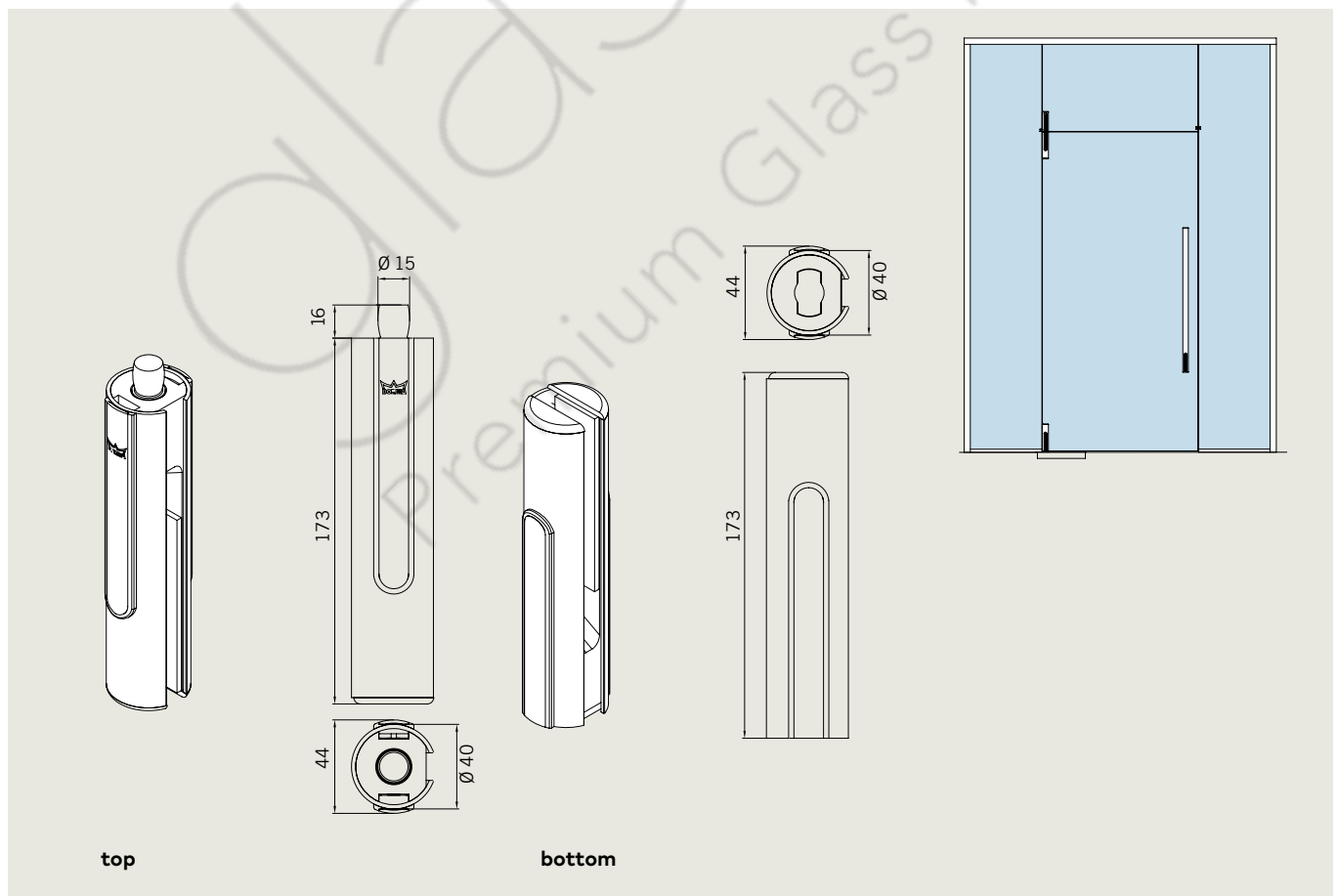

- 387** Clamping fitting, U-profile
- 388** Pivot bearing, floor bearing, strike plates, floor sockets, profile cylinders
- 391** Locking unit for toughened glass assemblies

### Example view for BEYOND



For 10 and 12 mm glass thickness

Base parts (000) AL EV1-Deco anod (114) AL sim satin stainl steel anod (107)

Art. No.	Description	€/Piece	€/Piece	€/Piece
<b>Complete sets</b>				
<b>Pivoting fitting set, short type</b>				
consisting of:				
1 top pivot fitting with pivot Ø 15 mm				
1 bottom pivot fitting with insert for DORMA floor spring spindle or round pivot				
	<b>30.100</b>	for 10 mm glass thickness	<b>256,00</b>	<b>312,00</b>
	<b>30.101</b>	for 12 mm glass thickness	<b>256,00</b>	<b>312,00</b>
<b>Pivoting fitting, long type,</b>				
with pivot Ø 15 mm at top and insert for DORMA floor spring spindle or round pivot at bottom				
	<b>30.110</b>	for 10 mm glass thickness (please indicate exact door height = glass measurement with order)	<b>289,00</b>	<b>351,00</b>
	<b>30.111</b>	for 12 mm glass thickness (please indicate exact door height = glass measurement with order)	<b>289,00</b>	<b>351,00</b>
<b>Single components</b>				
<b>BEYOND overpanel fitting, wall connector,</b>				
with plastic socket for top pivot				
	<b>30.120</b>	for 10 mm glass thickness	<b>121,00</b>	<b>148,00</b>
	<b>30.121</b>	for 12 mm glass thickness	<b>127,00</b>	<b>154,00</b>
<b>BEYOND overpanel fitting, glass connector,</b>				
with plastic socket for top pivot				
	<b>30.130</b>	for 10 mm glass thickness	<b>121,00</b>	<b>148,00</b>
	<b>30.131</b>	for 12 mm glass thickness	<b>127,00</b>	<b>154,00</b>
	<b>30.320</b>	<b>BEYOND overpanel fitting, glass connector,</b> with plastic socket for top pivot for 10 mm and 12 mm glass thickness	<b>17,50</b>	
<b>Anti-vibration device</b>				
	<b>30.034</b>	for 10 mm glass thickness	<b>9,30</b>	
	<b>30.035</b>	for 12 mm glass thickness	<b>9,30</b>	



Notes



# EA - Patch fittings for single action doors



Technical data	
Glass	TSG
Glass thickness	8, 10, 12 mm
Max. door weight	100 kg
Applications	1-/2 panels, sidelight, overpanel, glass assembly
Material	Aluminium, brass
Finishes	Anodised- and RAL-Colors (coated), brass
Specials	Door opening up to 180°, Applicable for semi-circular arch doors, Suitable for outdoor assemblies.

## Fittings for toughened glass assemblies

**284** MUNDUS Comfort

**294** MUNDUS Premium

**304** UNIVERSAL

**316** UNIVERSAL Arcos

**322** UNIVERSAL light

**326** BEYOND

**330** EA-Patch fittings for single action doors

**338** Door rails

**354** MANET Compact/Concept, Single action doors

**366** Wall connecting profiles

**372** Frame systems MR 22 & MR 28

**376** DORMA SG – Centre and corner locks, strike boxes

### General accessories for toughened glass assemblies

**387** Clamping fitting, U-profile

**388** Pivot bearing, floor bearing, strike plates, floor sockets, profile cylinders

**391** Locking unit for toughened glass assemblies

### Example view for EA - Patchfitting for single action doors

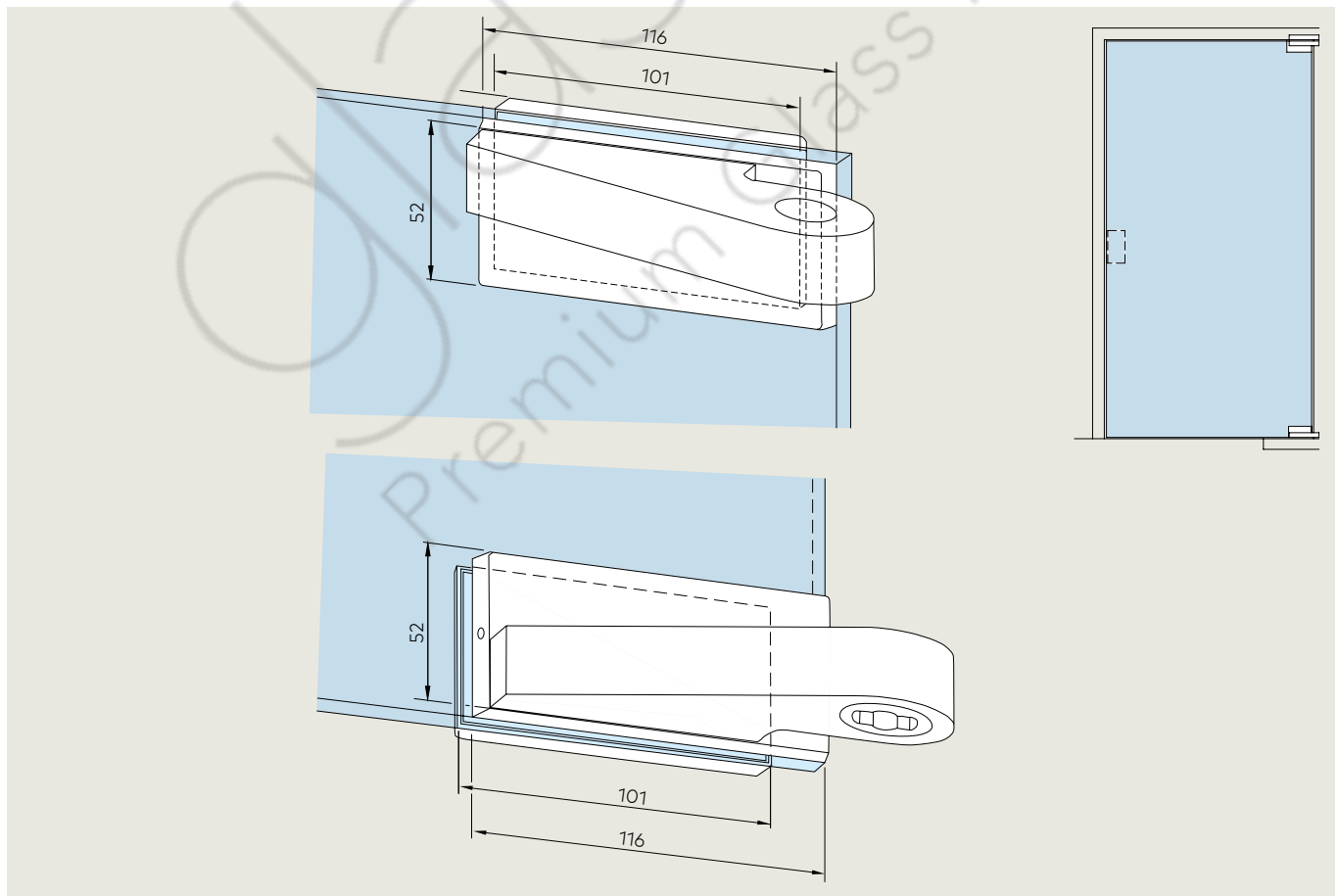







**Complete for 10 and 12 mm glass thickness, door strap 36 mm**

AL silver EV1 anod (101)    AL sim satin stainl steel anod (107)    Brass polished (503)    Brass polish chromed (501)    AL special color anod (199)    AL special color p-coat (399)

Art. No.	Description		€/Piece	€/Piece	€/Piece	€/Piece	€/Piece	€/Piece
<b>Patch fitting for single action doors without rebate, for 10 mm and 12 mm glass thickness</b>								
	<b>02.100</b> Bottom patch fitting	- LH	91,50	131,00	205,00	229,00	131,00	131,00
	<b>02.101</b> do.	- RH	91,50	131,00	205,00	229,00	131,00	131,00
	<b>02.110</b> Top patch fitting	- LH	89,00	127,00	204,00	226,00	127,00	127,00
	<b>02.111</b> do.	- RH	89,00	127,00	204,00	226,00	127,00	127,00
	<b>02.120</b> Overpanel patch fitting	- LH	98,00	141,00		231,00	141,00	141,00
	<b>02.121</b> do.	- RH	98,00	141,00		231,00	141,00	141,00
	<b>02.140</b> Patch fitting for overpanel and sidelight	- LH	116,00	166,00		246,00	166,00	166,00
	<b>02.141</b> do.	- RH	116,00	166,00		246,00	166,00	166,00
	<b>02.200</b> Top fitting with pivot for sidelight	- LH	193,00	277,00		384,00	277,00	277,00
	<b>02.201</b> do.	- RH	193,00	277,00		384,00	277,00	277,00
	<b>02.202</b> Top fitting with pivot for wall fixing	- LH	193,00	277,00		378,00	277,00	277,00
	<b>02.203</b> do.	- RH	193,00	277,00		378,00	277,00	277,00
	<b>02.204</b> Top fitting with pivot for frame fixing	- LH	193,00	277,00		384,00	277,00	277,00
	<b>02.205</b> do.	- RH	193,00	277,00		384,00	277,00	277,00



Glass assemblies

## Complete for 10 and 12 mm glass thickness, door strap 42 mm

		AL silver EV1 anod (101)	AL sim satin stainl steel anod (107)	Brass polished (503)	Brass polish chromed (501)	AL special color anod (199)	AL special color p-coat (399)
Art. No.	Description	€/Piece	€/Piece	€/Piece	€/Piece	€/Piece	€/Piece
<b>Patch fittings for single action doors with 24 mm rebate depth, for 10 mm glass thickness</b>							
	<b>02.102</b> Bottom patch fitting with counter-plate shortened at side	- LH 91,50	131,00	205,00	229,00	131,00	131,00
	<b>02.103</b> do.	- RH 91,50	131,00	205,00	229,00	131,00	131,00
	<b>02.104</b> Bottom patch fitting with counter-plate shortened at bottom and side	- LH 91,50	131,00	205,00	229,00	131,00	131,00
	<b>02.105</b> do.	- RH 91,50	131,00	205,00	229,00	131,00	131,00
	<b>02.112</b> Top patch fitting with counter-plate shortened at side	- LH 89,00	127,00	204,00	226,00	127,00	127,00
	<b>02.113</b> do.	- RH 89,00	127,00	204,00	226,00	127,00	127,00
	<b>02.114</b> Top patch fitting with counter-plate shortened at top and side	- LH 89,00	127,00	204,00	226,00	127,00	127,00
	<b>02.115</b> do.	- RH 89,00	127,00	204,00	226,00	127,00	127,00
	<b>02.122</b> Overpanel patch fitting with counter-plate shortened at side	- LH 89,00	127,00	204,00	226,00	127,00	127,00
	<b>02.123</b> do.	- RH 89,00	127,00	204,00	226,00	127,00	127,00
	<b>02.206</b> Top fitting with pivot for frame fixing, counter-plate shortened at side	- LH 193,00	277,00	348,00	384,00	277,00	277,00
	<b>02.207</b> do.	- RH 193,00	277,00	348,00	384,00	277,00	277,00

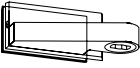
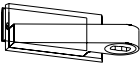

**Complete for 12 mm glass thickness, door strap 40 mm**

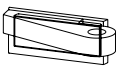
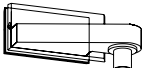
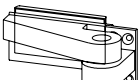
AL silver EV1 anod (101)	AL sim satin stainl steel anod (107)	Brass polish chromed (501)	AL special color anod (199)	AL special color p-coat (399)
-----------------------------------	--	-------------------------------------	---	---

Art. No.	Description		€/Piece	€/Piece	€/Piece	€/Piece	€/Piece
<b>Patch fittings for single action doors with 24 mm rebate depth, for 12 mm glass thickness</b>							
	<b>02.160</b> Bottom fitting with counter-plate shortened at side	- LH	102,00	150,00	265,00	150,00	150,00
	<b>02.161</b> do.	- RH	102,00	150,00	265,00	150,00	150,00
	<b>02.162</b> Bottom fitting with counter-plate shortened at bottom and side	- LH	102,00	150,00	265,00	150,00	150,00
	<b>02.163</b> do.	- RH	102,00	150,00	265,00	150,00	150,00
	<b>02.164</b> Top fitting with counter-plate shortened at side	- LH	95,50	142,00	262,00	142,00	142,00
	<b>02.165</b> do.	- RH	95,50	142,00	262,00	142,00	142,00
	<b>02.166</b> Top fitting with counter-plate shortened at top and side	- LH	95,50	142,00	262,00	142,00	142,00
	<b>02.167</b> do.	- RH	95,50	142,00	262,00	142,00	142,00
	<b>02.168</b> Overpanel with counter-plate shortened at side	- LH	106,00	157,00	263,00	157,00	157,00
	<b>02.169</b> do.	- RH	106,00	157,00	263,00	157,00	157,00
	<b>02.170</b> Top fitting with pivot for frame fixing, counter-plate shortened at side	- LH	205,00	295,00	396,00	295,00	295,00
	<b>02.171</b> do.	- RH	205,00	295,00	396,00	295,00	295,00

## Complete for 10 mm glass thickness, door strap 33 – 41 bzw. 43 – 58 mm

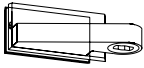
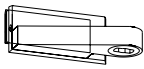

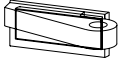
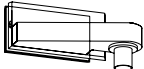
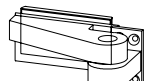

AL silver EV1 anod (101)	AL sim satin stainl steel anod (107)	Brass polish chromed (501)	AL special color anod (199)	AL special color p-coat (399)
-----------------------------------	--	-------------------------------------	---	---

Art. No.	Description		€/Piece	€/Piece	€/Piece	€/Piece	€/Piece	
<b>Patch fittings for single action doors with individual rebate depth (15 – 23 resp. 25 – 40 mm) for 10 mm glass thickness</b>								
	02.106	Bottom patch fitting with counter-plate shortened at side	- LH	104,00	150,00	269,00	150,00	150,00
	02.107	do.	- RH	104,00	150,00	269,00	150,00	150,00
	02.108	Bottom patch fitting with counter-plate shortened at side	- LH	104,00	150,00	264,00	150,00	150,00
	02.109	do.	- RH	104,00	150,00	264,00	150,00	150,00
	02.116	Top patch fitting with counter-plate shortened at side	- LH	101,00	146,00	263,00	146,00	146,00
	02.117	do.	- RH	101,00	146,00	263,00	146,00	146,00
	02.118	Top patch fitting with counter-plate shortened at top and side	- LH	101,00	146,00	262,00	146,00	146,00
	02.119	do.	- RH	101,00	146,00	262,00	146,00	146,00
	02.124	Overpanel with counter-plate shortened at side	- LH	108,00	157,00	267,00	157,00	157,00
	02.125	do.	- RH	108,00	157,00	267,00	157,00	157,00
	02.208	Top fitting with pivot for frame fixing, counter-plate shortened at side	- LH	215,00	348,00	426,00	348,00	348,00
	02.209	do.	- RH	215,00	348,00	426,00	348,00	348,00

Please specify glass thickness when ordering.

Door strap 36 mm

AL silver EV1 anod (101)    AL sim satin stainl steel anod (107)    Brass polished (503)    Satin stainl steel (700)    AL special color anod (199)    AL special color p-coat (399)

Art. No.	Description	€/Piece	€/Piece	€/Piece	€/Piece	€/Piece	€/Piece
<b>Frame top centres</b>							
	<b>02.150</b> Frame top centre with fixing block	52,00	75,50	139,00		76,00	76,00
	<b>02.151</b> Frame top centre with angle bracket	52,00	75,50	139,00		76,00	76,00
	<b>02.152</b> Frame top centre with special wedge screw fixings	- LH 52,00	75,50	139,00		76,00	76,00
	<b>02.153</b> do.	- RH 52,00	75,50	139,00		76,00	76,00
	<b>02.340</b> Top centre frame AT 21				- LH	32,50	
	<b>02.341</b> Top centre frame AT 21				- RH	32,50	

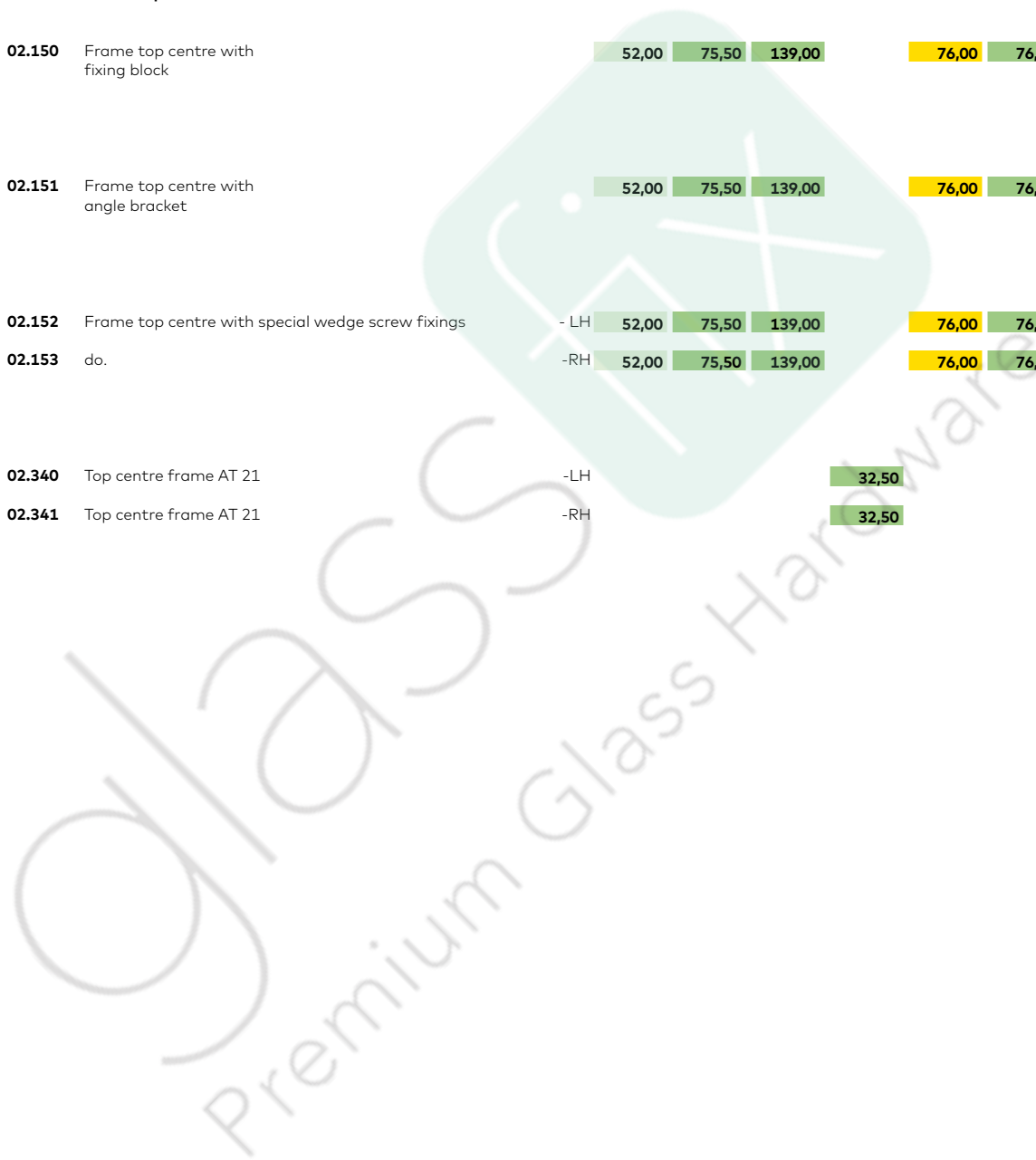

Glass assemblies



**Notes**



# Door rails



Technical data	
Glass	TSG
Glass thickness	8, 10, 12 mm
Max. door weight	150 kg
Lock application	Profile cylinder, KABA cylinder
Applications	1-/2 panels, sidelight, overpanel, toughened glass assembly
Material	Aluminium, stainless steel
Finishes	Anodised- and RAL-Colors (coated), brass, stainless steel
Specials	Combinable with EA- and Universal fittings. Suitable for outdoor assemblies. Variants for bullet-proof glass on request.

## Fittings for toughened glass assemblies

- 284** MUNDUS Comfort
- 294** MUNDUS Premium
- 304** UNIVERSAL
- 316** UNIVERSAL Arcos
- 322** UNIVERSAL light
- 326** BEYOND
- 330** EA-Patch fittings for single action doors
- 338** Door rails
- 354** MANET Compact/Concept, Single action doors
- 366** Wall connecting profiles
- 372** Frame systems MR 22 & MR 28
- 376** DORMA SG – Centre and corner locks, strike boxes

### General accessories for toughened glass assemblies

- 387** Clamping fitting, U-profile
- 388** Pivot bearing, floor bearing, strike plates, floor sockets, profile cylinders
- 391** Locking unit for toughened glass assemblies

### Example view for Door rails

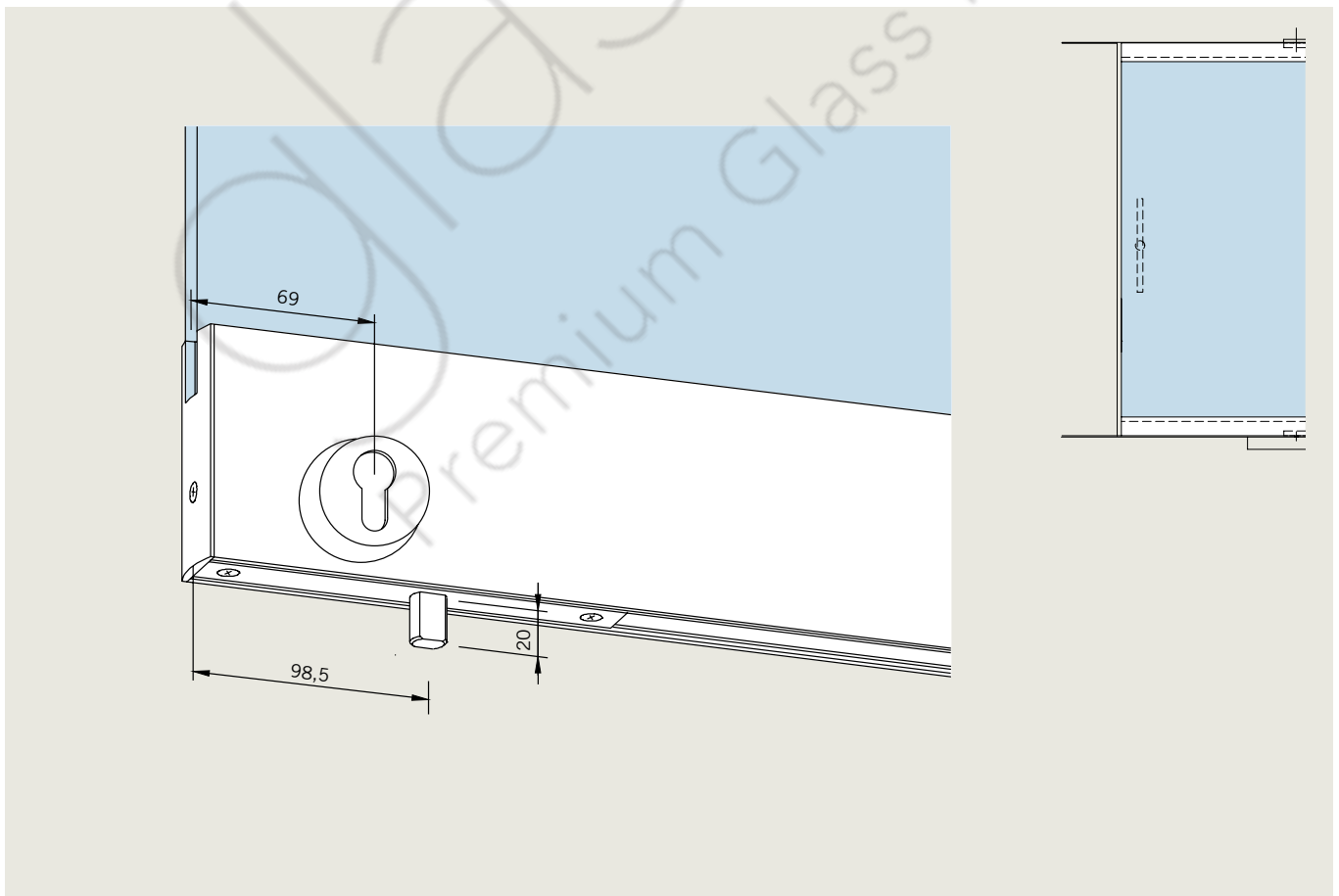

**100 mm high, for double action doors up to 1200 mm door width  
TP/TA, complete for 10 mm glass thickness as standard**

Art. No. bottom	Art. No. top	Description	AL mill finish (100) €/Piece	AL silver EV1 anod (101) €/Piece	AL traffic white p-coat (300) €/Piece	AL dark bronze DB 14 anod (108) €/Piece	Satin stainl steel (700) €/Piece	AL special color anod (199) €/Piece	AL special color p-coat (399) €/Piece
<b>Door rail, 100 mm high, for double action doors, without lock. Please indicate exact door width!</b>									
04.101	04.102	without lock, x = 55/65	211,00	227,00	227,00	252,00	362,00	310,00	310,00
04.103	04.104	without lock prepared for BTS with pin, x = 18	282,00	299,00	299,00	324,00	434,00	396,00	396,00
04.107		without lock prepared for floor bearing, x = 18	257,00	272,00	272,00	297,00	410,00	372,00	372,00
04.106		without lock prepared for RTS, x = 65	261,00	277,00	277,00	299,00	415,00	374,00	374,00
<b>Door rail, 100 mm high, for double action doors, with floor locking lock/top locking bolt lock Please indicate exact door width!</b>									
04.111	04.112	with bolt lock, x = 55/65	392,00	416,00	416,00	448,00	616,00	562,00	562,00
04.113	04.114	with bolt lock prepared for BTS with pin, x = 18	466,00	489,00	489,00	520,00	690,00	636,00	636,00
04.117		with bolt lock prepared for floor bearing, x = 18	440,00	463,00	463,00	496,00	664,00	608,00	608,00
04.116		with bolt lock prepared for RTS, x = 65	446,00	469,00	469,00	501,00	669,00	609,00	609,00
04.118		with latch lock, locking to ceiling, x = 55/65	477,00	485,00	485,00	522,00	689,00	618,00	618,00
<b>Door rail, 100 mm high, for double action doors, with side locking lock Please indicate exact door width!</b>									
04.121	04.122	with bolt lock, x = 55/65	394,00	417,00	417,00	449,00	617,00	548,00	548,00
04.123	04.124	with bolt lock prepared for BTS with pin, x = 18	469,00	491,00	491,00	523,00	691,00	638,00	638,00
04.127		with bolt lock prepared for floor bearing, x = 18	441,00	464,00	464,00	496,00	667,00	606,00	606,00
04.126		with bolt lock prepared for RTS, x = 65	447,00	471,00	471,00	502,00	671,00	611,00	611,00
			(000)	4,20					
		Surcharge per door rail for version 8 + 12 mm glass thickness							
		Other glass thicknesses are possible. Please see comment at the of this chapter.							

Glass assemblies

**100 mm high, for double action doors up to 1200 mm door width  
TP/TA, complete for 10 mm glass thickness as standard**

Art. No. bottom	Art. No. top	Description		Base parts (000)	AL mill finish (100)	AL silver EV1 anod (101)	AL traffic white p-coat (300)	AL dark bronze DB 14 anod (108)	Satin stainl steel (700)	AL special color anod (199)	AL special color p-coat (399)
				€/Piece	€/Piece	€/Piece	€/Piece	€/Piece	€/Piece	€/Piece	€/Piece
<p><b>Door rails, 100 mm high, for double action doors, with/for electric strike release</b> Please indicate exact door width!</p>											
04.191	04.192	with latch lock at side for electric strike release and floor/top locking bolt lock, x = 55/65	- LH	658,00	681,00	681,00	719,00	943,00	871,00	871,00	
04.193	04.194	do.	- RH	658,00	681,00	681,00	719,00	943,00	871,00	871,00	
04.196	04.197	with electric strike release and floor/top locking bolt lock, x = 55/65	- LH	631,00	653,00	653,00	685,00	865,00	831,00	831,00	
04.198	04.199	do.	- RH	631,00	653,00	653,00	685,00	865,00	831,00	831,00	
		Surcharge per door rail for version 8 + 12 mm glass thickness		4,20							

**100 mm high, for single action doors with 24 mm rebate depth, up to 1100 mm door width, door strap 40 mm TP/TA, complete for 10 mm glass thickness as standard**

Art. No. bottom	Art. No. top	Description	AL mill finish (100)	AL silver EV1 anod (101)	AL traffic white p-coat (300)	AL dark bronze DB 14 anod (108)	Satin stainl steel (700)	AL special color anod (199)	AL special color p-coat (399)		
			€/Piece	€/Piece	€/Piece	€/Piece	€/Piece	€/Piece	€/Piece		
<p><b>Door rails, 100 mm high, for single action doors with 24 mm rebate depth, without lock</b>                      color no. 700 = door strap in AL sim satin stainl steel anod C31 (113)                      Please indicate exact door width!</p>											
04.135	04.136	without lock, with free glass edge left and right	- LH	267,00	286,00	286,00	286,00	477,00	386,00	386,00	
04.137	04.138	do.	- RH	267,00	286,00	286,00	286,00	477,00	386,00	386,00	
04.139	04.140	without lock, with free glass edge at hanging side	- LH	258,00	275,00	275,00	275,00	458,00	374,00	374,00	
04.141	04.142	do.	- RH	258,00	275,00	275,00	275,00	458,00	374,00	374,00	
<p><b>Door rails, 100 mm high, for single action doors with 24 mm rebate depth, with lock</b>                      color no. 700 = door strap in AL sim satin stainl steel anod C31 (113)                      Please indicate exact door width!</p>											
04.155	04.156	with floor/top locking bolt lock and free glass edge left and right	- LH	452,00	477,00	477,00	477,00	730,00	623,00	623,00	
04.157	04.158	do.	- RH	452,00	477,00	477,00	477,00	730,00	623,00	623,00	
04.159	04.160	with floor/top locking bolt lock and free glass edge at hanging side	- LH	441,00	464,00	464,00	464,00	712,00	609,00	609,00	
04.161	04.162	do.	- RH	441,00	464,00	464,00	464,00	712,00	609,00	609,00	
04.175	04.176	with side locking bolt lock and free glass edge at hanging side	- LH	444,00	467,00	467,00	467,00	716,00	610,00	610,00	
04.177	04.178	do.	- RH	444,00	467,00	467,00	467,00	716,00	610,00	610,00	
				(000)	4,20						
				Surcharge per door rail for version 8 + 12 mm glass thickness							

**100 mm high, for single action doors with 24 mm rebate depth, up to 1100 mm door width, door strap 40 mm TP/TA, complete for 10 mm glass thickness as standard**

Base parts (000)	AL mill finish (100)	AL silver EV1 anod (101)	AL traffic white p-coat (300)	AL dark bronze DB 14 anod (108)	Satin stainl steel (700)	AL special color anod (199)	AL special color p-coat (399)
------------------	----------------------	--------------------------	-------------------------------	---------------------------------	--------------------------	-----------------------------	-------------------------------

Art. No. bottom	Art. No. top	Description		€/Piece	€/Piece	€/Piece	€/Piece	€/Piece	€/Piece	€/Piece	€/Piece
<p><b>Door rails, 100 mm high, for single action doors with 24 mm rebate depth, with/for electric strike release</b>                      color no. 700 = door strap in Alu. similar satin stainless steel C 31 (113).                      Please indicate exact door width!</p>											
04.143	04.144	with latch lock at side for electric strike release and floor/top locking bolt lock, free glass edge at hanging side	- LH	671,00	692,00	692,00	729,00	955,00	881,00	881,00	
04.145	04.146	do.	- RH	671,00	692,00	692,00	729,00	955,00	881,00	881,00	
04.147	04.148	with electric strike release at side and floor/top locking bolt lock, free glass edge at hanging side	- LH	640,00	664,00	664,00	696,00	877,00	843,00	843,00	
04.149	04.150	do.	- RH	640,00	664,00	664,00	696,00	877,00	843,00	843,00	
		Surcharge per door rail for version 8 + 12 mm glass thickness		4,20							

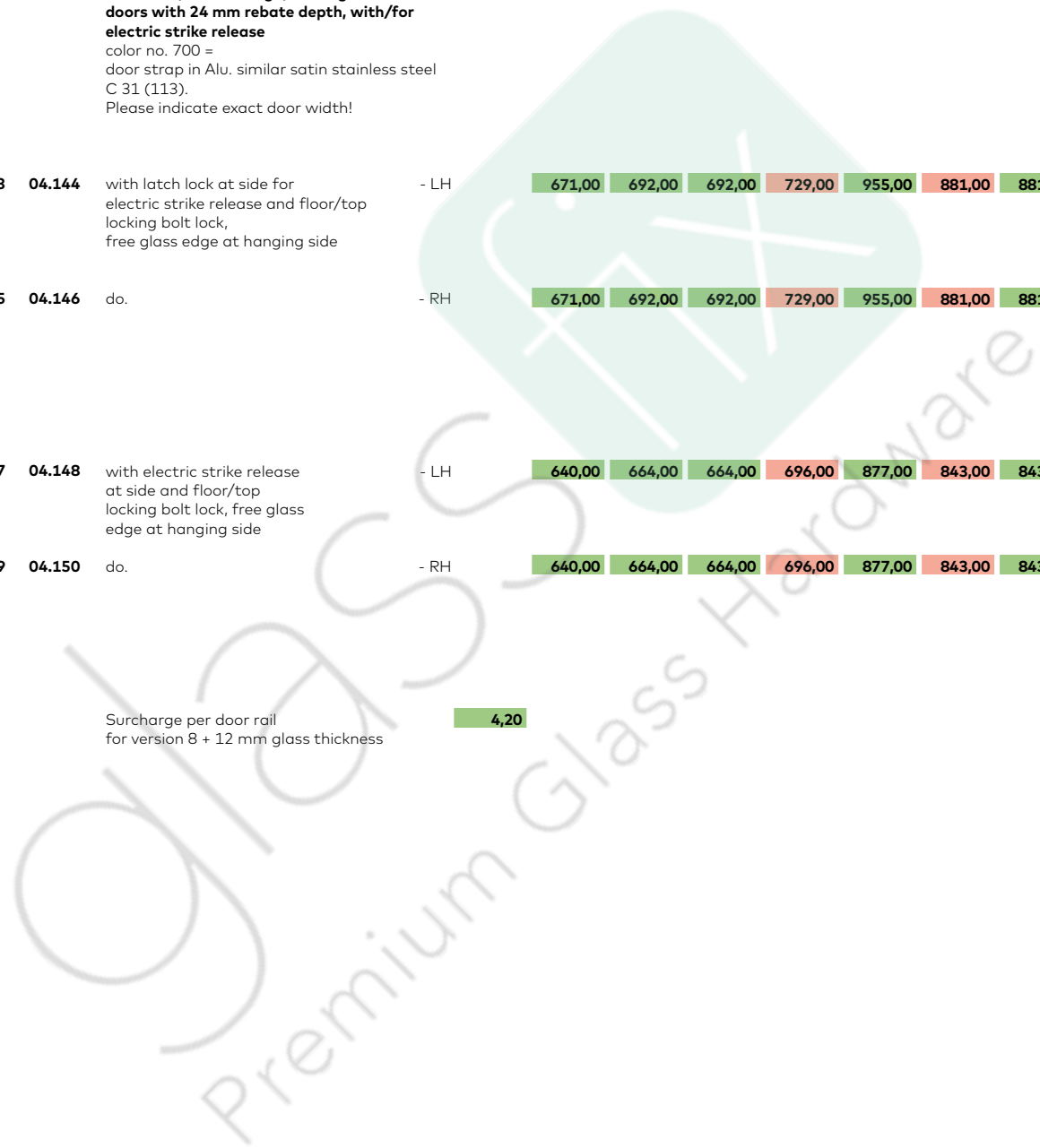

**100 mm high, for single action doors with 24 mm rebate depth, up to 1100 mm door width, door strap 34 mm, TP/TA, complete for 10 mm glass thickness as standard**

Art. No. bottom	Art. No. top	Description	AL mill finish (100)	AL silver EV1 anod (101)	AL traffic white p-coat (300)	AL dark bronze DB 14 anod (108)	Satin stainl steel (700)	AL special color anod (199)	AL special color p-coat (399)	
			€/Piece	€/Piece	€/Piece	€/Piece	€/Piece	€/Piece	€/Piece	
<p><b>Door rails, 100 mm high, for single action doors without rebate, without lock</b>                      color no. 700 =                      door strap in AL sim satin stainl steel anod C31 (113)                      Please indicate exact door width!</p>										
04.131	04.132	without lock	- LH	249,00	264,00	264,00	292,00	441,00	357,00	357,00
04.133	04.134	do.	- RH	249,00	264,00	264,00	292,00	441,00	357,00	357,00
<p><b>Door rails, 100 mm high, for single action doors without rebate, with lock</b>                      color no. 700 =                      door strap in AL sim satin stainl steel anod C31 (113)                      Please indicate exact door width!</p>										
04.151	04.152	with floor locking lock/top locking bolt lock	- LH	430,00	453,00	453,00	489,00	695,00	596,00	596,00
04.153	04.154	do.	- RH	430,00	453,00	453,00	489,00	695,00	596,00	596,00
04.171	04.172	with side locking bolt lock	- LH	432,00	449,00	449,00	490,00	696,00	598,00	598,00
04.173	04.174	do.	- RH	432,00	449,00	449,00	490,00	696,00	598,00	598,00
		Surcharge per door rail for version 8 + 12 mm glass thickness	(000)	4,20						



**100 mm high, for single action doors with 24 mm rebate depth, up to 1100 mm door width, door strap 34 mm, TP/TA, complete for 10 mm glass thickness as standard**

Base parts (000)	AL mill finish (100)	AL silver EV1 anod (101)	AL traffic white p-coat (300)	AL dark bronze DB 14 anod (108)	Satin stainl steel (700)	AL special color anod (199)	AL special color p-coat (399)
------------------	----------------------	--------------------------	-------------------------------	---------------------------------	--------------------------	-----------------------------	-------------------------------

Art. No. bottom	Art. No. top	Description		€/Piece	€/Piece	€/Piece	€/Piece	€/Piece	€/Piece	€/Piece	€/Piece
<p><b>Door rails, 100 mm high, for single action doors with 24 mm rebate depth, with/for electric strike release</b>                      color no. 700 = door strap in Alu. similar satin stainless steel C 31 (113)                      Please indicate exact door width!</p>											
04.179	04.180	with latch lock at side for electric strike release and with floor/top locking bolt lock	- LH	658,00	681,00	681,00	719,00	943,00	871,00	871,00	
04.181	04.182	do.	- RH	658,00	681,00	681,00	719,00	943,00	871,00	871,00	
04.183	04.184	with electric strike release at side and floor/top locking bolt lock	- LH	631,00	653,00	653,00	685,00	865,00	831,00	831,00	
04.185	04.186	do.	- RH	631,00	653,00	653,00	685,00	865,00	831,00	831,00	
		Surcharge per door rail for version 8 + 12 mm glass thickness		4,20							

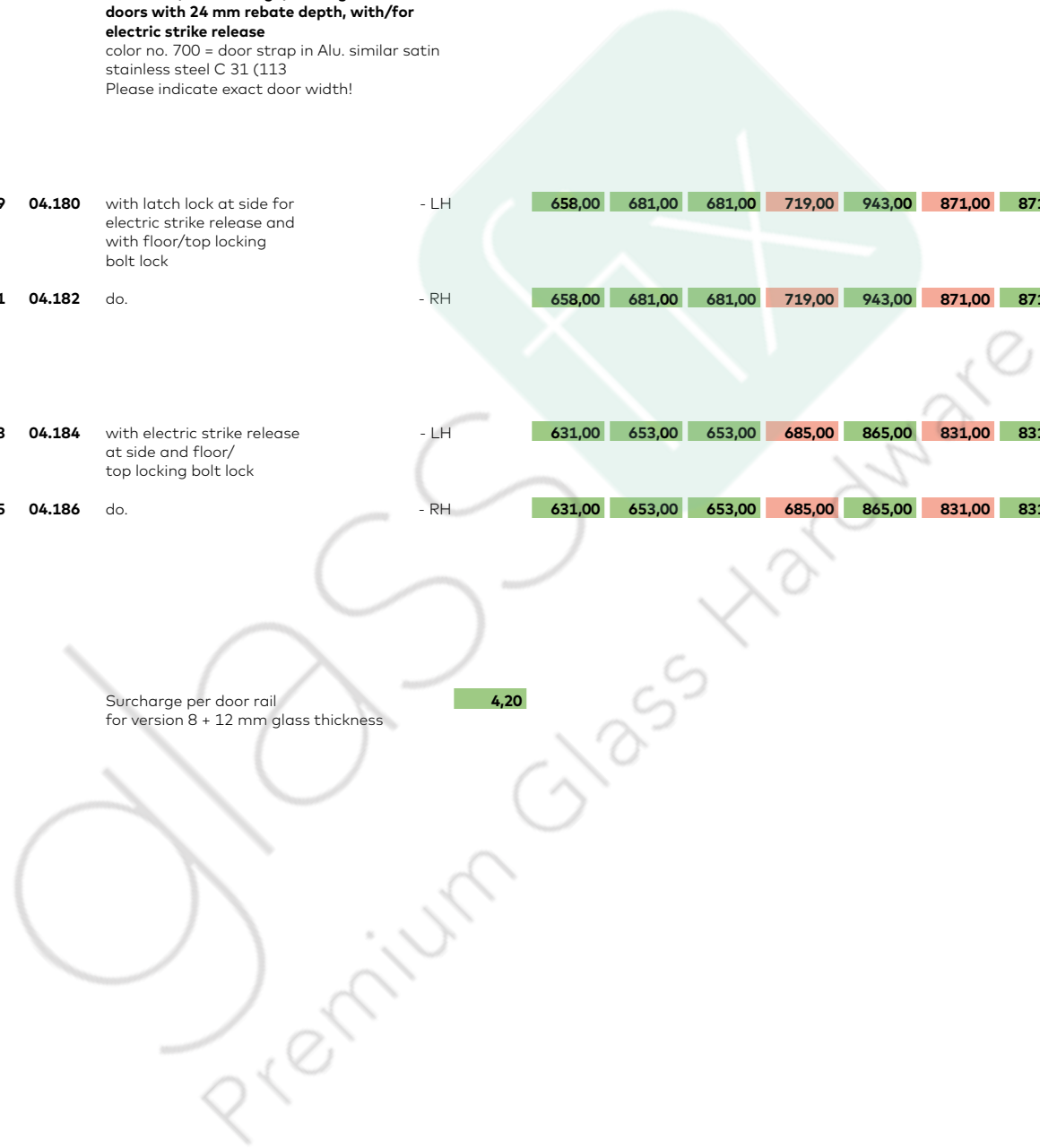

**100 mm high, for sidelights and sliding doors  
TP/TA, complete for 10 mm glass thickness as standard**

Art. No. bottom	Art. No. top	Description	Base parts (000)	AL mill finish (100)	AL silver EV1 anod (101)	AL traffic white p-coat (300)	AL dark bronze DB 14 anod (108)	Satin stainl steel (700)	AL special color anod (199)	AL special color p-coat (399)
			€/Piece	€/Piece	€/Piece	€/Piece	€/Piece	€/Piece	€/Piece	€/Piece
<b>Door rails, 100 mm high, for sidelights</b>										
Please indicate exact panel width!										
				€/m	€/m	€/m	€/m	€/m	€/m	€/m
04.301	04.302	with filler profile, top 3 mm, bottom 7 mm, up to 6000 mm length		202,00	220,00	220,00	248,00	338,00	305,00	305,00
04.311	04.312	with electric strike release, price for panel width up to 1200 mm (>1200 mm on request)	- LH	658,00	681,00	681,00	719,00	943,00	871,00	871,00
04.313	04.314	do.	- RH	658,00	681,00	681,00	719,00	943,00	871,00	871,00
04.315	04.316	with strike-box for side bolt locking, price for panel width up to 1200 mm (>1200 mm on request)		294,00	310,00	310,00	337,00	427,00	394,00	394,00
				4,20						
		Surcharge per door rail for version 8 + 12 mm glass thickness								
		Other glass thicknesses are possible. Please see comment at the of this chapter.								

**100 mm high, prepared for KABA cylinder, for double action doors up to 1200 mm door width TP/TA, complete for 10 mm glass thickness as standard**

Art. No. bottom	Art. No. top	Description	Base parts (000)	AL mill finish (100)	AL silver EV1 anod (101)	AL traffic white p-coat (300)	AL dark bronze DB 14 anod (108)	Satin stainl steel (700)	AL special color anod (199)	AL special color p-coat (399)
€ / Piece	€ / Piece	€ / Piece	€ / Piece	€ / Piece	€ / Piece	€ / Piece	€ / Piece	€ / Piece	€ / Piece	€ / Piece
<p><b>Door rails, 100 mm high, for double action doors, for floor locking and ceiling locking, prepared for KABA cylinder</b> Please indicate exact door width!</p>										
04.163	04.164	with bolt lock, x = 55/65		415,00	439,00	439,00	471,00	639,00	582,00	582,00
04.165	04.166	with bolt lock, prepared for BTS, x = 18		489,00	513,00	513,00	544,00	712,00	657,00	657,00
04.168		with bolt lock, prepared for floor bearing, x = 18		462,00	485,00	485,00	518,00	686,00	633,00	633,00
04.167		with bolt lock, prepared for RTS, x = 65		467,00	490,00	490,00	522,00	690,00	633,00	633,00
		Surcharge per door rail for version 8 + 12 mm glass thickness		4,20						
		Other glass thicknesses are possible. Please see comment at the of this chapter.								
		<b>Single action doors with locking lock prepared for KABA cylinder on request!</b>								

**76.5 mm high, for double action doors up to 1200 mm door width  
TP/TA, complete for 10 mm glass thickness as standard**

Art. No. bottom	Art. No. top	Description	Base parts (000) €/Piece	AL mill finish (100) €/Piece	AL silver EV1 anod (101) €/Piece	AL traffic white p-coat (300) €/Piece	AL dark bronze DB 14 anod (108) €/Piece	Satin stainl steel (700) €/Piece	AL special color anod (199) €/Piece	AL special color p-coat (399) €/Piece
<b>Door rails, 76.5 mm high, for double action doors, without lock</b> Please indicate exact door width!										
04.001	04.002	without lock, x = 55/65	179,00	194,00	194,00	218,00	320,00	271,00	271,00	
04.003	04.004	without lock, prepared for BTS, x = 18	253,00	267,00	267,00	292,00	392,00	358,00	358,00	
04.007		without lock, prepared for floor bearing, x = 18	227,00	243,00	243,00	264,00	367,00	332,00	332,00	
04.006		without lock, prepared for RTS, x = 65	230,00	248,00	248,00	278,00	374,00	334,00	334,00	
<b>Door rails, 76.5 mm high, for double action doors, with floor locking lock/top locking PZ bolt lock</b> Please indicate exact door width!										
04.011	04.012	with bolt lock, x = 55/65	361,00	385,00	385,00	501,00	572,00	520,00	520,00	
04.013	04.014	with bolt lock, prepared for BTS, x = 18	434,00	458,00	458,00	590,00	646,00	596,00	596,00	
04.017		with bolt lock, prepared for floor bearing, x = 18	408,00	432,00	432,00	458,00	618,00	567,00	567,00	
04.016		with bolt lock, prepared for RTS, x = 65	414,00	438,00	438,00	464,00	624,00	567,00	567,00	
		Surcharge per door rail for version 8 + 12 mm glass thickness	4,20							

**76.5 mm high, for single action doors with 24 mm rebate depth up to 1100 mm door width, door strap 40 mm, TP/TA, complete for 10 mm glass thickness as standard**

Art. No. bottom	Art. No. top	Description		Base parts (000)	AL mill finish (100)	AL silver EV1 anod (101)	AL traffic white p-coat (300)	AL dark bronze DB 14 anod (108)	Satin stainl steel (700)	AL special color anod (199)	AL special color p-coat (399)
				€/Piece	€/Piece	€/Piece	€/Piece	€/Piece	€/Piece	€/Piece	€/Piece
<p><b>Door rails, 76.5 mm high, for single action doors with 24 mm rebate depth, without lock</b>                      color no. 700 = door strap in Alu. similar satin stainless steel C 31                      Please indicate exact door width!</p>											
04.035	04.036	with free glass edge left and right	- LH	237,00	256,00	256,00	281,00	433,00	347,00	347,00	
04.037	04.038	do.	- RH	237,00	256,00	256,00	281,00	433,00	347,00	347,00	
04.039	04.040	with free glass edge at hanging side	- LH	228,00	244,00	244,00	270,00	416,00	334,00	334,00	
04.041	04.042	do.	- RH	228,00	244,00	244,00	270,00	416,00	334,00	334,00	
<p><b>Door rails, 76.5 mm high, for single action doors with 24 mm rebate depth, with lock</b>                      color no. 700 = door strap in Alu. similar satin stainless steel C 31                      Please indicate exact door width!</p>											
04.055	04.056	with floor/top locking bolt lock and free glass edge left and right	- LH	420,00	444,00	444,00	477,00	686,00	580,00	580,00	
04.057	04.058	do.	- RH	420,00	444,00	444,00	477,00	686,00	580,00	580,00	
04.059	04.060	with floor/top locking bolt lock and free glass edge at hanging side	- LH	411,00	433,00	433,00	464,00	668,00	567,00	567,00	
04.061	04.062	do.	- RH	411,00	433,00	433,00	464,00	668,00	567,00	567,00	
		Surcharge per door rail for version 8 + 12 mm glass thickness		4,20							

Glass assemblies

**76.5 mm high, for single action doors without rebate, up to 1200 mm door width, door strap 34 mm; door rails for sidelights, TP/TA, complete for 10 mm glass thickness as standard**





Art. No. bottom	Art. No. top	Description		Base parts	AL	AL	AL	AL	Satin	AL	AL
				(000)	mill finish (100)	silver EV1 anod (101)	traffic white p-coat (300)	dark bronze DB 14 anod (108)	stainl steel (700)	special color anod (199)	special color p-coat (399)
				€/Piece	€/Piece	€/Piece	€/Piece	€/Piece	€/Piece	€/Piece	€/Piece
<p><b>Door rails, 76.5 mm high, for single action doors without rebate, without lock</b>                      color no. 700 = door strap in Alu. similar satin stainless steel C 31 (113),                      Please indicate exact door width!</p>											
04.031	04.032	without lock	- LH	217,00	233,00	233,00	258,00	396,00	319,00	319,00	
04.033	04.034	do.	- RH	217,00	233,00	233,00	258,00	396,00	319,00	319,00	
<p><b>Door rails, 76.5 mm high, for single action doors without rebate, with lock</b>                      color no. 700 = door strap in Alu. similar satin stainless steel C 31,                      Please indicate exact door width!</p>											
04.051	04.052	with floor locking lock/ top locking bolt lock	- LH	400,00	422,00	422,00	452,00	649,00	553,00	553,00	
04.053	04.054	do.	- RH	400,00	422,00	422,00	452,00	649,00	553,00	553,00	
<p><b>Door rails for side lights, 76,5 mm high</b>                      Please indicate exact door width!</p>											
04.201	04.202	with bottom filler profile, top 3 mm, bottom 7 mm, up to 6000 mm length		172,00	189,00	189,00	216,00	296,00	266,00	266,00	
		Surcharge per door rail for version 8 + 12 mm glass thickness		4,20							

**76.5 mm high, for double action doors up to 1200 mm door width  
TP/TA, complete for 10 mm glass thickness as standard**

Art. No. bottom	Art. No. top	Description	Base parts (000)	AL mill finish (100)	AL silver EV1 anod (101)	AL traffic white p-coat (300)	AL dark bronze DB 14 anod (108)	Satin stainl steel (700)	AL special color anod (199)	AL special color p-coat (399)
			€/Piece	€/Piece	€/Piece	€/Piece	€/Piece	€/Piece	€/Piece	€/Piece
<p><b>Door rails, 76.5 mm high, for double action doors with floor/top locking bolt lock prepared for KABA cylinder</b> Please indicate exact door width!</p>										
04.063	04.064	with bolt lock, x = 55/65	383,00	407,00	407,00	522,00	594,00	544,00	544,00	
04.065	04.066	with bolt lock, prepared for BTS, x = 18	457,00	481,00	481,00	610,00	668,00	618,00	618,00	
04.068		with bolt lock, prepared for floor bearing, x = 18	430,00	453,00	453,00	482,00	642,00	586,00	586,00	
04.067		with bolt lock, prepared for RTS, x = 65	434,00	458,00	458,00	487,00	646,00	586,00	586,00	
		Surcharge per door rail for version 8 + 12 mm glass thickness		4,20						

**Single action doors with locking bolt lock prepared for KABA cylinder on request!**

**Accessories for door rails**  
**Special glass thicknesses TP/TA**

Art. No. bottom	Art. No. top	Description	Base parts (000) €/Piece	AL mill finish (100) €/Piece	AL silver EV1 anod (101) AL traffic white p-coat (300) €/Piece	AL dark bronze DB 14 anod (108) €/Piece	AL sim satin stainl steel anod C31 (113) €/Piece	AL special color anod (199) €/Piece
<b>Spare parts</b>								
	04.600	04.600	Bottom brush profile for door rail, price for door width up to 1200 mm > 1200 mm on request	71,00				
	04.604		Insert for roof rails for BTS and floor-bearing, stainless steel	19,50				
	04.605		Bottom strap in forged steel, assembled in door rails for double action doors – normal frequented doors, max. door weight 150 kg, max. door width 1400 mm – high frequented doors, max. door weight 120 kg, max. door width 1200 mm x = 55/65 mm (Please indicate)	57,50				
	04.606		Top insert, two-piece for top door rail (easier installation)	35,50				
	04.607		Rubber sealing for door rails fixed length	€/m 3,40				
	04.608		do., stock length 200 m (= 1 roll)	€/m 2,90				
	04.950		Surcharge for one sided mitre-cut	37,50				
	01.136		Screw-on floor bearing moistureproof, compl. with insert for door rails, max. 100 kg	58,50				
<p><b>Surcharge for glass thickness 13.5 / 15 / 17 / 19 / 21 mm possible only for toughened/laminated glass! Please indicate glass thickness!</b></p> <p><b>This option only applies to 100 mm door rails for double action doors or sidelights. Not possible for door rails with side latch lock and electric strike release.</b></p>								
	04.760		Surcharge for bottom rails complete with bottom strap No. 04.048.001.50 x = 55 or 65 mm (Please indicate)	133,00				
	04.761		Surcharge for top door rails	81,00				
	04.762		Surcharge for sidelight door rails	€/m 81,00				
			Surcharge for door rails for bullet-proof glass (laminated glass with float glass) on request (possible for 13.5 – 30 mm glass thickness)					
	04.900	04.900	Surcharge for changed lever due to rebate depth different from 24 mm (max. door weight 80 kg, max. door width 1000 mm)		9,40	11,00	14,00	<sup>(700)</sup> 36,00 16,00

Glass assemblies



**Notes**



# MANET



**Attention:** The products in this chapter are not allowed for structural glazings requiring approval in each individual case.



reddot design award



Technical data	
Glass	TSG (Compact), TSG and LSG (2 x TSG) (Concept)
Glass thickness	10, 12 mm (COMPACT) 10 - 15,5 mm (CONCEPT)
max. door panel weight	80 Kg (COMPACT) 100 Kg (CONCEPT)
Applications	MANET locks
Material	1-/2-panels, sidelight, overpanel, toughened glass assembly
Finishes	Stainless steel AISI 303 (stainless steel AISI 316 on request), (not for indoor swimming pools or salt-water pools)
Kind of installation	Satin stainless steel
Specials	Readjustable without dismantling +2,5/-2,5 mm

## Fittings for toughened glass assemblies

- 284** MUNDUS Comfort
- 294** MUNDUS Premium
- 304** UNIVERSAL
- 316** UNIVERSAL Arcos
- 322** UNIVERSAL light
- 326** BEYOND
- 330** EA-Patch fittings for single action doors
- 338** Door rails
- 354** MANET Compact/Concept, Single action doors
- 366** Wall connecting profiles
- 372** Frame systems MR 22 & MR 28
- 376** DORMA SG – Centre and corner locks, strike boxes

### General accessories for toughened glass assemblies

- 387** Clamping fitting, U-profile
- 388** Pivot bearing, floor bearing, strike plates, floor sockets, profile cylinders
- 391** Locking unit for toughened glass assemblies

### Example view for MANET

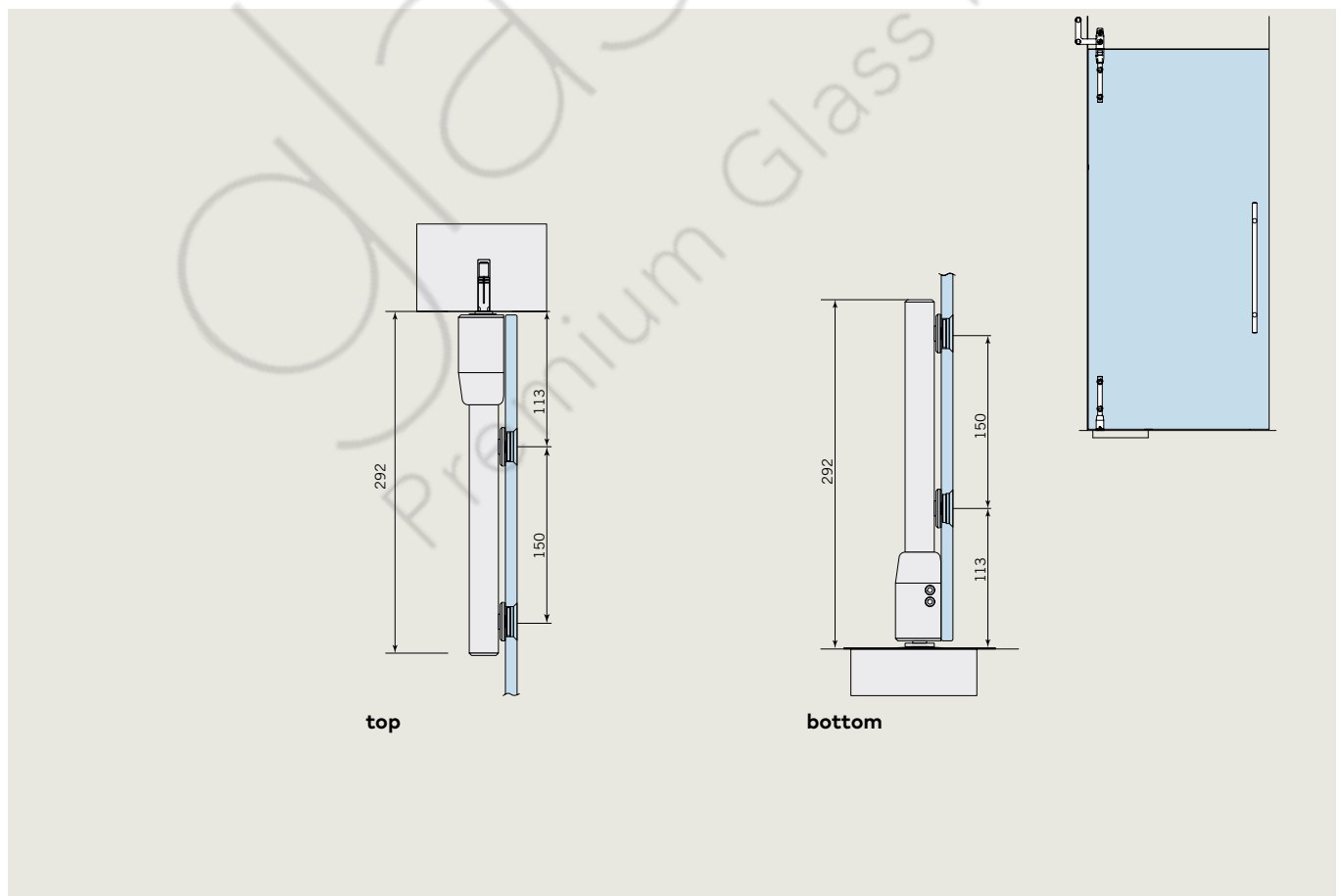

Set 1

Satin  
stainl  
steel  
(700)

Art. No.	Description	€/Piece
----------	-------------	---------

Complete sets

Pivot door MANET COMPACT without overpanel for 10 – 12 mm glass



**29.910** Set 1 with **countersunk** single-point fixings  
consisting of:  
Pair of top/bottom pivot poles, short type  
  
incl.:  
4 Single-point fixings for pivot poles,  
1 Top pivot bearing,  
1 PT 25 pivot 15 mm Ø with plug  
1 Bottom pivot bearing for  
DORMA BTS and floor bearing

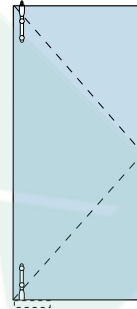

296,00

**29.911** Set as above, but for additional connecting tube in fixed length for pair of top/bottom pivot poles with countersunk single-point fixings

310,00



**29.555** **Not covered by the set:**  
Connecting tube in fixed length  
Length to be indicated when ordering.  
Calculation of fixed length:  
  
Panel height \_\_\_\_\_ mm  
- 577 mm  
= Length of connecting tube  
\_\_\_\_\_ mm

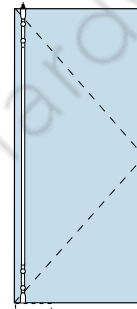

€/m  
35,00

Application example for SET 1

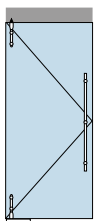

Assembly type 1

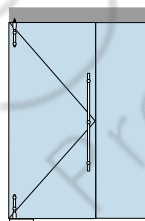

Assembly type 2

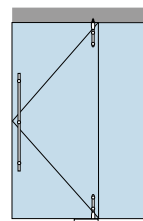

Assembly type 3

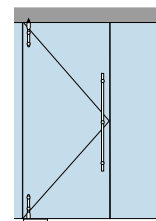

Assembly type 4

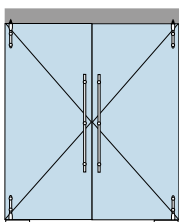

Assembly type 5

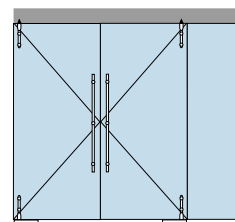

Assembly type 6

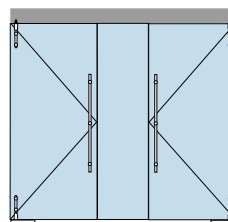

Assembly type 7

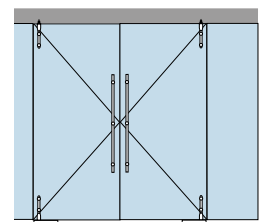

Assembly type 8

Set 2

Satin  
stainl  
steel  
(700)

Art. No.	Description	€/Piece
----------	-------------	---------

Complete sets

Pivot door MANET COMPACT with overpanel for 10 – 12 mm glass



**29.912** Set 2 with **countersunk** single-point fixings

consisting of:  
Pair of top/bottom pivot poles, short type

incl.:  
4 Single-point fixings for pivot poles,  
1 Top pivot bearing,  
1 Pivot bearing location for overpanel,  
1 Bottom pivot bearing for DORMA BTS and floor bearing

362,00



**29.913** Set as above, but for additional connecting tube in fixed length for pair of top/bottom pivot poles with countersunk single-point fixings

381,00



**29.555** **Not covered by the set:**  
Connecting tube in fixed length  
Length to be indicated when ordering.  
Calculation of fixed length:

Panel height \_\_\_\_\_ mm  
- 577 mm  
= Length of connecting tube  
\_\_\_\_\_ mm

€/m  
35,00

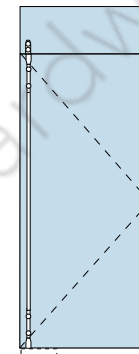

Application example for SET 2

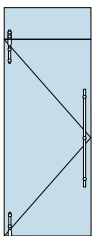

Assembly type 9

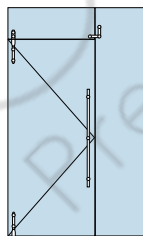

Assembly type 12  
+ 1 Overpanel sidelight connector

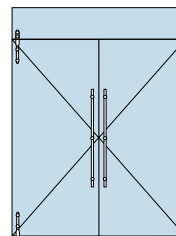

Assembly type 18

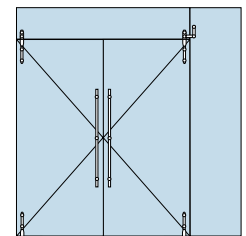

Assembly type 21  
+ 1 x Set 1  
+ 1 x Set 3

Set 3

Satin  
stainl  
steel  
(700)

Art. No.	Description	€/Piece
----------	-------------	---------

Complete sets

**Pivot door MANET COMPACT with overpanel and sidelight for 10 – 12 mm glass**



**29.914** SET 3 with **countersunk** single-point fixings

consisting of:  
Pair of top/bottom pivot poles, short type

incl.  
4 Single-point fixings for pivot poles,  
1 Top pivot bearing,  
1 Overpanel/sidelight connector with pivot bearing location,  
1 Bottom pivot bearing for DORMA BTS and floor bearing

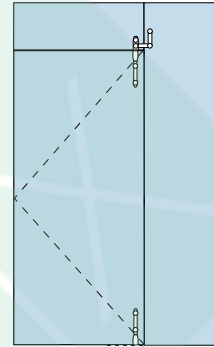

443,00

**29.915** Set as above, but for additional connecting tube in fixed length for pair of top/bottom pivot poles with countersunk single-point fixings

478,00



**29.555** **Not covered by the set:**  
Connecting tube in fixed length  
Length to be indicated when ordering.  
Calculation of fixed length:

Panel height \_\_\_\_\_ mm  
- 577 mm  
= Length of connecting tube  
\_\_\_\_\_ mm

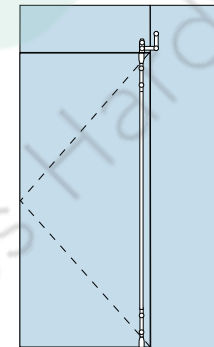

€/m  
35,00

Application example for SET 3

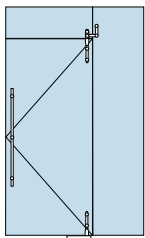

Assembly type 13

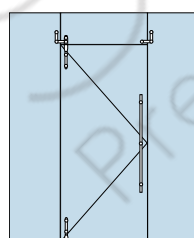

Assembly type 15  
+ 1 Overpanel sidelight connector

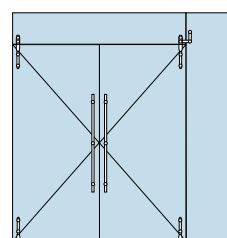

Assembly type 21  
+ 1 x Set 2  
+ 1 x Set 3

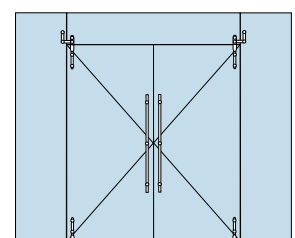

Assembly type 23







## Accessories

Base parts  
(000)  
Satin stainl  
steel  
(700)

Art. No.	Description	€/Piece	€/Piece
	<b>21.448 Dead lock</b> for 8 - 12 mm glass		94,50
	<b>21.449 Dead lock with profile cylinder rose</b> on inside for 8 - 12 mm glass		152,00
	<b>21.450 Dead lock for KABA with rose</b> on inside for 8 - 12 mm glass		125,00
			23,00
	<b>05.194 Eccentric bushing</b> for dead lock 21.448 / 21.449 / 21.450		21,00
	<b>14.206 Profile cylinder</b> for dead lock 21.448 / 21.449		21,00
	<b>05.190 Strike plate</b>		13,50
	<b>29.217</b> 5 pcs. of <b>clip-on cover</b> with spring for single-point fixing <b>29.219</b> do. (AISI 316L)		21,00 29,50
	<b>21.134 Assembling tool for MANET</b> single-point fixings (also usable as nut for torque wrenches)		12,50
	<b>21.137 Hole gauge</b>		20,00
	<b>29.540 Wet room floor pivot</b> with bottom pivot bearing, max. door weight 60 kg (Material AISI 316L)		102,00
	<b>29.335 Door stop at overpanel</b> (indoor/outdoor), for 10/12 mm glass		81,00
	<b>21.334 Stop for pivoting door</b> for ceiling installation		48,00

Components for pivoting doors

Satin  
stainl  
steel  
(700)

Art. No.	Description	€/Piece
	<b>29.551</b> Pivot pole, drilled, fixed length	€/m 181,00
<b>29.552</b>	do. (AISI 316L)	260,00
<b>29.553</b>	Pivot pole, drilled, fixed length for RTS pivot bearing 29.314	€/m 236,00
	<b>Single-point fixing, track to glass, starr</b>	
<b>29.460</b>	countersunk, 10/12 mm glass	16,50
<b>29.461</b>	do. (AISI 316L)	22,00
<b>29.450</b>	countersunk, 13.5 - 15.5 mm glass	24,50
<b>29.465</b>	clamping disc, 10/12 mm glass	32,50
<b>29.466</b>	do. (AISI 316L)	51,00
	<b>Single-point fixing, track to glass, centering</b>	
<b>29.462</b>	countersunk, 10/12 mm glass	24,50
<b>29.463</b>	do. (AISI 316L)	31,00
<b>29.455</b>	countersunk, 13.5 - 15.5 mm glass	32,00
<b>29.467</b>	clamping disc, 10/12 mm glass	34,50
	<b>Top/bottom pivot pole set, short type, for 10/12 mm glass including 4 x single-point fixing</b>	
<b>29.546</b>	countersunk	138,00
<b>29.547</b>	do. (AISI 316L)	214,00
	<b>29.560</b> clamping disc	220,00
<b>29.561</b>	do. (AISI 316L)	254,00
	<b>Top/bottom pivot pole set, short type for intermediate tube, for 10/12 mm glass thickness including 4 x single-point fixing</b>	
<b>29.548</b>	countersunk	157,00
<b>29.549</b>	do. (AISI 316L)	257,00
	<b>29.562</b> clamping disc	220,00
<b>29.563</b>	do. (AISI 316L)	289,00
	<b>Intermediate tube Ø 25 mm, fixed length up to 2,000 mm</b>	€/m 35,00
<b>29.557</b>	do. (AISI 316L)	101,00

Glass assemblies



## Components for pivoting doors

Base parts  
(000)  
Satin  
stainl  
steel  
(700)

Art. No.	Description	€/Piece	€/Piece
	<b>21.310</b> Pivot bearing for overpanel and ceiling connection		<b>63,00</b>
	<b>21.319</b> Pivot bearing for ceiling connection, adjustable	<b>100,00</b>	
	<b>21.318</b> do. (AISI 316L)	<b>116,00</b>	
	<b>29.314</b> Pivot bearing for RTS		<b>118,00</b>
	<b>29.545</b> Pivot bearing for DORMA BTS (max. EN 4) / floor pivot		<b>79,50</b>
	<b>29.550</b> Zero position adjustable do. (AISI 316L)		<b>134,00</b>
	<b>29.333</b> Pivot bearing location for overpanel with countersunk single-point fixings for 10/12 mm glass		<b>123,00</b>
	<b>29.353</b> do. (AISI 316L)		<b>187,00</b>
	<b>29.354</b> Pivot bearing location for overpanel with cylindrical bore for rod with countersunk single-point fixings for 10/12 mm glass		<b>149,00</b>
	<b>29.330</b> Overpanel/sidelight connector RH/LH with pivot bearing location, complete assembly with countersunk single-point fixings for 10/12 mm glass		<b>231,00</b>
	<b>29.362</b> do. (AISI 316L)		<b>281,00</b>
	<b>29.356</b> with clamping disc single-point fixings for 10/12 mm glass		<b>273,00</b>
	<b>29.320</b> Overpanel/sidelight connector right/left with countersunk single-point fixings for 10/12 mm glass		<b>149,00</b>
	<b>29.360</b> do. (AISI 316L)		<b>173,00</b>
	<b>29.357</b> with clamping disc single-point fixings for 10/12 mm glass		<b>192,00</b>
	<b>01.115</b> PT 25 pivot, 15 mm Ø, with plug		<b>5,20</b>
	<b>01.117</b> PT 21, pivot with retractable bolt		<b>39,00</b>

Components for pivoting doors

Satin  
stainl  
steel  
(700)

Art. No.	Description	€/Piece
	<b>01.123 PT 24, pivot with fixing plate,</b> material thickness 3 mm, to screw on the ceiling	<b>21,50</b>
	<b>Overpanel/sidelight connector</b> with pivot bearing location, RH 90° angle with countersunk single-point fixings for 10/12 mm glass	<b>266,00</b>
<b>29.328</b>	wall fixing	<b>301,00</b>
<b>29.331</b>	glass fixing	<b>301,00</b>
	<b>Overpanel/sidelight connector with</b> pivot bearing location, LH 90° angle with countersunk single-point fixings for 10/12 mm glass	<b>266,00</b>
<b>29.329</b>	wall fixing	<b>301,00</b>
<b>29.332</b>	glass fixing	<b>301,00</b>
	<b>29.326 Overpanel/sidelight connector,</b> RH, 90° angle, wall fixing, with countersunk single-point fixings for 10/12 mm glass	<b>196,00</b>
	<b>29.327 Overpanel/sidelight connector,</b> LH, 90° angle, wall fixing, with countersunk single-point fixings for 10/12 mm glass	<b>196,00</b>
	<b>Overpanel/sidelight connector RH/LH</b> with countersunk single-point fixings for 10/12 mm glass, with door stop inside (picture)	<b>212,00</b>
<b>29.322</b>	with door stop outside	<b>212,00</b>
	<b>29.950 Stop for pivoting door,</b> floor mounting	<b>32,50</b>
	<b>Stop for pivoting door, wall mounting</b> short	<b>31,00</b>
<b>29.951</b>	long	<b>35,50</b>
<b>29.952</b>		

Glass assemblies

## Single-point fixings

Satin  
stainl  
steel  
(700)

Art. No.	Description	€/Piece
	<b>20.601</b> Single-point fixing Ø 24 glass / wall, adjustable, M6-fixing screw	14,00
	<b>20.611</b> Single-point fixing Ø 24 glass / wall with base flange 4 mm, adjustable, M6-fixing screw	25,00
	<b>Single-point fixing, S32/35 series glass/wall, countersunk</b> <b>not adjustable, fixed distance to wall 6 mm</b>	
<b>29.205</b>	8/10 mm glass	19,00
<b>29.215</b>	12 mm glass	23,00
<b>29.243</b>	13.5 mm glass	24,50
<b>29.247</b>	15 mm glass	26,00
<b>29.251</b>	17.5 mm glass	27,00
	<b>adjustable, fixed distance to wall 8.5 - 11.5 mm</b>	
<b>29.200</b>	8/10 mm glass	28,00
<b>29.210</b>	12 mm glass	32,00
<b>29.240</b>	13.5 mm glass	33,50
<b>29.244</b>	15 mm glass	35,00
<b>29.248</b>	17.5 mm glass	36,00
	<b>adjustable, fixed distance to wall 11.5 - 14.5 mm</b>	
<b>29.201</b>	8/10 mm glass	28,00
<b>29.211</b>	12 mm glass	32,00
<b>29.241</b>	13.5 mm glass	33,50
<b>29.245</b>	15 mm glass	35,00
<b>29.249</b>	17.5 mm glass	36,00
	<b>adjustable, fixed distance to wall 14.5 - 22 mm</b>	
<b>29.202</b>	8/10 mm glass	28,00
<b>29.212</b>	12 mm glass	32,00
<b>29.242</b>	13.5 mm glass	33,50
<b>29.246</b>	15 mm glass	35,00
<b>29.250</b>	17.5 mm glass	36,00

Single-point fixings

Satin  
stainl  
steel  
(700)



Art. No.	Description	€/Piece
	<b>Single-point fixing, S32/35 series glass/wall, clamping disc</b>	
	<b>not adjustable, fixed distance to wall 6 mm</b>	
29.730	8/10 mm glass	23,00
29.731	12 mm glass	27,50
29.732	13.5 mm glass	29,50
29.733	15 mm glass	31,00
29.734	17.5 mm glass	32,50
	<b>adjustable, fixed distance to wall 8.5 - 11.5 mm</b>	
29.700	8/10 mm glass	34,00
29.705	12 mm glass	38,50
29.710	13.5 mm glass	39,50
29.715	15 mm glass	41,50
29.720	17.5 mm glass	43,00
	<b>adjustable, fixed distance to wall 11.5 - 14.5 mm</b>	
29.701	8/10 mm glass	34,00
29.706	12 mm glass	38,50
29.711	13.5 mm glass	39,50
29.716	15 mm glass	41,50
29.721	17.5 mm glass	43,00
	<b>adjustable, fixed distance to wall 11.5 - 14.5 mm</b>	
29.702	8/10 mm glass	34,00
29.707	12 mm glass	38,50
29.712	13.5 mm glass	39,50
29.717	15 mm glass	41,50
29.722	17.5 mm glass	43,00

## Connectors

Satin  
stainl  
steel  
(700)

Art. No.	Description	€/Piece
	<b>Pivoting glass clamp inclusive screw sets</b> for 8 - 12, 13.5 - 17.5 and 17.5 - 21.5 mm glass countersunk	27,50
29.160	do., clamping disc	36,00
29.165		
	21.141 <b>Pivoting wall fixing</b>	34,50
	29.149 <b>Clamping connector</b> for 8 - 12 mm glass	59,00
	<b>Connecting rods</b> 21.355 Length 52.5 mm 21.356 Length 60 mm 21.357 Length 82 mm 21.358 Length 103 mm	22,00 22,00 22,00 22,00
	21.146 <b>Column ceiling/floor fixing</b>	43,00
	29.145 <b>Glass/ceiling or glass/floor connector 90°</b> , for 8 - 12 mm glass (only supporting, no carrying function)	64,50
	<b>Ceiling connector (carrying function max. 35 kg/piece)</b> for 8 - 12 mm glass	
29.337	with countersunk single-point fixing do. (AISI 316L)	101,00
29.339		159,00
	29.338 with clamping disc single-point fixing do. (AISI 316L)	106,00
29.340		165,00
	<b>Glass/glass corner connector</b> 90°-180°, for 8 - 12 mm glass, with connecting rod	
29.120	52.5 mm	78,00
29.122	60 mm	78,00
29.125	82 mm	78,00
29.130	103 mm	78,00
	<b>Glass/wall corner connector</b> 90°-180°, for 8 - 12 mm glass, with connecting rod	
29.139	52.5 mm	83,50
29.140	60 mm	83,50
29.142	82 mm	83,50

# Wall connecting profiles



Technical data	
Glass	TSG
Glass thickness	8 - 19 mm
max. door panel weight	15 kg each clamp piece
Applications	To fix overpanels and sidelights
Material	Stainless steel, Aluminium
Finishes	Anodised- and RAL-Colors (coated), stainless steel
Specials	Realisation for toughened glass assemblies Simple installation



## Fittings for toughened glass assemblies

- |            |   |  |
|------------|---|--|
| <b>284</b> | <b>MUNDUS Comfort</b>                                   | <b>General accessories for toughened glass assemblies</b>                                |
| <b>294</b> | <b>MUNDUS Premium</b>                                   | <b>387</b> Clamping fitting, U-profile   |
| <b>304</b> | <b>UNIVERSAL</b>  | <b>388</b> Pivot bearing, floor bearing, strike plates, floor sockets, profile cylinders |
| <b>316</b> | <b>UNIVERSAL Arcos</b>                                  | <b>391</b> Locking unit for toughened glass assemblies                                   |
| <b>322</b> | <b>UNIVERSAL light</b>                                  |  |
| <b>326</b> | <b>BEYOND</b>   |  |
| <b>330</b> | <b>EA-Patch fittings for single action doors</b>        |  |
| <b>338</b> | <b>Door rails</b>                                       |  |
| <b>354</b> | <b>MANET Compact/Concept, Single action doors</b>       |  |
| <b>366</b> | <b>Wall connecting profiles</b>                         |  |
| <b>372</b> | <b>Frame systems MR 22 &amp; MR 28</b>                  |  |
| <b>376</b> | <b>DORMA SG – Centre and corner locks, strike boxes</b> |  |

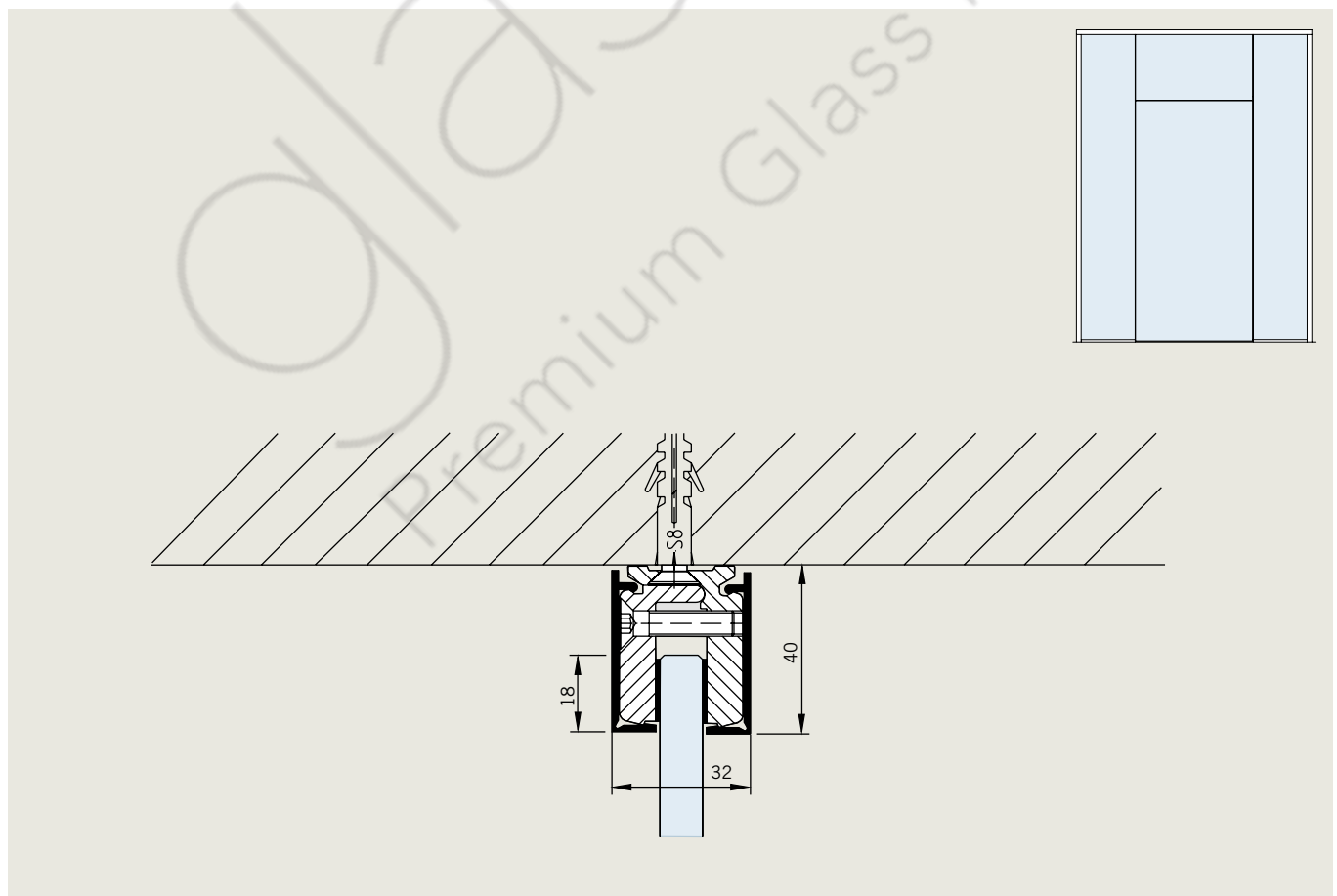
### Example view for wall connecting profile



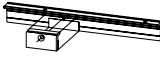
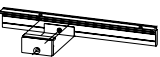



Single components

Art. No.	Description	Base parts (000) €/m	AL mill finish (100) €/m	AL silver anod (150) €/m	AL traffic white p-coat (300) €/m	AL niro anod (157) €/m	Satin stainl steel (700) Polish stainl steel (701) €/m	AL special color anod (199) €/m	AL special color p-coat (399) €/m
	<b>Base profile</b> with fixing holes, incl. clamping parts with screws and gasket strips, <b>6000 mm stock length</b>								
07.042	Base rail for 8 mm glass thickness	50,00							
07.001	Base rail for 10 mm glass thickness	46,00							
07.002	Base rail for 12 mm glass thickness	53,00							
07.045	Base rail for 12,7 mm glass thickness	57,00							
07.046	Base rail for 13,5 mm glass thickness	57,00							
07.047	Base rail for 15 mm glass thickness	57,00							
07.048	Base rail for 17 mm glass thickness	57,00							
07.049	Base rail for 19 mm glass thickness	57,00							
	<b>Toleranz of glass thickness +/- 0,5 mm</b>								
	<b>Base profile</b> with fixing holes, <b>as safety application</b> on borehole glass preparation incl. clamping parts with screws and gasket strips <b>6000 mm stock length</b>								
07.060	Base rail for 8 mm glass thickness	55,50							
07.061	Base rail for 10 mm glass thickness	51,00							
	<b>Cover profile</b> 6000 mm stock length	7,30	9,00	9,00	15,00	17,50	15,00	15,00	
	<b>Filler block for wall connecting profile</b> (10 x 12 mm) 6000 mm stock length	8,00	8,40		14,00		14,00	14,00	



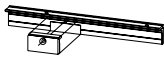



Glass assemblies



Single components

Art. No.	Description	Base parts (000)	AL mill finish (100)	AL silver anod (150)	AL traffic white p-coat (300)	AL niro anod (157)	Satin stain steel (700) Polish stain steel (701)	AL special color anod (199)	AL special color p-coat (399)
		€/m	€/m	€/m	€/m	€/m	€/m	€/m	€/m
 <p><b>Base profile</b> with fixing holes, incl. clamping parts with screws and gasket strips, <b>fixed length</b></p>									
07.050	Base rail for 8 mm glass thickness	63,00							
07.051	Base rail for 10 mm glass thickness	57,50							
07.052	Base rail for 12 mm glass thickness	67,50							
07.055	Base rail for 12,7 mm glass thickness	69,50							
07.056	Base rail for 13,5 mm glass thickness	69,50							
07.057	Base rail for 15 mm glass thickness	69,50							
07.058	Base rail for 17 mm glass thickness	69,50							
07.059	Base rail for 19 mm glass thickness	69,50							
<p><b>Toleranz of glass thickness +/- 0,5 mm</b></p>									
 <p><b>Base profile</b> with fixing holes, <b>as safety application</b> on borehole glass preparation incl. clamping parts with screws and gasket strips <b>fixed length</b></p>									
07.066	Base rail for 8 mm glass thickness	70,50							
07.067	Base rail for 10 mm glass thickness	64,50							
07.053	 <p><b>Cover profile</b> fixed length</p>	8,80	11,50	11,50	18,00	22,50	18,00	18,00	
07.054	 <p><b>Filler block for wall connecting profile</b> (10 x 12 mm) fixed length</p>	9,90	10,50		17,00		17,50	17,50	

Single components

Art. No.	Description	Base parts (000)	AL mill finish (100)	AL silver anod (150)	AL traffic white p-coat (300)	AL niro anod (157)	Satin stainl steel (700) Polish stainl steel (701)	AL special color anod (199)	AL special color p-coat (399)
		€/Piece	€/Piece	€/Piece	€/Piece	€/Piece	€/Piece	€/Piece	€/Piece
<b>Additional clamping part with screw and gasket</b>									
	<b>07.043</b> Base rail for 8 mm glass thickness	9,30							
	<b>07.004</b> Base rail for 10 mm glass thickness	8,20							
	<b>07.005</b> Base rail for 12 mm glass thickness	9,70							
	<b>07.085</b> Base rail for 12,7 mm glass thickness	12,00							
	<b>07.086</b> Base rail for 13,5 mm glass thickness	12,00							
	<b>07.087</b> Base rail for 15 mm glass thickness	12,00							
	<b>07.088</b> Base rail for 17 mm glass thickness	12,00							
	<b>07.089</b> Base rail for 19 mm glass thickness	12,00							
<b>Additional clamping part as safety application on borehole glass preparation incl. clamping parts with screws and gasket strips</b>									
	<b>07.063</b> Clamping part for 8 mm glass thickness	12,00							
	<b>07.064</b> Clamping part for 10 mm glass thickness	10,00							
	<b>07.007</b> End cap for 8 – 10 mm glass thickness	6,50	7,70	7,70	12,50	16,50	12,50	12,50	
	<b>07.044</b> End cap for 12 – 13,5 mm glass thickness	8,50	9,80	9,80	14,50	18,50	14,50	14,50	
	<b>07.065</b> End cap for 15 – 19 mm glass thickness	8,50	9,80			18,50	14,50	14,50	
	<b>07.092</b> U-profile 20 x 20 x 20 x 2 mm Stock length 6000 mm	€/m 4,90	€/m 7,10		€/m 12,00		€/m 12,50	€/m 12,50	
	<b>07.093</b> Fixed length	6,10	8,50		14,50		15,00	15,00	
	<b>07.097</b> U-profile 30 x 20 x 30 x 2 mm Stock length 6000 mm		€/m 9,70		€/m 17,00				
	<b>07.096</b> Fixed length		12,50		21,50				

**Notes**



# MR 22 + MR 28



Technical data	
Glass	TSG
Glass thickness	8, 10 mm
max. door panel weight	No load transmission
Applications	To fix toughened glass elements
Material	Aluminium
Finishes	Anodised-colors ( Alu. silver EV1, Alu. similar satin stainless steel)
Specials	Georgian bar profiles for MR 28, Segmented assemblies with MR 28, Suitable for outdoor assemblies

## Fittings for toughened glass assemblies

- 284** MUNDUS Comfort
- 294** MUNDUS Premium
- 304** UNIVERSAL
- 316** UNIVERSAL Arcos
- 322** UNIVERSAL light
- 326** BEYOND
- 330** EA-Patch fittings for single action doors
- 338** Door rails
- 354** MANET Compact/Concept, Single action doors
- 366** Wall connecting profiles
- 372** Frame systems MR 22 & MR 28
- 376** DORMA SG – Centre and corner locks, strike boxes

### General accessories for toughened glass assemblies



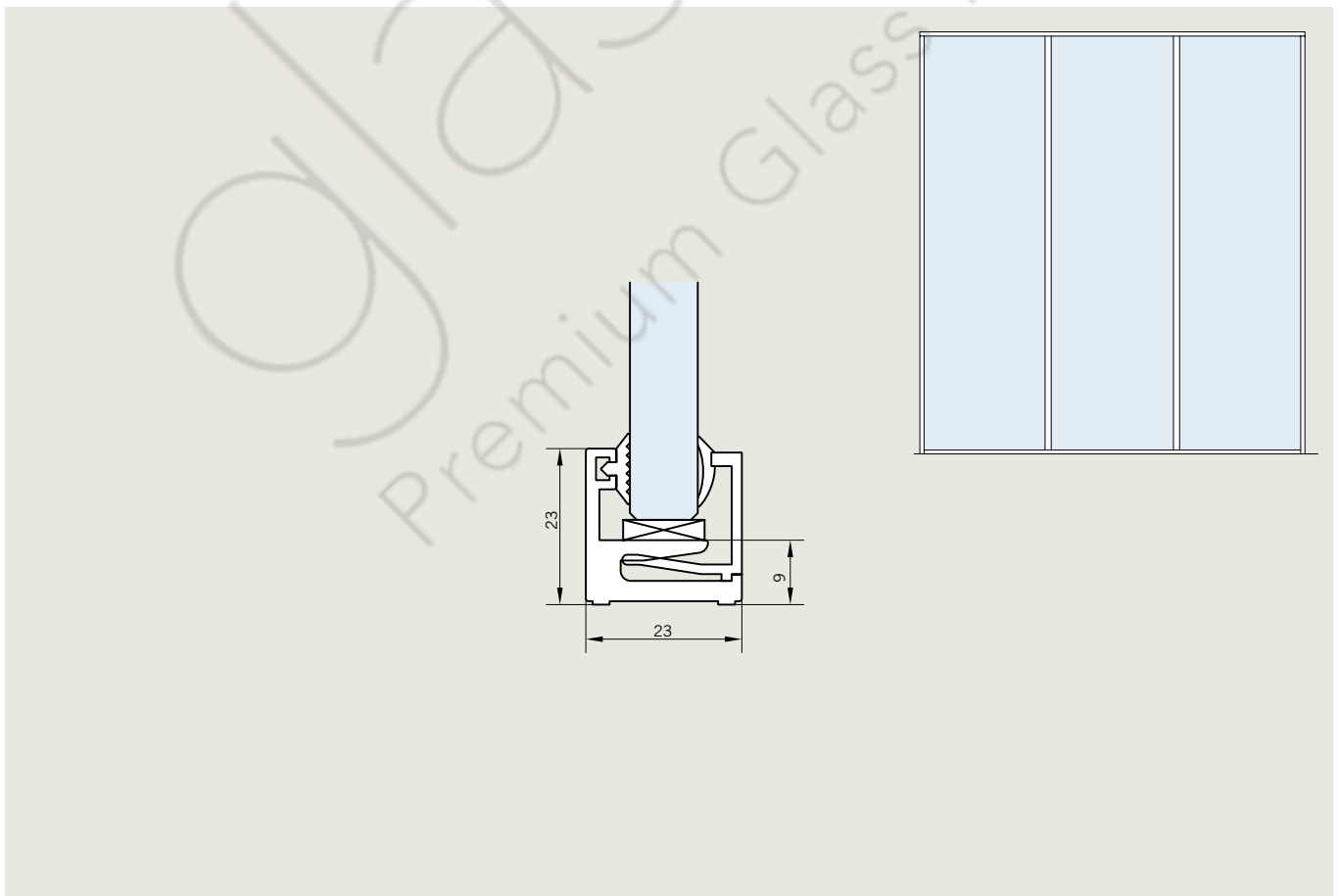

- 387** Clamping fitting, U-profile
- 388** Pivot bearing, floor bearing, strike plates, floor sockets, profile cylinders
- 391** Locking unit for toughened glass assemblies

### Example view for frame system MR 22 / MR 28



Single components

AL mill finish (100)    AL silver EV1 anod (101)    AL sim satin stainl steel anod C31 (113)



Art. No.	Description	€ / m	€ / m	€ / m
	<b>07.240 MR 22 Wall connecting profile</b> glass wedge profile and contact profile have to be ordered separately stock length (6000 mm)	16,50	21,00	33,50
	<b>07.250 MR 22 Wall connecting profile</b> incl. glass wedge and contact profile for 8 mm and 10 mm glass Fix length	30,00	34,50	49,50
	<b>07.241 MR 28 Wall connecting profile</b> glass wedge profile and contact profile have to be ordered separately stock length (6000 mm)	18,50	27,50	37,00
	<b>07.251 MR 28 Wall connecting profile</b> incl. glass wedge and contact profile for 8 mm and 10 mm glass Fixed length	32,00	42,50	53,50
	<b>07.242 MR 28 Georgian bar profile 180°</b> glass wedge profile and contact profile have to be ordered separately stock length (6000 mm)	10,50	13,50	21,50
	<b>07.252 MR 28 Georgian bar profile 180°</b> incl. glass wedge and contact profile for 8 mm and 10 mm glass Fixed length	31,00	34,00	44,00
	<b>07.258 MR 28 Georgian bar profile 90°</b> Stock length (6000 mm)		39,00	54,00
	<b>07.259 MR 28 Georgian bar profile 135°</b> Stock length (6000 mm)		33,50	43,00

**Attention: Profiles are only delivered with straight cuts. Allowances in lengths of profiles to ensure producibility of bevel cuts have to be planned by the customer. The Georgian bar profile must be prepared in addition on both sides. Please consider installation instruction.**

Glass assemblies

Single components

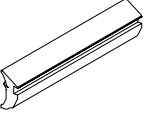
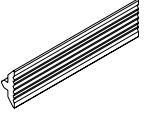
Base parts (000) AL silver EV1 anod (101) AL sim satin stainl steel anod C31 (113)

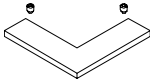
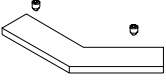
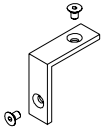
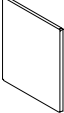
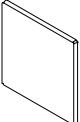
Art. No.	Description	€/Piece	€/Piece	€/Piece
		€/m		
	<b>Glass wedge profile 2 mm</b>			
07.253	fixed length, for 10 mm glass	2,90		
07.263	on 50 m roll, for 10 mm glass	2,80		
	<b>Glass wedge profile 4 mm</b>			
07.254	fixed length, for 8 mm glass	2,90		
07.264	on 50 m roll, for 8 mm glass	2,80		
	<b>Contact profile 2 mm</b>			
07.255	fixed length, for 8/10 mm glass	2,20		
07.265	on 50 m roll, for 8/10 mm glass	2,10		
	<b>Contact profile 4 mm</b>			
07.256	fixed length, for 6/8 mm glass	2,20		
07.266	on 50 m roll, for 6/8 mm glass	2,10		
	<b>07.248 Corner connector for MR 28</b> georgian bar profil 90°		25,00	
	<b>07.249 Corner connector for MR 28</b> georgian bar profil 135°		25,00	
	<b>07.247 MR 28 Corner connection</b> Set of 4 pieces		32,50	
	<b>07.245 End cap MR 22</b>		6,80	8,50
	<b>07.246 End cap MR 28</b>		6,80	8,50

# DORMA SG



Technical data	
Glass	TSG
Glass thickness	8, 10, 12 mm
Lock application	DORMA SG
Applications	1-/2 panels, sidelight, overpanel, toughened glass assemblies
Material	Aluminium, stainless steel, brass
Finishes	Anodised- and RAL-Colors (coated)
Specials	Reliable performance characteristics Selected locks tested acc. to DIN EN 18251 Selected locks for panic solutions



## Fittings for toughened glass assemblies

- 284** MUNDUS Comfort
- 294** MUNDUS Premium
- 304** UNIVERSAL
- 316** UNIVERSAL Arcos
- 322** UNIVERSAL light
- 326** BEYOND
- 330** EA-Patch fittings for single action doors
- 338** Door rails
- 354** MANET Compact/Concept, Single action doors
- 366** Wall connecting profiles
- 372** Frame systems MR 22 & MR 28
- 376** DORMA SG – Centre and corner locks, strike boxes

### General accessories for toughened glass assemblies





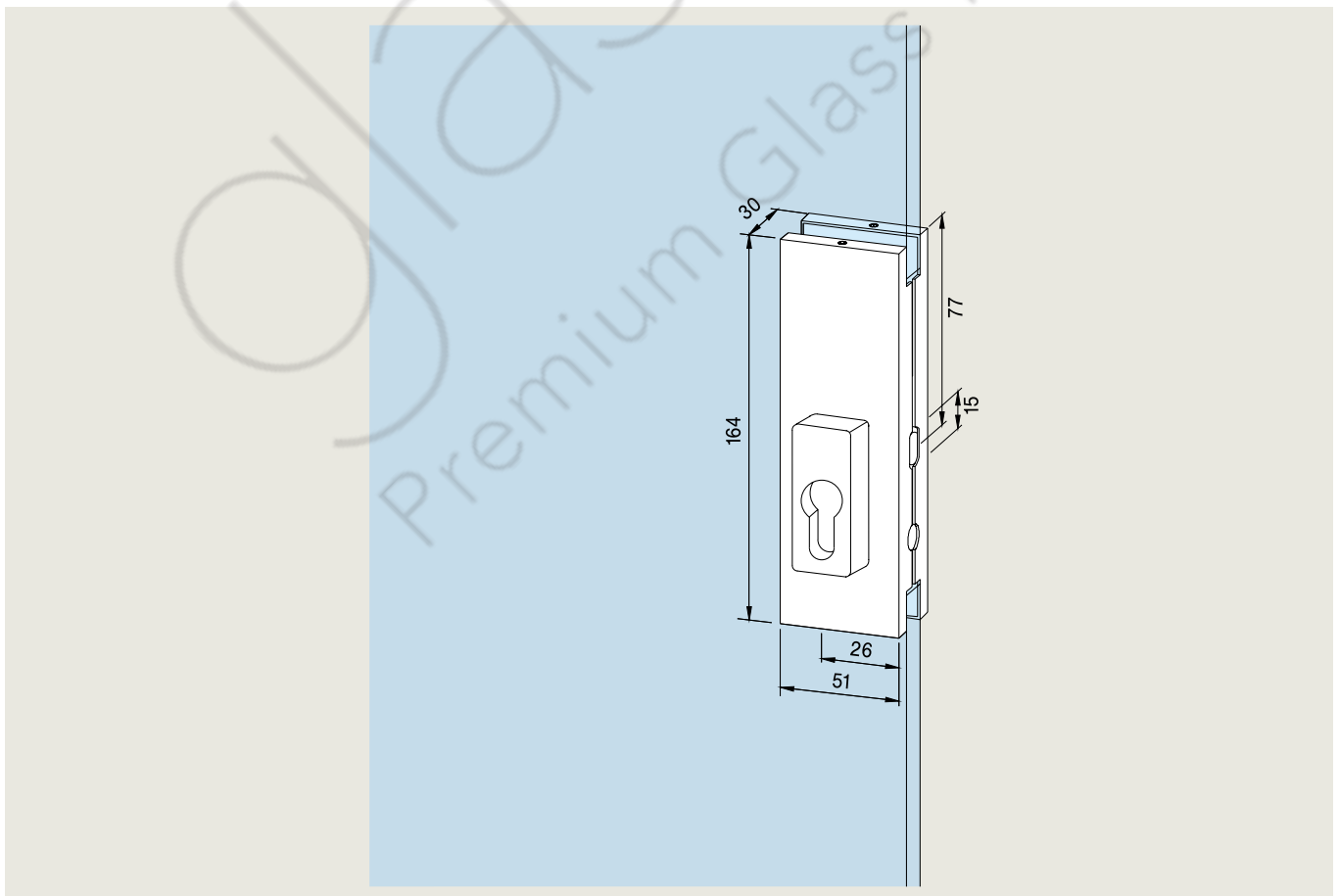

- 387** Clamping fitting, U-profile
- 388** Pivot bearing, floor bearing, strike plates, floor sockets, profile cylinders
- 391** Locking unit for toughened glass assemblies

### Example view for DORMA SG

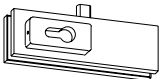
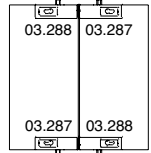





Locks and strike-boxes for 10 mm glass thickness

AL silver EV1 anod (101)    AL traffic white p-coat (300)    Brass polished (503)    Brass polish chromed (501)    Satin stainl steel (700)    Polish stainl steel (701)    AL special color anod (199)    AL special color p-coat (399)

Art. No.	Description	€/Piece	€/Piece	€/Piece	€/Piece	€/Piece	€/Piece	€/Piece	€/Piece	
<b>Single components</b>										
	<b>03.206 US 10 corner lock</b>	89,50	89,50	127,00	150,00	127,00	142,00	125,00	125,00	
	<b>03.288 US 10 corner lock prepared for half profile cylinder</b> -LH top, -RH bottom	89,50	89,50	127,00		127,00	142,00	125,00	125,00	
	<b>03.287</b> do., -LH top, -RH bottom	89,50	89,50	127,00		127,00	142,00	125,00	125,00	
	<b>03.230 GK 30 overpanel strike-box</b>	93,00	93,00		156,00	134,00	148,00	131,00	131,00	
	<b>03.245 GK 20 double overpanel strike-box,</b> consisting of 2 x GK 30 with threaded rod	149,00	149,00			227,00	252,00	211,00	211,00	
	<b>03.250 GK 40 corner overpanel strike-box</b>	111,00	111,00		188,00	159,00	178,00	159,00	159,00	
	<b>03.215 US 20 centre lock</b>	93,50	93,50	135,00	157,00	135,00	149,00	133,00	133,00	
	<b>03.290 US 20 centre lock</b> prepared for half profile cylinder	-LH	93,50	93,50	135,00		135,00	149,00	133,00	133,00
	<b>03.289</b> dto.	-RH	93,50	93,50	135,00		135,00	149,00	133,00	133,00
	<b>03.224 GK 50 strike box</b>	93,00	93,00	134,00	156,00	134,00	148,00	131,00	131,00	

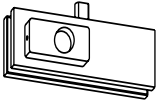
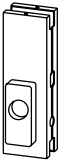
Glass assemblies

## Locks and strike-boxes for 10 mm glass thickness







Art. No.	Description	Finish						
		AL silver EV1 anod (101)	AL traffic white p-coat (300)	Satin stainl steel (700)	Polish stainl steel (701)	AL special color anod (199)	AL special color p-coat (399)	
		€/Piece	€/Piece	€/Piece	€/Piece	€/Piece	€/Piece	
	<b>03.340 US 10, corner lock</b> prepared for KABA cylinder	103,00	103,00		154,00	139,00	139,00	
	<b>03.345 US 20, centre lock</b> prepared for round KABA cylinder	103,00	103,00		154,00	139,00	139,00	
	<b>03.234 GK 30 overpanel strike-box, with stop</b>	- LH	144,00	144,00	168,00	182,00	184,00	184,00
	<b>03.235 do.</b>	- RH	144,00	144,00	168,00	182,00	184,00	184,00
	<b>03.254 GK 40 corner overpanel strike-box, with stop</b>	- LH	160,00	160,00	199,00	218,00	218,00	218,00
	<b>03.255 do.</b>	- RH	160,00	160,00	199,00	218,00	218,00	218,00
	<b>03.247 GK 20 double overpanel strike-box</b> consisting of 2 x GK 30 with threaded rod, with stop		245,00	245,00	309,00	336,00	335,00	335,00

Locks and strike-boxes for 10 mm glass thickness





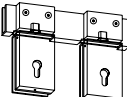

Art. No.	Description	Base parts (000)	AL silver EV1 anod (101)	AL sim satin stainl steel anod (107)	Brass polish chromed (501)	Brass satin chromed (500) Brass polish (503)	AL special color anod (199)	AL special color p-coat (399)
		€/Piece	€/Piece	€/Piece	€/Piece	€/Piece	€/Piece	€/Piece
<b>Single components</b>								
	<b>05.100</b> Corner lock complete for profile cylinder, for 8, 10 and 12 mm glass thickness	81,50	115,00	135,00	121,00	115,00	115,00	
	<b>05.116</b> do., prepared for half profile cylinder, outside blank, inside cylinder hole	92,50	129,00	151,00	138,00	129,00	129,00	
	<b>05.108</b> Strike-box for 05.100 and 05.116. for single doors	46,50			121,00	109,00	74,50	74,50
	<b>05.110</b> do., for double doors	101,00					152,00	152,00
	<b>05.103</b> Corner lock complete for profile cylinder, with shortened counterplate, for 8, 10 and 12 mm glass thickness	96,50	136,00				136,00	136,00
	<b>05.117</b> do., prepared for half profile cylinder, outside blank, inside cylinder hole	106,00					150,00	150,00
	<b>05.109</b> Strike-box for 05.103 and 05.117, with stop, for single doors	63,50					101,00	101,00
	<b>05.111</b> do., with stop, for double doors	129,00					187,00	187,00
	<b>05.106</b> Slide over corner lock prep. for profile cylinder	104,00	150,00				150,00	150,00
	<b>05.112</b> Slide over strike-box for 05.106 and 05.107, for single doors	55,50					84,50	84,50
	<b>05.113</b> Slide over strike-box for 05.106 and 05.107, for double doors	115,00					171,00	171,00
	<b>05.190</b> Lock keeper plate, stainless steel, adjustable	13,50						
	<b>05.192</b> Floor socket	7,00						
	<b>05.193</b> Floor socket, dirt protection	14,50						
	<b>05.194</b> Eccentric socket, adjustable	23,00						

Glass assemblies

**Locks and strike-boxes for 10 mm glass thickness**

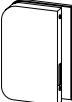
		AL silver EV1 anod (101)	AL sim satin stainl steel anod (107)	AL special color anod (199)	AL special color p-coat (399)
Art. No.	Description	€/Piece	€/Piece	€/Piece	€/Piece
	<b>05.105</b> Corner lock complete prepared for KABA cylinder, for 8, 10 and 12 mm glass thickness	95,50	131,00	134,00	134,00
	<b>05.107</b> Slide over corner lock prepared for KABA cylinder	115,00		166,00	166,00
	<b>05.118</b> Corner lock prepared for profile cylinder, with rose inside	101,00		142,00	142,00
	<b>05.119</b> Corner lock prepared for profile cylinder, with shortened counter plate and rose inside	114,00		160,00	160,00
	<b>For 12 mm glass thickness</b>				
	<b>05.130</b> Slide over corner lock prepared for profile cylinder	107,00		155,00	155,00
	<b>05.131</b> Slide over corner lock prepared for KABA cylinder	119,00		169,00	169,00
	<b>05.132</b> Slide over strike-box for 05.130/05.131, for single doors	56,00		79,50	79,50
	<b>05.133</b> Slide over strike-box for 05.130/05.131, for double doors	118,00		165,00	165,00

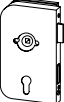
Locks and strike-boxes for 10 mm glass thickness

Art. No.	Description	AL silver anod (150)	AL traffic white p-coat (300)	AL niro anod (157)	Brass polish chromed (501) Brass polish varnished (502)	AL special color anod (199)	AL special color p-coat (399)
		€/Piece	€/Piece	€/Piece	€/Piece	€/Piece	€/Piece
<b>Single components</b>							
	<b>11.216</b> Centre lock for double action doors	- LH 99,50		125,00		180,00	180,00
	<b>11.217</b> do.	- RH 99,50		125,00		180,00	180,00
	<b>11.218</b> Strike-box for 11.217	- LH 83,00		122,00		150,00	150,00
	<b>11.219</b> Strike-box for 11.216	- RH 83,00		122,00		150,00	150,00
	<b>11.220</b> Centre lock for single action doors	- LH 99,50		125,00		180,00	180,00
	<b>11.221</b> do.	- RH 99,50		125,00		180,00	180,00
	<b>11.222</b> Strike-box for 11.221	- LH 83,00		122,00		150,00	150,00
	<b>11.223</b> Strike-box for 11.220	- RH 83,00		122,00		150,00	150,00
	<b>11.200</b> OFFICE Junior lock, prepared for levers with roses	- LH 99,50	99,50	125,00	254,00	180,00	180,00
	<b>11.201</b> do.	- RH 99,50	99,50	125,00	254,00	180,00	180,00
	<b>11.224</b> Centre lock with latch and bolt for single action doors, prepared for handle with rose inside	- LH 99,50		125,00		180,00	180,00
	<b>11.225</b> do.	- RH 99,50		125,00		180,00	180,00
	<b>11.206</b> Strike-box for 11.225 and 11.201	- LH 83,00	83,00	122,00	225,00	141,00	141,00
	<b>11.207</b> Strike-box for 11.224 and 11.200	- RH 83,00	83,00	122,00	225,00	141,00	141,00





Glass assemblies

**Locks and strike-boxes for 8, 10 and 12 mm glass thickness**

		AL silver EV1 anod (101)	AL sim satin stainl steel anod (107)	AL special color anod (199)	AL special color p-coat (399)
Art. No.	Description	€/Piece	€/Piece	€/Piece	€/Piece
	<b>05.210 Centre lock</b> prepared for handle with roses	-LH 181,00	221,00	263,00	263,00
	<b>05.211 do.</b>	-RH 181,00		263,00	263,00
	<b>05.214 Centre lock</b> with follower for door levers	-LH 181,00	221,00	263,00	263,00
	<b>05.215 do.</b>	181,00		263,00	263,00
	<b>05.212 Strike-box</b> for 05.211	-LH 181,00	221,00	263,00	263,00
	<b>05.213 Strike-box</b> for 05.210	-RH 181,00	221,00	263,00	263,00
	<b>05.200 Lock with hook bolt</b> prep. for profile cylinder incl. strike plate suitable for lever handle with roses 10.307 for 8, 10 and 12 mm glass thickness	LH/RH 189,00	246,00	303,00	303,00
	<b>05.202 Lock for sliding doors</b> incl. strike plate, for lever handles without roses for 8, 10 and 12 mm glass thickness	LH/RH 189,00	246,00	303,00	303,00
	<b>05.201 Strike-box</b> for 05.200/05.202	-LH/-RH 189,00	246,00	303,00	303,00

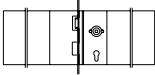

Locks and strike-boxes for 10 mm glass thickness

AL silver EV1 anod (101) AL sim satin stainl steel anod (107) AL special color anod (199) AL special color p-coat (399)

Art. No.	Description		€/Piece	€/Piece	€/Piece	€/Piece
<b>Single components</b>						
	<b>05.220</b>	<b>Centre lock with midrail (800 – 1200 mm),</b> with latch and lock bolt, prepared for handle with roses inside (also available with free glass edge)	- LH	467,00	641,00	641,00
	<b>05.221</b>	do.	- RH	467,00	641,00	641,00
	<b>05.232</b>	<b>Centre lock with midrail (up to 799 mm),</b> with latch and lock bolt, prepared for handle with roses inside (also available with free glass edge)	- LH	368,00	456,00	524,00
	<b>05.233</b>	do.	- RH	368,00	456,00	524,00
	<b>05.222</b>	<b>Strike-box with electric strike release and</b> midrail (800 – 1200 mm), for 05.221/05.233	- LH	845,00	1184,00	1184,00
	<b>05.223</b>	do., for 05.220/05.232	- RH	845,00	1184,00	1184,00
	<b>05.234</b>	<b>Strike-box with electric strike release and</b> midrail (up to 799 mm), for 05.221/05.233	- LH	658,00	767,00	921,00
	<b>05.235</b>	do., for 05.220/05.232	- RH	658,00	767,00	921,00
	<b>05.224</b>	<b>Centre lock with latch and lock bolt</b> prepared for lever with rose inside	- LH	157,00	200,00	226,00
	<b>05.225</b>	do.	- RH	157,00	200,00	226,00
	<b>05.228</b>	<b>Centre lock with latch and lock bolt,</b> prepared for lever with rose / knob for both sides	- LH	176,00	221,00	256,00
	<b>05.229</b>	do.	- RH	176,00	221,00	256,00
	<b>05.226</b>	<b>Strike-box with electric strike release</b> for 05.225/05.229	- LH	467,00	584,00	641,00
	<b>05.227</b>	<b>Strike-box with electric strike release</b> for 05.224/05.228	- RH	467,00	584,00	641,00
	<b>05.230</b>	<b>Midrail, up to 6000 mm length</b>		€/m 309,00	€/m 420,00	€/m 489,00
	<b>05.218</b>	<b>Angle bracket for centre locks</b> (opening to outside, also for locks with panic funtion)	- LH	14,50	18,50	21,00
	<b>05.219</b>	<b>Angle bracket for centre locks</b> (opening to outside, also for locks with panic funtion)	- RH	14,50	18,50	21,00



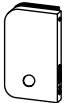
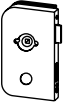
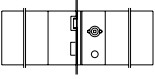
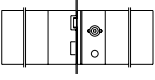
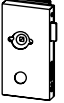

## Locks and strike-boxes for 10 mm glass thickness

			AL silver EV1 anod (101)	AL silver anod (150)	AL niro anod (157)	AL special color anod (199)	AL special color p-coat (399)
Art. No.	Description		€/Piece	€/Piece	€/Piece	€/Piece	€/Piece
<b>Centre locks prepared for KABA cylinder</b>							
	<b>11.250</b> Centre lock for double action doors, prepared for KABA cylinder	- LH	99,50	125,00	180,00	180,00	
	<b>11.251</b> do.	- RH	99,50	125,00	180,00	180,00	
	<b>11.252</b> Centre lock for single action doors, prepared for KABA cylinder	- LH			180,00	180,00	
	<b>11.253</b> do.	- RH			180,00	180,00	
	<b>11.254</b> Centre lock with latch and lock bolt for single action doors, prepared for KABA cylinder	- LH	99,50	125,00	180,00	180,00	
	<b>11.255</b> do.	- RH	99,50	125,00	180,00	180,00	
	<b>05.256</b> Centre lock with midrail (800 – 1200 mm) with latch and lock bolt, prepared for KABA cylinder and handle with roses inside	- LH	467,00		641,00	641,00	
	<b>05.257</b> do.	- RH	467,00		641,00	641,00	
	<b>05.236</b> Centre lock with midrail (up to 799 mm) with latch and lock bolt, prepared for KABA cylinder and handle with roses inside	- LH	362,00		524,00	524,00	
	<b>05.237</b> do.	- RH	362,00		524,00	524,00	
	<b>05.258</b> Centre lock with latch and lock bolt, prepared for KABA cylinder and handle with roses inside	- LH	156,00		226,00	226,00	
	<b>05.259</b> do.	- RH	156,00		226,00	226,00	
	<b>05.218</b> Angle bracket for centre locks (opening to outside, also for locks with panic function)	- LH	14,50		21,00	21,00	
	<b>05.219</b> Angle bracket for centre locks (opening to outside, also for locks with panic function)	- RH	14,50		21,00	21,00	

Glass assemblies



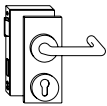
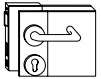

Locks and strike-boxes for 10 mm glass thickness

AL silver EV1 anod (101)	AL sim satin stainl steel anod (107)	AL special color anod (199)	AL special color p-coat (399)
-----------------------------------	--	---	---

Art. No.	Description	€ / Piece	€ / Piece	€ / Piece	€ / Piece
<b>Locks with panic function (opening outside)</b>					
	<b>05.240 Centre lock with latch and lock bolt,</b> with rose handle on inside and fixed knob on outside and profile cylinder roses	- LH	368,00	491,00	487,00 487,00
	<b>05.241</b> do.	- RH	368,00	491,00	487,00 487,00
	<b>05.244 Centre lock with latch and lock bolt,</b> with rose handle on inside and fixed knob on outside, profile cylinder roses, suitable for strikebox and electric strike release 05.227	- LH	409,00		546,00 546,00
	<b>05.245</b> do., for 05.226	- RH	409,00		546,00 546,00
	<b>05.246 Centre lock with latch and lock bolt, with midrail (800 – 1200 mm)</b> with rose handle on inside and fixed knob on outside, profile cylinder roses, suitable for strike-box and electric strike release 05.223/05.235	- LH	780,00		956,00 956,00
	<b>05.247</b> do., for 05.222/05.234	- RH	780,00		956,00 956,00
	<b>05.248 Centre lock with latch and lock bolt, with midrail (up to 799 mm)</b> with rose handle on inside and fixed knob on outside, profile cylinder roses, suitable for strike-box and electric strike release 05.223/05.235	- LH	643,00		788,00 788,00
	<b>05.249</b> do., for 05.222/05.234	- RH	643,00		788,00 788,00
	<b>05.218 Angle bracket for centre locks</b> (opening to outside, also for locks with panic function)	- LH	14,50	18,50	21,00 21,00
	<b>05.219 Angle bracket for centre locks</b> (opening to outside, also for locks with panic function)	- RH	14,50	18,50	21,00 21,00
<b>Not for emergency exit doors according to German standard DIN EN 179 or DIN EN 1125!</b>					









## Clamping fittings, U-profiles

Base parts (000)	AL silver EV1 anod (101)	AL sim satin stain steel anod C31 (113)	AL special color anod (199)	AL special color p-coat (399)
------------------	--------------------------	---	-----------------------------	-------------------------------

Art. No.	Description	€/Piece	€/Piece	€/Piece	€/Piece	€/Piece
<b>U-profile 20 x 20 x 20 x 2 mm</b>						
		(100) €/m	(150) €/m	€/m	€/m	€/m
	<b>07.092</b> Stock length 6000 mm	4,90	7,10	12,00	12,50	12,50
		(150) €/m	(150) €/m	€/m	€/m	€/m
	<b>07.093</b> Fixed length	6,10	8,50	14,50	15,00	15,00
<b>U-profile 30 x 20 x 30 x 2 mm</b>						
		(150) €/m	€/m			
	<b>07.097</b> Stock length 6000 mm		9,70	17,00		
		(150) €/m	€/m			
	<b>07.096</b> Fixed length		12,50	21,50		
<b>Clamping fitting</b>						
<b>Clamping fitting, aluminium, with M6 thread</b>						
	<b>07.008</b> for 8 mm glass thickness		17,00	33,50	33,50	
	<b>07.009</b> for 10 mm glass thickness		17,00	33,50	33,50	
	<b>07.010</b> for 12 mm glass thickness		17,00	33,50	33,50	
	<b>07.020</b> Threaded rod for fixing clamp	3,00				
<b>Clamping fitting</b>						
<b>Clamping fitting, aluminium, with passage hole for M6 thread</b>						
	<b>07.037</b> for 8 mm glass thickness		17,00	31,50	31,50	
	<b>07.038</b> for 10 mm glass thickness		17,00	31,50	31,50	
	<b>07.039</b> for 12 mm glass thickness		17,00	31,50	31,50	





Pivots, lock keeper plates, floor sockets, handle fixings, profile cylinder

Base parts (000)	AL silver EV1 anod (101)	AL traffic white p-coat (300)	Polish stainl steel (701)	Satin stainl steel (700)	AL special color anod (199)	AL special color p-coat (399)
------------------	--------------------------	-------------------------------	---------------------------	--------------------------	-----------------------------	-------------------------------

Art. No.	Description	€/Piece	€/Piece	€/Piece	€/Piece	€/Piece	€/Piece
<b>Pivots, lock keeper plates, floor sockets, handle fixings, profile cylinders</b>							
	<b>01.117 Pivot PT 21</b> with retractable bolt	39,00					
	<b>01.118 Pivot PT 21.1</b> with retractable bolt incl. cover plate	42,50	42,50	45,00	45,00	53,00	53,00
	<b>01.116 Pivot PT 24</b> with fixing plate, material thickness 6 mm, to let into the ceiling	15,00	15,00			22,50	22,50
	<b>01.123 Pivot PT 24</b> with fixingplate, material thickness 3 mm, to screw on the ceiling	14,50	14,50			21,50	21,50
	<b>01.115 Pivot PT 25</b> with threaded rod	5,20					
	<b>01.129 Top pivot bearing</b> nickel plated	11,50					
	<b>01.130 Top pivot bearing</b> aluminium	11,50					
	<b>01.131 Pivot bearing assembly,</b> with steel ceiling fixing plate, for 15 mm bolt	14,50					
	<b>01.132 Pivot bearing assembly,</b> with aluminium ceiling fixing plate, for 15 mm bolt (for wood, aluminium)	14,00	14,00			19,50	19,50
<b>04.601</b>	<b>Pivot pin</b>	7,50					

Glass assemblies

**Pivots, lock keeper plates, floor sockets, handle fixings, profile cylinder**

Art. No.	Description	Base parts (000)	AL silver EV1 anod (101)	AL traffic white p-coat (300)	Brass polish chromed (501) Polish stainl steel (701)	Satin stainl steel (700)	AL special color anod (199)	AL special color p-coat (399)
		€/Piece	€/Piece	€/Piece	€/Piece	€/Piece	€/Piece	€/Piece
<b>Floor bearing</b>								
	<b>01.106</b> Floor pivot bearing with round pivot (stainless steel) and fixing plate	47,00	47,00	56,00	51,00	59,50	59,50	
	<b>01.107</b> Floor bearing	26,00						
	<b>04.602</b> Floor pivot bearing with flat tapered spindle	65,50						
	<b>04.770</b> do., but 2,5 mm enhanced spindle	76,00						
	<b>04.771</b> do., but 5 mm enhanced spindle	76,00						
	<b>04.772</b> do., but 10 mm enhanced spindle	76,00						
	<b>04.773</b> do., but 15 mm enhanced spindle	76,00						
	<b>04.774</b> do., but 20 mm enhanced spindle	76,00						
	<b>04.603</b> Floor bearing with flat tapered spindle version stainless steel	158,00						
	<b>01.136</b> Screw-on floor bearing moistureproof, compl. with insert for door rails, max. 100 kg	58,50						

**Floor sockets, lock keeper plates, floor sockets, profile cylinder**

Art. No.	Description	Finish			
		Base parts (000)	AL silver anod (150)	AL special color anod (199)	AL special color p-coat (399)
		€/Piece	€/Piece	€/Piece	€/Piece
	<b>05.190</b> Lock keeper plate, stainless steel, adjustable	13,50			
	<b>05.192</b> Floor socket	7,00			
	<b>05.193</b> Floor socket, dirt protection	14,50			
	<b>05.194</b> Eccentric socket, adjustable	23,00			
	<b>13.001</b> Single pull handle fixing	28,00	47,00	47,00	
	<b>13.002</b> Back to back pull handle fixing	33,50	55,00	55,00	
	<b>01.136</b> Screw-on floor bearing, moistureproof, without floor insert, complete with insert for door rails, max. 100 kg	58,50			
	<b>05.001</b> Profile cylinder, length 61 mm lang, differently keyed, with DORMA Logo	19,00			
	<b>05.002</b> do., equally keyed	24,50			
	<b>05.003</b> Half profile cylinder length, 31 mm differently keyed, with DORMA Logo	19,00			
	<b>05.004</b> do., equally keyed	23,50			

Glass assemblies

## Locking units

Base parts (000)	AL silver EV1 anod (101)	AL traffic white p-coat (300)	AL special color anod (199)	AL special color p-coat (399)
------------------	--------------------------	-------------------------------	-----------------------------	-------------------------------

Art. No.	Description	€/Piece	€/Piece	€/Piece	€/Piece	€/Piece
04.207	<b>Upper locking unit for double action glass door</b> for installation at door and overhead panel	179,00	175,00	238,00	238,00	
04.208	<b>Upper locking unit for single action glass door</b> for installation at door and overhead panel, outward opening	207,00	196,00	268,00	268,00	
04.209	<b>Upper locking unit for single action glass door</b> for installation at door and overhead panel, inward opening	219,00	209,00	280,00	280,00	
04.210	<b>Upper locking unit for double action glass door</b> for locking into bushing	115,00	120,00	142,00	142,00	
	<b>Cardan crank</b> for upper locking unit for assembly height					
 815.925.000.99	up to 2500 mm	73,00				
815.926.000.99	up to 3000 mm	76,00				
815.927.000.99	up to 3600 mm	85,50				
815.924.000.99	up to 4000 mm	89,50				

Notes









## Levers, handle bars and pull grips



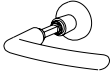
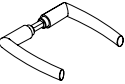
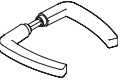







Levers & Handle bars



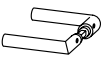
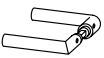





Levers for locks with follower

Art. No.	Description	AL silver anod (150)	AL EV1-Deco anod (114)	AL traffic white p-coat (300)	AL silver brilliant anod (103)	AL brass-colored EV3 anod (105)	AL niro anod (157)	Brass polish chromed (501) Brass polish varnished (502)	AL special color anod (199)	AL special color p-coat (399)
		€/Pair	€/Pair	€/Pair	€/Pair	€/Pair	€/Pair	€/Pair	€/Pair	€/Pair
	<b>24.301</b> Arcos set of levers aluminium/brass		60,00	60,00	66,50	66,50	71,50	98,50	92,50	92,50
	<b>24.316</b> Arcos lever and knob set with Arcos lever and free turnable knob (turnable knob without function)		70,50				76,50			
	<b>24.310</b> Aluminium set of levers Arcos oval	60,00					71,50		92,50	92,50
	<b>24.312</b> Aluminium set of levers Arcos angular	66,50					80,00		98,50	98,50
	<b>Sets of levers for STUDIO Classic</b>									
<b>10.010</b>	Lever for do.	19,50		19,50			27,00		32,50	32,50
	<b>Sets of levers for STUDIO Gala 2.0</b>									
<b>19.009</b>	Lever for do.	38,00		(350) 38,00			52,50		67,50	67,50
	<b>52.330</b> MAME 33						(700) 34,50			
	<b>52.010</b> MAME 01			(507) 34,50						

## Levers for locks with follower





		AL silver anod (150)	AL traffic white p-coat (300)	AL brass-colored EV3 anod (105)	AL niro anod (157)	AL dark bronze DB 14 anod (108)	Satin stainl steel (700)	AL special color anod (199)	AL special color p-coat (399)
Art. No.	Description	€/Pair	€/Pair	€/Pair	€/Pair	€/Pair	€/Pair	€/Pair	€/Pair
<b>Sets of levers for locks with follower</b>									
<b>STUDIO Rondo/Classic/Gala 2.0</b>									
<b>OFFICE Junior/Classic</b>									
	<b>10.314</b> Rondo lever	19,50	19,50	23,50	27,00	23,50		32,50	32,50
	<b>10.304</b> Rondo lever, knob set reversible	48,50	48,50		70,50			89,00	89,00
	<b>11.299</b> Junior lever, satin stainless steel						123,00		
	<b>10.301</b> Tubular lever	46,50	51,50	50,50	52,50	50,50		67,50	67,50
	<b>10.322</b> do. but with stainless steel square drive	56,00			63,00			83,50	83,50
	<b>10.328</b> L-shape lever	(101) 12,50							
	<b>10.329</b> L-shape lever	41,00			41,00				
	<b>10.305</b> Aluminium knob set	31,00	31,00		51,50			59,00	59,00
	<b>10.316</b> Lever and knob set for Rondo/Junior, with tubular lever and free turnable knob for lock without roses (without function)	65,00	65,00		76,50			93,50	93,50
	<b>10.317</b> Lever and knob set for Rondo/Junior, with tubular lever turn knob for lock without roses (with function)	57,50			67,50			83,50	83,50

OGRO levers for locks with follower



Art. No.	Description	AL silver brilliant anod (103) €/Pair	AL sim satin stain steel anod (107) €/Pair	AL traffic white p-coat (300) €/Pair	Satin stain steel (700) €/Pair
<b>OGRO pair of levers incl. pin and adapter*</b>					
	OGRO 8100 90055028427 90055028434 90055028441 90055030642	33,00	42,90	36,30	54,00
	OGRO 8111 90055028442				88,00
	OGRO 8140 90055028443				88,00
	OGRO 8200 90055028444				96,00
	OGRO 8527 90055028428 90055028435 90055028445 90055030643	33,00	42,90	36,30	54,00
	OGRO 8825 90055028429 90055028436 90055028446 90055030644	44,00	57,20	48,40	88,00
	OGRO 8830 90055028430 90055028437 90055028447 90055030645	44,00	57,20	48,40	88,00
	OGRO 8870 90055028448				96,00
	OGRO 8928 90055028449				88,00

\* Please indicate adapter type when ordering.  
The necessary adapter sets are shown on page 397.



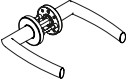
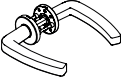

## OGRO levers for locks with follower

Art. No.	Description	AL silver brilliant anod (103)	AL sim satin stainl steel anod (107)	AL traffic white p-coat (300)	Satin stainl steel (700)
		€/Pair	€/Pair	€/Pair	€/Pair
<b>OGRO pair of levers incl. pin and adapter*</b>					
	OGRO 8940 90055028431 90055028438 90055028450 90055030646	44,00		48,40	88,00
			57,20		
	OGRO 8972 90055028432 90055028439 90055028451 90055030647	33,00		36,30	54,00
			42,90		
	OGRO 8999 90055028433 90055028440 90055028452 90055030648	33,00		36,30	54,00
			42,90		
	OGRO 8906 90055028457 90055028458 90055028459 90055030649	33,00		36,30	54,00
			42,90		
	OGRO 8115 90055030654 90055030655 90055030653 90055030688	33,00		36,30	54,00
			42,90		
	* Please indicate adapter type when ordering				
	<b>OGRO 6590</b> Adapter set for using OGRO levers with all locks without roses, shown in this price list, except Arcos locks. Distance ring Ø 27 x 8 mm 90050056714 90050056710 90050056715		9,40	14,30	11,00
	<b>OGRO 6595</b> Adapter set for using OGRO levers with Arcos locks without roses, Distance ring Ø 32 x 8 mm 90050056716 90050056711 90050056717		9,40	14,30	11,00









Levers with roses

		AL silver anod (150)	AL EV1-Deco anod (114)	AL traffic white p-coat (300)	AL niro anod (157)	AL special color anod (199)	AL special color p-coat (399)
Art. No.	Description	€/Pair	€/Pair	€/Pair	€/Pair	€/Pair	€/Pair
	<b>24.307</b> Arcos set of levers	86,00	86,00	99,50	114,00	114,00	
	<b>24.318</b> Arcos lever and knob set with Arcos lever and fixed knob (knob without function)	98,50		108,00			
	<b>24.322</b> Set of levers for wooden doors incl. warded key rose	89,00		102,00			
	<b>24.323</b> Set of levers for wooden doors incl. profile cylinder rose	89,00		102,00			
	<b>24.324</b> Set of levers for wooden doors incl. vacant/occupied indicator	105,00		120,00			
	<b>24.311</b> Aluminium set of levers Arcos oval	86,00		99,50	114,00	114,00	
	<b>24.313</b> Aluminium set of levers Arcos angular	91,00		106,00	114,00	114,00	

## Levers with roses

		AL silver anod (150)	AL traffic white p-coat (300)	AL niro anod (157)	AL special color anod (199)	AL special color p-coat (399)
Art. No.	Description	€/Pair	€/Pair	€/Pair	€/Pair	€/Pair
<b>Levers with roses</b> for locks, STUDIO Rondo/Classic, OFFICE Junior/Classic						
	<b>10.307</b> Tubular levers with roses, aluminium	54,00	64,00	63,00	82,00	82,00
	<b>10.325</b> do. but with stainless steel square drive	64,00		78,00	92,50	92,50
	<b>11.226</b> Aluminium lever handle with roses for locks 11.224/11.225, only for inside	29,50		33,00	40,00	40,00
	<b>10.318</b> Lever and knob set for Rondo/Junior, with tubular lever and fixed knob, with roses (without function)	92,50	92,50	107,00	127,00	127,00
	<b>10.319</b> Lever and knob set for Rondo/Junior, with tubular lever and turn knob, with roses (with function)	84,50		99,50	117,00	117,00

OGRO levers with roses





Art. No.	Description	AL silver brilliant anod (103) €/Pair	AL sim satin stain steel anod (107) €/Pair	AL traffic white p-coat (300) €/Pair	Satin stain steel (700) €/Pair
<b>OGRO pair of levers incl. pin and fixed pivot-mounted OGRO roses with 4 hold springs</b>					
	OGRO 8100 90055000608 90055028408 90055001338 90055030634	54,80		60,30	84,20
	OGRO 8111 90055024557		71,25		118,20
	OGRO 8140 90055022381				118,20
	OGRO 8200 90055024947				126,20
	OGRO 8527 90055000674 90055028412 90055001404 90055030635	54,80		60,30	84,20
	OGRO 8825 90055028406 90055028413 90055028404 90055030636	65,80		72,40	118,20
	OGRO 8830 90055028407 90055028414 90055028405 90055030637	65,80		72,40	118,20
	OGRO 8870 90055023191		85,55		126,20
	OGRO 8928 90055026120				118,20

Please note: OGRO levers with roses are not suitable with locks in the version "unlockable, lever forward" of the series STUDIO Rondo, STUDIO Classic and STUDIO Arcos.

Levers & Handle bars









OGRO levers with roses

Art. No.	Description	AL silver brilliant anod (103) €/Pair	AL sim satin stainl steel anod (107) €/Pair	AL traffic white p-coat (300) €/Pair	Satin stainl steel (700) €/Pair
<b>OGRO pair of levers incl. pin and fixed pivot-mounted OGRO roses with 4 hold springs</b>					
	OGRO 8940 90055004269 90055028417 90055024001 90055030638	65,80		72,40	118,20
			85,55		
	OGRO 8972 90055027493 90055028418 90055026511 90055030639	54,80		60,30	84,20
			71,25		
	OGRO 8999 90055000740 90055028419 90055001470 90055030640	54,80		60,30	84,20
			71,25		
	OGRO 8906 90055000696 90055028456 90055001426 90055030641	54,80		60,30	84,20
			71,25		
	OGRO 8115 90055030657 90055030658 90055030656 90055030685	54,80		60,30	84,20
			71,25		

Please note: OGRO levers with roses are not suitable with locks in the version "unlockable, lever forward" of the series STUDIO Rondo, STUDIO Classic and STUDIO Arcos.

Handle bars

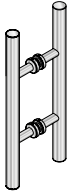
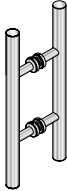
Art. No.	Description	AL silver EV1 anod (101)	AL EV1-Deco anod (114)	AL sim satin stainl steel anod (107)	AL satin stainl steel look (126)	AL polish stainless steel look (127)	AL special color anod (199)	AL special color p-coat (399)
<b>ARCOS handle bar for 8/10/12 mm glass thickness</b> incl. connecting bolt								
	<b>26.500</b>	350 mm with 2 fixings	192,00		271,00	302,00	261,00	261,00
	<b>26.510</b>	750 mm with 2 fixings	231,00		327,00	355,00	319,00	319,00
<b>BEYOND handle bar, for 10 and 12 mm glass thickness</b> two hole fixing								
	<b>30.300</b>	450 mm	278,00		451,00			
	<b>30.305</b>	600 mm	298,00		533,00			
	<b>30.310</b>	900 mm	309,00		578,00			
<b>Handle bar "Square" for 6-10 mm glass thickness</b> two hole fixing								
	<b>75.084</b>	300 mm	226,00	(113)	234,00	(122)	248,00	
	<b>75.085</b>	500 mm	237,00	(113)	252,00	(122)	270,00	
<b>Aluminium pair of handle bars</b> for 8 - 12 mm glass thickness incl. connecting bolt								
	<b>03.400</b>	Length 350 mm with 2 fixings	250,00		255,00			
	<b>03.402</b>	Length 720 mm with 2 fixings	320,00		327,00			
<b>Pair of handle bars for 8 - 13,5 mm glass thickness</b> H-form, with 2 fixings, stainless steel								
	<b>29.291</b>	Length 350 mm		(700)	51,50			
	<b>29.292</b>	Length 550 mm		(700)	62,00			
	<b>29.293</b>	Length 700 mm		(700)	72,00			

Levers & Handle bars

## Handle bars

Satin  
stainl  
steel  
(700)

Art.-Nr.	Description	€/Piece
<b>Pull handle, with countersunk single-point fixing,</b> for 8, 10 and 12 mm glass thickness		
 <b>29.268</b>	350 mm, with 2 fixings	106,00
<b>29.269</b>	do. (AISI 316L)	212,00
<b>29.271</b>	720 mm, with 2 fixings	127,00
<b>29.272</b>	do. (AISI 316L)	222,00
<b>29.274</b>	1,240 mm, with 3 fixings	219,00
<b>29.275</b>	do. (AISI 316L)	269,00
<b>29.277</b>	1,760 mm, with 4 fixings	237,00
<b>29.278</b>	do. (AISI 316L)	348,00
<b>Pull handle, with clamping disc single-point fixing,</b> for 8, 10 and 12 mm glass thickness		
 <b>21.240</b>	350 mm with 2 fixings	111,00
<b>21.241</b>	720 mm with 2 fixings	133,00
<b>21.281</b>	do. (AISI 316L)	250,00
<b>21.242</b>	1,240 mm with 3 fixings	234,00
<b>21.243</b>	1,760 mm with 4 fixings	269,00
<b>21.283</b>	do. (AISI 316L)	437,00
<b>Back to back pull handles incl. connecting bolt</b> for 8, 10 and 12 mm glass thickness		
 <b>21.267</b>	350 mm with 2 fixings	150,00
<b>21.247</b>	do. (AISI 316L)	323,00
<b>21.270</b>	720 mm with 2 fixings	187,00
<b>21.250</b>	do. (AISI 316L)	385,00
<b>21.273</b>	1,240 mm with 3 fixings	336,00
<b>21.253</b>	do. (AISI 316L)	447,00
<b>21.276</b>	1,760 mm with 4 fixings	378,00
<b>21.256</b>	do. (AISI 316L)	533,00
<b>Lockable back to back pull handle</b> for 8 - 13.5 mm glass 1,225 mm, with 2 fixings complete with KESO 2000 lock, 3 keys and floor socket		
 <b>21.279</b>		662,00

Pull grips and door knobs

Art. No.	Description	Base parts (000)	AL silver EV1 anod (101)	AL traffic white p-coat (300)	AL sim satin stainl steel anod C31 (113)	Satin stainl steel (700)	AL special color anod (199)	AL special color p-coat (399)
		€/Piece	€/Piece	€/Piece	€/Piece	€/Piece	€/Piece	€/Piece
	<b>07.200 Recessed pull grip</b> for 8, 10 and 12 mm glass thickness		54,00	54,00	82,00		91,00	91,00
	<b>21.290 Recessed pull grip</b> for 8/10/12 mm glass diameter 50 mm					47,00		
	<b>21.291 Recessed pull grip</b> for 8/10/12 mm glass, diameter 60 mm					70,50		
	<b>Recessed pull grip with grip hole</b> diameter 60 mm							
	<b>21.292</b> for 8 mm glass					86,50		
	<b>21.293</b> for 10 mm glass					87,00		
	<b>21.294</b> for 12 mm glass					87,50		
	<b>21.422 Single door knob</b> for 8/10/12 mm glass with countersunk single-point fixing					74,50		
	<b>21.426 Single door knob</b> for 8/10/12 mm glass with clamping disc single-point fixing					70,50		
	<b>21.423 Back to back door knob</b> for 8/10/12 mm glass					68,00		
	<b>Conversion sets back to back pull handles/door knobs, double-sided, each pull handle fixing</b>							
	<b>21.285</b> set 1, glass thickness 13.5 - 21.5 mm					19,00		
	<b>21.286</b> set 2, timber thickness 20 - 40 mm					25,00		
	<b>Conversion set 3 for pull handle back-to-back to single pull handle, single-sided, each pull handle fixing, for glass and timber doors, 8 - 40 mm thickness</b>							
	<b>21.287</b> with counter sunk					25,50		
	<b>21.288</b> with clamping disc					30,50		
	<b>Conversion set 4 for recessed pull grips</b>							
	<b>21.295</b> for glass doors 13.5 - 21.5 mm thickness					19,50		
	<b>21.296</b> for timber doors 20 - 40 mm thickness					19,50		
	<b>07.201 Door knob</b>		90,50	90,50	133,00		156,00	156,00
	<b>13.005 For sauna doors</b> Wooden handle for Sauna					44,00		
	<b>13.006</b> Wooden snapper block for Sauna					19,00		

Notes



# UNIQUIN

The access and room system with lifestyle character



Technical data	
Color	Graphite, scratch-resistant
Material	Aluminum, powder-coated
Glass/timber installation	10 mm – 19 mm, glass (TSG, LSG of 2 x TSG)
Installation options	Wall, floor, ceiling, inside and outside, corners
Electrification	Integrated cabling
Sound insulation	Sound reduction indices of up to 40 dB, depending on design
Emergency escape/ panic function*	In accordance with EN 179 and EN 1125 * Optional equipment available
Max. door weight	<ul style="list-style-type: none"> <li>• Single action door: 130 kg</li> <li>• Sliding door: 100 kg</li> </ul>
Max. door dimensions	<ul style="list-style-type: none"> <li>• Single action door: 2.950 mm (h) x 1.100 mm (w)</li> <li>• Sliding door: 3.000 mm (h) x 2.000 mm (w)</li> </ul>
Frame profile dimensions	In accordance with the maximum door dimensions

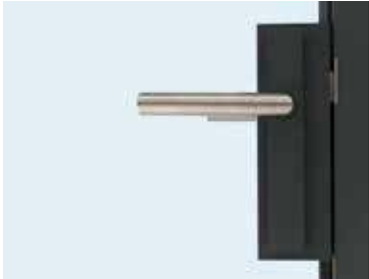

Coordinated, elegant design from the frame to the lever handle



Sliding doors can also be effortlessly integrated



You can combine other dormakaba components such as the TS 97 door closer

Enhance your interior architecture. The system comprises partitions and door solutions that offer coordinated, attractive design coupled with impressive application versatility.

#### Sliding door

Create access points without losing space. With UNIQVIN you can incorporate single or double-panel sliding doors with ease.

#### Room-height single action door

Incorporate door systems measuring up to 3 meters in height. These prestigious access points create a striking impression.

#### Corners

Interconnect your rooms with elegant 90-degree corners to eliminate disruptive vertical posts and thus create more transparency.

#### Electrification

With the aid of special mounting elements, you can flexibly position switches and sockets in the glazing rails or door frame profiles. Integrated cabling ensures an elegant connection to the power circuit every time.

#### Acoustic module

The acoustic modules from UNIQVIN absorb sound waves from within to create a pleasant ambient feel. The fabric covering can be individually printed and backlit\*. Whether it's an eye-catching detail or discreet background – you decide.

#### Sound protection

More transparency, less noise. The decoupled mountings for the glass elements in the profile reduce sound transmission.

#### Single action door

Whether doors of glass for elegance or timber for selective visual privacy, again, the choice is yours. The profile system will hold your chosen material in thicknesses between 10 and 19 mm.

#### Door assemblies in structural openings

You can also use the frame profiles from UNIQVIN for classic single-door solutions, giving a uniform, coordinated look throughout the entire building.

\* Concept and installation by others

**We will be pleased to provide a project-related, individual offer for your concrete building project.**

**To download our order form please visit our website:  
<http://glas-innovationen.com/en/glass-innovations/uniquin>**

Color samples, Mobile presentation module

		€/Piece
	<p><b>8.10.902.000.99</b>    <b>Color samples</b></p> <p><b>Alu. anodised / color coated</b>                      AL silver EV1 anodized (101), AL EV1-Deco anodized (114),                      AL silver brilliant anodized (103), AL brass colored EV3 anodized (105),                      AL brass brilliant anodized (106), AL similar satin stainless steel anodized (107),                      AL dark bronze DB 14 anodized (108), AL silver anodized (Silver N 600 ST) (150),                      AL niro anodized (Niro N 700) (157), AL traffic white powder coated (300)</p>	net <b>22,00</b>
	<p><b>8.10.903.000.99</b>    <b>Brass</b>                      Brass satin chromed (500), Brass polished chromed (501), Brass polished varnished (502)</p>	net <b>22,00</b>
	<p><b>8.10.904.000.99</b>    <b>Stainless steel</b>                      Satin stainless steel (Niro S 700 ST) (700), Polished stainless steel (Niro S 700 HG) (701)</p>	net <b>7,60</b>
	<p><b>8.38.000.100.99</b>    <b>MUNDUS</b>                      AL white powder coated (White P 100 SG) (350), AL silver anodized (Silver N 600 ST) (150)                      Satin stainless steel (Niro S 700 ST) (750), Polished stainless steel (Niro S 700 HG) (751)</p> <p>AL special color anodized (199):                      Dark Niro                      Antique brass                      Black bronze</p> <p>AL special color liquid coated (299):                      Silver semi gloss                      Cast effect                      Champagner                      Bronco                      Dark havanna</p>	net <b>25,00</b>
	<p><b>8.90.003.000.99</b>    <b>Mobile presentation module</b></p> <p><b>Height: 1950 mm (incl. Rollers)</b>  <b>Width: 2000 mm (plus acrylic brochure holders)</b>  <b>Depth: 600 mm</b></p> <p><b>Scope of delivery:</b>                      MUTO XL 80 DORMOTION with MANET handle bar and Quadrat handle bar                      MANET sliding door system with recessed pull grip and single sided handle bar                      STUDIO Arcos with Arcos lever handle                      STUDIO Medio with lever handle OGRO 8928                      OFFICE Junior with lever handle OGRO 8115                      TENSOR glass to glass with Arcos handle bar                      Wall connection profile                      Complete with pre-mounted glass, fittings and lettering</p> <p>Corpus: white                      Incl. rollers, 6 acrylic brochure holders for DIN A 4 format and                      2 sheets of adhesive Logo film</p> <p><b>Surcharge for shipment costs on request.</b></p>	net <b>924,00</b>



Desk samples

AL silver anod (150)    Satin stainl steel (750)    AL EV1-Deco anod (114)

€/Piece    €/Piece    €/Piece

Desk samples

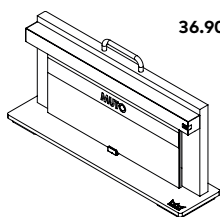

**36.900 Desk sample MUTO**  
MUTO Premium XL 80 incl. DORMOTION  
Frame color: white

net  
**480,00**

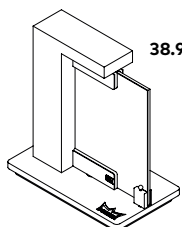

**38.990 Desk sample MUNDUS**  
MUNDUS Comfort PT 10 / PT 20  
Frame color: white

net    net  
**391,00**    **391,00**

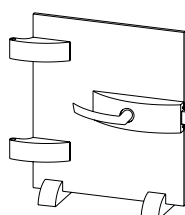

**STUDIO Arcos**  
consisting of  
- 40 x 35 cm glass-panel, incl. wooden base  
- STUDIO Arcos lock, only latch function  
- STUDIO Arcos hinges  
- Arcos lever (follower)

**24.991** Version clear glass

net  
**152,00**

**24.992** Version Satinato glass

net  
**152,00**

**24.993** Version Mastercarree

net  
**152,00**

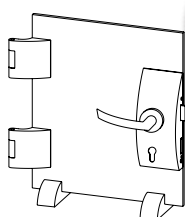

**OFFICE Arcos**  
consisting of  
- 40 x 35 cm glass-panel, incl. wooden base  
- OFFICE Arcos lock prep. for profile cylinder  
- OFFICE Arcos hinges  
- Arcos lever with roses  
- profile-cylinder

**25.991** Version clear glass

net  
**166,00**

**25.992** Version Satinato glass

net  
**166,00**

**25.993** Version Mastercarree

net  
**166,00**

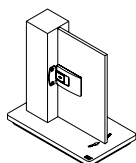

**TENSOR**  
**12.553** Installation onto wall or frame  
with surface mounted mouting plate

net  
**311,00**

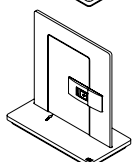

**12.555** Installation glass to glass

net  
**437,00**

Standard finishes and colors		MUTO	RS 120	MANET	RSP 80	STUDIO Rondo	STUDIO Classic	STUDIO Gala 2.0
101	AL silver EV1 anodized (similar Eloxal I EV1 / Eloxal II C 0)		●					
103	AL silver brilliant anodized							
105	AL brass colored EV3 anodized (similar Eloxal I EV 3)					●	●	
107	AL similar satin stainless steel anodized							
108	AL dark bronze DB 14 anodized (similar Eloxal I DB 14/MC 1003 / Eloxal II C 34)					●		
113	AL similar satin stainless steel anodized (for profile material) (similar Eloxal II C 31)		●					
114	AL EV1-Deco anodized (compatible with finish 150)				●			
150	AL silver anodized (Silver N 600 ST) (compatible with finish 114)	●				●	●	●
157	AL niro anodized (Niro N 700)	●				●	●	●
300	AL traffic white powder coated		●			●	●	
350	AL white powder coated (White P 100 SG)	●						●
382	AL graphite scratch resistant powder coated (Graphite P 182 SR)							
500	Brass satin chromed							
501	Brass polished chromed					●		
502	Brass polished varnished					●		
503	Brass polished							
700	Satin stainless steel (Niro S 700 ST)			●				
701	Polished stainless steel (Niro S 700 HG)							
750	Satin stainless steel (Niro S 700 ST) (for MUNDUS)							
751	Polished stainless steel (Niro S 700 HG) (for MUNDUS)							
810	Glass white (Glass G 810 HG)							
880	Glass black (Glass G 880 HG)							

Further finishes for single products are specified on the appr. price list pages.

STUDIO Arcos	STUDIO Medio	OFFICE Junior	OFFICE Classic	OFFICE Arcos	BEYOND	EA Eckbe-schläge	TENSOR	VISUR	MUNDUS Comfort	MUNDUS Premium	UNIVERSAL	UNIQUIN
						•					•	
•												
							•					
					•	•						
							•					
•	•			•	•		•	•				
		•	•						•	•		
•	•	•	•	•								
•		•	•	•							•	
									•	•		
												•
•		•				•					•	
•		•										
						•					•	
		•									•	
											•	
									•	•		
									•	•		
										•		
										•		

Samples

Manual Sliding Doors

Page 15	MUTO Comfort M 50	1 x MUTO Comfort M - 50 Standard-Set, Art. No.: 36.100 1 x Pull handle 350 mm, Art. No.: 21.267 Glass: TSG CLASSICA crystal clear
Page 23	MUTO Comfort L 80	1 x MUTO Comfort L - 80 at glass, Art. No.: 36.304 1 x Pull handle 720 mm, Art. No.: 21.270 + Wall connecting profile Special surface: GREY LINE Glass: TSG CLASSICA crystal clear
Page 59	MUTO Premium XL 80	1 x MUTO Comfort XL - 80 Standard-Set, Art. No.: 36.500 1 x Pull handle 350 mm, Art. No.: 21.267 Glass: TSG CLASSICA crystal clear
Page 95	MUTO Premium Selfclosing 120	1 x MUTO Comfort Selfclosing - 120 Standard-Set, Art. No.: 36.600 1 x Pull handle 350 mm, Art. No.: 21.267 Glass: TSG CLASSICA crystal clear
Page 133	RS 120	2 x RS 120 Set, Art. No.: 07.135 1 x Track profile, Art. No.: 07.131 1 x Cover profile, Art. No.: 07.141 1 x Recesses pull grip, Art. No.: 840201002
Page 145	MANET	2 x MANET Compact Set, Art. No.: 29.918 1 x Laufschienenrohr, Art. No.: 21.436 2 x Pull handle, Art. No.: 21.176 Glass: TSG CONTURA 15
Page 165	RSP 80	1 x RSP 80 Komplett-Set, Art. No.: 30.700 1 x Pull handle, Art. No.: 26.510 Glass: TSG CLASSICA Kristall klar
Page 170	CS 80 MAGNEO	1 x CS 80 MAGNEO Set, Art. No.: 07.501 1 x Switch Art. No.: 19144701170 1 x Recesses pull grip Art. No. 84020100 Glass TSG CLASSICA Satinato

## Manual single action doors

Page 182	STUDIO Rondo	<ul style="list-style-type: none"> <li>1 x STUDIO Rondo Lock, Art. No.: 10.206</li> <li>2 x OFFICE Junior Hinge, Art. No.: 11.230</li> <li>2 x Frame part, Art. No.: 11.405</li> <li>1 x Lever handle, Art. No.: 52.010</li> <li>Glass: TSG Stone I</li> </ul>
Page 190	STUDIO Classic	<ul style="list-style-type: none"> <li>1 x STUDIO Classic Locks, Art. No.: 10.002</li> <li>2 x OFFICE Classic Hinge, Art. No.: 11.288</li> <li>2 x Frame part, Art. No.: 11.310</li> <li>1 x Lever handle, Art. No.: 10.010</li> <li>Glass: LSG Aurum Shine „black“</li> </ul>
Page 196	STUDIO Gala 2.0	<ul style="list-style-type: none"> <li>1 x STUDIO Gala 2.0 Lock, Art. No.: 19.611</li> <li>2 x OFFICE Arcos Hinge, Art. No.: 25.230</li> <li>2 x Frame part, Art. No.: 11.309</li> <li>1 x Lever handle, OGRO 8115</li> <li>Glass: LSG Intermezzo Special</li> </ul>
Page 202	STUDIO Arcos	<ul style="list-style-type: none"> <li>1 x STUDIO Arcos Lock, Art. No.: 24.201</li> <li>2 x OFFICE Arcos Hinge, Art. No.: 25.230</li> <li>2 x Frame part, Art. No.: 11.310</li> <li>1 x Lever handle, Art. No.: 24.301</li> <li>Glass: LSG Aurum Shine „white“</li> </ul>
Page 210	STUDIO Medio	<ul style="list-style-type: none"> <li>1 x STUDIO Medio Lock, Art. No.: 10.501</li> <li>2 x OFFICE Arcos Hinge, Art. No.: 25.230</li> <li>2 x Frame part, Art. No.: 11.310</li> <li>1 x Lever handle, Art. No.: 24.303</li> <li>Glass: LSG Crash I</li> </ul>

## Manual single action doors

Page 214	OFFICE Junior	1 x OFFICE Junior Lock, Art. No.: 11.200 2 x OFFICE Junior Hinge, Art. No.: 11.230, 2 x Frame part, Art. No.: 11.309 1 x Lever handle, Art. No.: 10.307, Glass: TSG Satinato
Page 220	OFFICE Classic	1 x OFFICE Classic Lock, Art. No.: 11.284 2 x OFFICE Classic Hinge, Art. No.: 11.288, 2 x Frame part, Art. No.: 11.309 1 x Lever handle, Art. No.: 11.299, Glass: TSG Satinato
Page 226	OFFICE Arcos	1 x OFFICE Arcos Lock, Art. No.: 25.204, 3 x OFFICE Arcos Hinge, Art. No.: 25.230 3x Frame part, Art. No.: 11.405, 1 x Lever handle, Art. No.: 24.301 + Wall connecting profile, Glass: TSG CLASSICA crystal clear
Page 236	PORTEO	1 x Complete-Set, Art. No.: 12.350, 1 x STUDIO Arcos Lock, Art. No.: 24.201 2 x STUDIO Arcos Hinge Art. No.: 24.230, 1 x Door opener, Art. No.: 12.352 1 x Sliding block, Art. No.: 12.351, 2 x Frame part, Art. No.: 10.424 1 x Lever handle, Art. No.: 24.301 Glass: TSG CLASSICA crystal clear

Glass  
Premium Glass Hardware

**Manual double action doors**

Page 272

TENSOR

2 x TENSOR Hinge, Art. No.: 12.520  
4 x Door stopper, Art. No.: 29.950  
1 x Pull handle, Art. No.: 26.500  
Glass: TSG Ceramica OFFICE 14

Page 276

VISUR

1 x Complete-Set, Art. No.: 03.770  
1 x Pull handle, Art. No.: 26.510  
Glass: TSG CLASSICA crystal clear

glass  
Premium Glass Hardware



## Fittings for toughened glass assemblies

Page 284	MUNDUS Comfort	<ul style="list-style-type: none"> <li>1 x PT 10, Art. No.: 38.100</li> <li>1 x PT 20, Art. No.: 38.200</li> <li>1 x PT 40, Art. No.: 38.400</li> <li>1 x PT 60, Art. No.: 38.600</li> <li>1 x Floor pivot, Art. No.: 01.106</li> <li>+ Wall connecting profile (side + top)</li> <li>+ U-Profile (bottom)</li> <li>Glass: TSG CLASSICA crystal clear</li> </ul>
Page 294	MUNDUS Premium	<ul style="list-style-type: none"> <li>1 x PT 10, Art. No.: 42.100</li> <li>1 x PT 20, Art. No.: 42.200</li> <li>1 x PT 40, Art. No.: 42.400</li> <li>1 x PT 60, Art. No.: 42.600</li> <li>1 x Floor pivot, Art. No.: 01.106</li> <li>+ Wall connecting profile (top)</li> <li>+ U-Profile (bottom)</li> <li>Glass: TSG CLASSICA crystal clear</li> </ul>
Page 304	UNIVERSAL	<ul style="list-style-type: none"> <li>2 x PT 10, Art. No.: 03.100,</li> <li>2 x PT 20, Art. No.: 03.110</li> <li>2 x PT 40, Art. No.: 03.140,</li> <li>2 x Floor pivot, Art. No.: 01.306</li> <li>2 x Pull handle, Art. No.: 21.273</li> <li>+ Wall connecting profile (side + top),</li> <li>+ U-Profile (bottom)</li> <li>Glass: TSG CLASSICA crystal clear</li> </ul>
Page 316	UNIVERSAL Arcos	<ul style="list-style-type: none"> <li>2 x PT 10, Art.-No.: 26.100</li> <li>2 x PT 20, Art.-No.: 26.110</li> <li>2 x PT 40, Art.-No.: 26.140</li> <li>2 x US 10, Art.-No.: 26.206</li> <li>1 x GK 20, Art.-No.: 26.245</li> <li>2 x Pair of pull handles, Art.-No.: 26.510</li> <li>+ Wall connecting profile (side + top),</li> <li>+ U-Profile (bottom)</li> <li>Glass: TSG CLASSICA crystal clear / partly-satined</li> </ul>
Page 326	BEYOND	<ul style="list-style-type: none"> <li>1 x Complete-Set, Art. No.: 30.110,</li> <li>1 x Overpanel connector, Art. No.: 30.130</li> <li>1 x Floor pivot, Art. No.: 01.106,</li> <li>1 x Glass connector, Art. No.: 30.120</li> <li>1 x Pull handle, Art. No.: 30.310</li> <li>+ Wall connecting profile</li> <li>Glass: TSG CLASSICA crystal clear</li> </ul>
Page 354	MANET	<ul style="list-style-type: none"> <li>1 x Complete-Set, Art. No.: 29.912,</li> <li>1 x Side light connector, Art. No.: 29.320</li> <li>1 x US 20, Art. No.: 03.224,</li> <li>1 x GK 50, Art. No.: 03.224</li> <li>1 x Pull handle, Art. No.: 21.267,</li> <li>Glass: TSG CLASSICA crystal clear</li> </ul>
Page 366	Wall connecting profile	<ul style="list-style-type: none"> <li>2 x PT 10, Art. No.: 03.100,</li> <li>2 x PT 20, Art. No.: 03.110</li> <li>2 x PT 40, Art. No.: 03.140,</li> <li>2 x Floor pivot, Art. No.: 01.306</li> <li>2 x Pull handle, Art. No.: 21.273</li> <li>+ Wall connecting profile (side + top),</li> <li>+ U-Profile (bottom)</li> <li>Glass: TSG CLASSICA crystal clear</li> </ul>





**Notification for returns**

In case of returns please get in touch with your local contact.

**Dear Sir or Madam,**  
**please consult us about each return in advance and**  
**enclose this note with the return.**  
**Thank you very much.**

Sender / Returns arranged by::

Customer's No. \_\_\_\_\_ Date \_\_\_\_\_

Contact person (in case of query): Name, Tel No. \_\_\_\_\_

**Please note:** For agreed repurchases of standard stock products (not older that 3 months) we will charge a handling fee of min. 20 % of the value of goods. Returns of used products, customer-specific products (special fabrications: fixed lengths, special colors etc.) and goods that do not meet the technical standard any more, will not be accepted.

Reason (e.g. 1 or 5a)	Return no.	from order no.	Pos. in order	Article no.	Article description	Quantity

**Reason for return:**

- 1) Incorrectly ordered      2) Return of sample      3) Return of stock articles according to separate list
- 4) Goodwill                      5) Complaint according to following reason

**Reason for complaint (5):**

- a) Wrong article                      b) Product fault                      c) No / incorrect function                      d) Double delivery
- e) Damage of finish (scatch)      f) Condition of finish                      g) Color variance                      h) Packaging defect
- i) Damage / transport damage

Additional remarks: \_\_\_\_\_

\_\_\_\_\_

\_\_\_\_\_

\_\_\_\_\_ Date

\_\_\_\_\_ Signature





dormakaba Deutschland GmbH  
DORMA Platz 1  
58256 ENNEPETAL  
GERMANY  
T +49 2333 793-0  
F +49 2333 793-4950